

THE MANUFACTURE OF  
EXPLOSIVES

VOL. I.

## BOOKS FOR STUDENTS IN ENGINEERING.

- ARNOLD'S STEEL WORKS ANALYSIS. 10s. 6d.  
BLAIR'S CHEMICAL ANALYSIS OF IRON. 16s.  
SUTCLIFFE'S STEAM POWER AND MILL WORK. 21s.  
GUTTMANN'S MANUFACTURE OF EXPLOSIVES. Two VOLS., £2 2s.  
HAWKINS AND WALLIS' THE DYNAMO. 10s. 6d.  
BODMER'S HYDRAULIC MOTORS. 14s.  
KAPP'S ELECTRIC TRANSMISSION OF ENERGY. 10s. 6d.  
PREECE AND STUBBS' MANUAL OF TELEPHONY. 15s.  
SALOMONS' ELECTRIC LIGHT INSTALLATIONS:  
VOL. I.—ACCUMULATORS. 5s. VOL. II.—APPARATUS. 7s. 6d. VOL.  
III.—APPLICATIONS. 5s.  
RUSSELL'S ELECTRIC LIGHT CABLES. 7s. 6d.  
BLAKESLEY'S ALTERNATING CURRENTS. 5s.  
ALLSOP'S ELECTRIC LIGHT FITTING. 7s. 6d.  
POOLE'S PRACTICAL TELEPHONE HANDBOOK. 5s.  
TAYLOR'S RESISTANCE OF SHIPS. 15s.  
HOPKINSON'S (J.) PAPERS ON DYNAMO MACHINERY. 5s.  
SALOMONS' ELECTRIC LIGHT INSTALLATIONS. 6s.  
ANDERSON'S CONVERSION OF HEAT INTO WORK. 6s.  
ALEXANDER'S MODEL ENGINE CONSTRUCTION. 10s. 6d.  
FLETCHER'S THE STEAM JACKET. 7s. 6d.  
FINDLAY'S WORKING OF AN ENGLISH RAILWAY. 7s. 6d.  
MAGINNIS' THE ATLANTIC FERRY. 7s. 6d.  
BOWEN COOKE'S BRITISH LOCOMOTIVES. 7s. 6d.  
PRINCIPLES OF PATTERN-MAKING. 3s. 6d.  
" " FITTING. 5s.  
PRACTICAL IRON-FOUNDING. 4s.  
METAL-TURNING. 4s.  
HELICAL GEARS. 7s. 6d.

LONDON AND NEW YORK: WHITTAKER & CO.



# THE MANUFACTURE OF EXPLOSIVES

A THEORETICAL AND PRACTICAL TREATISE ON THE HISTORY,  
THE PHYSICAL AND CHEMICAL PROPERTIES, AND  
THE MANUFACTURE OF EXPLOSIVES

BY

OSCAR GUTTMANN, Assoc. M. Inst. C.E., F.I.C.

MEMBER OF THE

SOCIETIES OF CIVIL ENGINEERS AND ARCHITECTS OF VIENNA AND BUDAPEST,  
CORRESPONDENT OF THE IMPERIAL ROYAL GEOLOGICAL INSTITUTION OF AUSTRIA, ETC.

IN TWO VOLUMES

VOL. I.

*WITH 147 ILLUSTRATIONS*

WHITTAKER AND CO.,

2, WHITE HART STREET, PATERNOSTER SQUARE, LONDON.

1895.

[All rights reserved.]

- 40146 -

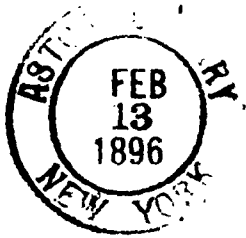

RICHARD CLAY & SONS, LIMITED,  
LONDON & HUNGAY.

ROY WEN  
CLEAN  
WRITING

## PREFACE

WHILST this book was being written, a series of anarchist outrages in various parts of Europe led many Governments to seriously consider the necessity of special legislation to prevent their recurrence. I therefore had also to consider whether the publication of a new book on explosives might not at the time be ill-advised; but the more I thought the matter over, the clearer it became to me that delay was quite unnecessary.

This book is written for manufacturers and experts alone, and anarchists, and such like, will find nothing new in it. On the other hand, there are some fifty thousand workmen employed in Europe alone in the manufacture of explosives, besides many hundreds of thousands to whom the production of good, safe, and cheap explosives is a vital question. It is in the interest of these that, both as an expert and as a citizen, I have written this book.

The first really good handbook appeared in Germany in 1874. It was in two parts—*Gunpowder*, by Dr. G. Upmann, and *Explosive Bodies and Fireworks*, by Dr. E. von Meyer. In 1878 this work was translated into French, and many valuable additions made to it by Mr. E. Désortiaux, and for a very long time these two books were the only available trustworthy sources of information on explosives.

The introduction of the dynamites for civil, and of gun-cotton and picrates for military engineering operations, and the general

adoption of small-bore magazine rifles and smokeless powders completely revolutionized the subject. The above two treatises thus became insufficient and out of date, and the need for a work dealing with the modern developments in explosives more and more urgent.

There are few who, like myself during the last twenty years, have had the opportunity of taking part in every step in the development of the modern explosives industry, and of becoming personally acquainted with the manufacture of almost every explosive and prime material in use, or who have been fortunate enough to be able to personally inspect such a large number of noted factories; and I therefore determined to give my experience for the benefit of others as far as it is of general use, and does not collide with the business interest of manufacturers by whom I have been professionally consulted.

This book, then, is not intended for teaching the manufacture of explosives, nor to make every neophyte an expert manufacturer, but to give trustworthy and detailed advice to experts, whether they be makers or consumers.

Of the excellent works of Drs: Upmann and Meyer and Mr. Désortiaux, I could only utilize very little for this book, and by far the greatest part of it is perfectly new, and in accordance with the most recent practice. The modern explosives, like gun-cotton, dynamite, blasting gelatine, picrates, etc., are here for the first time described and illustrated extensively. Smokeless powders also, although they have practically only been in existence for about six years, and are not yet fully developed, are treated of here as far as their composition and process of manufacture could be ascertained. On the other hand, I have refrained from even mentioning the numerous explosive mixtures which have appeared and also disappeared. They are described *in extenso* in the *Dictionaries of Explosives*, by the late Col. Cundill, Mr. Désortiaux, and Corvette-Captain Salvati.

Wherever possible I have referred to original sources, and

I have made special researches in the history of explosives, with satisfactory results. Since I have satisfied myself of each fact and statement in this book, or knew them from my own experience to be true, I have omitted to make confusing citations of chapter and verse for each word, and preferred to add a general but complete bibliography of explosives.

Finally, I beg to thank most cordially all manufacturers and colleagues who have so kindly assisted me with communications and the privilege of admission to their works, to ask from them the favour of a continuance of the good feeling, and that they will point out any errors which, in spite of all care, may have crept in.

I have also to thank Mr. R. B. Pollitt, Assoc. M. Inst. C. E., who has been, for many years, my assistant engineer in connection with explosives and chemical works, for the able and expert help he has rendered me in preparing this book for the press.

OSCAR GUTTMANN.

1

# CONTENTS

	PAGE
PREFACE ... ..	v
HISTORY ... ..	1
<b>CHAPTER I</b>	
<b>PRIME MATERIALS AND INGREDIENTS OF EXPLOSIVES</b> ... ..	<b>24</b>
<b>1. Potassium Nitrate</b> ... ..	<b>24</b>
<b>I. CRUDE SALTPETRE</b> ... ..	<b>24</b>
<b>II. REFINING OF CRUDE SALTPETRE</b> ... ..	<b>27</b>
(a) <i>Examining the Crude Saltpetre</i> ... ..	<b>27</b>
1. <i>The French method</i> ... ..	<b>27</b>
2. <i>Spandau method</i> ... ..	<b>28</b>
(b) <i>Refining process</i> ... ..	<b>32</b>
1. <i>Spandau process</i> ... ..	<b>32</b>
2. <i>The French process</i> ... ..	<b>34</b>
3. <i>The English process</i> ... ..	<b>35</b>
<b>III. ARTIFICIAL SALTPETRE</b> ... ..	<b>36</b>
<b>IV. EXAMINATION OF SALTPETRE</b> ... ..	<b>38</b>
<b>V. PROPERTIES OF SALTPETRE</b> ... ..	<b>40</b>
<b>2. Sodium Nitrate</b> ... ..	<b>40</b>
Occurrence and refining ... ..	<b>40</b>
Properties ... ..	<b>43</b>
Examination ... ..	<b>43</b>
<b>3. Ammonium Nitrate</b> ... ..	<b>45</b>
<b>4. Barium Nitrate</b> ... ..	<b>49</b>
<b>5. Lead Nitrate</b> ... ..	<b>49</b>
<b>6. Sulphur</b> ... ..	<b>50</b>
(a) <i>Crude sulphur</i> ... ..	<b>50</b>
(b) <i>Refining of sulphur</i> ... ..	<b>53</b>
(c) <i>Examination</i> ... ..	<b>56</b>

	PAGE
<b>7. Charcoal</b> ... .. .	58
Combustibility, 58; yield, 59; yield at varying temperatures, 61; products of decomposition, 63; physical properties, 64; chemical properties, 67; charring, 67; heaps, coppers, etc., 67; cylinders of Le Bouchet, 68; of Waltham Abbey, 69; Maurouard's cylinders, 70; vertical cylinders, 70; charging, 70; yield, 73; quality of charcoal, 73; spontaneous ignition, 75; Violette's process, 78; Kahl's process, 83; Güttler's process, 85; yield in practice, 89; inflammability, 90; selection of wood, 90.	
<b>8. Charcoal made from rye straw</b> ... .. .	90
<b>9. Lamp-black</b> ... .. .	91
<b>10. Wood Pulp</b> ... .. .	91
<b>11. Flour</b> ... .. .	92
<b>12. Cotton</b> ... .. .	92
<b>13. Glycerin</b> ... .. .	94
Crude glycerin, 94; Distillation, 95; Liedbeck's distilling apparatus, 95; yield, 96; glycerin from soap-lyes, 96; Hagemann and Domeier's apparatus, 97; Scott and Son's apparatus, 100; requirements, 101; examination, 101; properties, 103; carriage and storage, 104.	
<b>14. Benzene</b> ... .. .	104
<b>15. Toluene</b> ... .. .	107
<b>16. Naphthalene</b> ... .. .	108
<b>17. Phenol</b> ... .. .	108
<b>18. Cresol</b> ... .. .	109
<b>19. Kieselguhr</b> ... .. .	110
<b>20. Limeguhr</b> ... .. .	115
<b>21. Randanite and other absorbing materials</b> ... .. .	115
<b>22. Alkalies</b> ... .. .	115
<b>23. Ochre</b> ... .. .	116
<b>24. Vaseline</b> ... .. .	116
<b>25. Paraffin Wax</b> ... .. .	117
<b>26. Acetone</b> ... .. .	117
Manufacture, 117; properties, 119; examination, 120.	
<b>27. Ethylic Ether</b> ... .. .	122
<b>28. Acetic Ether</b> ... .. .	125
<b>29. Nitric Acid</b> ... .. .	126
Prime materials, 126; proportions of charging, 127; iron for apparatus, 127; cylinders, 128; troughs, 131; pots, 132; stills, 133; condensation in receivers, 136; Plisson and Devers's condensation, 137; Marchal's condensation, 138; Griesheim process, 139; Valentiner's apparatus, 140;	



	PAGE
Prentice's apparatus, 141 ; Guttman's tube condensation, 145 ; Guttman's air-cooled chamber-pipe battery, 145 ; Guttman-Rohrman's water-cooled battery, 149 ; coker-towers, 151 ; column-towers, 154 ; Lunge-Rohrman's plate-towers, 154 ; working results, 156 ; bleaching, 158 ; pottery joints, 159 ; storing, 160 ; properties, 161 ; examination, 162.	
<b>30. Sulphuric Acid</b> ... ..	167

CHAPTER II

<b>GENERAL PROPERTIES OF EXPLOSIVES</b> ... ..	169
Classification, 169 ; strength, 170 ; heat of combustion, 171 ; temperature of combustion, 172 ; energy, 173 ; gas-pressure, 175.	

CHAPTER III

<b>BLACK POWDER</b> ... ..	176
<b>1. Composition</b> ... ..	176
<b>2. Manufacture</b> ... ..	180
(a) <b>CAKING THE POWDER</b> ... ..	180
(a) <i>Pulverizing, mixing, and caking in one operation</i> ... ..	180
Stamp-mills, 180 ; incorporating-mills, 184.	
(b) <i>Pulverizing each component separately</i> ... ..	185
Incorporating-mills, 185 ; Excelsior mill, 187 ; drums, 189.	
(c) <i>Preliminary mixing</i> ... ..	191
(d) <i>Mixing and caking in stamp-mills</i> ... ..	191
(e) <i>Mixing of the pulverized ingredients</i> ... ..	194
Drums, 194 ; incorporating-mills, 198 ; treatment, 199 ; explosions in incorporating-mills, 200 ; drenching apparatus, 201.	
(f) <i>Pressing the cake</i> ... ..	202
Breaking-down, 202 ; screw-presses, 204 ; roller-presses, 204 ; hydraulic-presses, 206.	
(b) <b>GRANULATING</b> ... ..	210
Lefebure's machine, 211 ; Swiss machine, 215 ; Maurey's drum, 215 ; Champy's drum, 216 ; Congrève's granulating rolls, 217 ; granulating tables, 219 ; rounding, 219.	
(c) <b>DUSTING, PRELIMINARY DRYING, AND GLAZING</b> ... ..	222
(d) <b>DRYING</b> ... ..	224
Drying-rooms, 225 ; drying by cold air, 227 ; by hot, dry air, 228 ; in vacuo, 229 ; moisture in air, 230.	
(e) <b>DUSTING AND FINAL GLAZING</b> ... ..	231
(f) <b>SORTING</b> ... ..	234
(g) <b>BLENDING</b> ... ..	235

	PAGE
<b>3. Compressed Powder</b> .....	236
Zimmermann's cartridge press, 238 ; circular table press, 238 ; prismatic powder, 241 ; Mammoth powder, 243 ; R. L. G. powder, 243 ; pebble powder, 243 ; cubical powder, 243 ; cutting machines, 243 ; Wyschnegradski's press, 245 ; Grusonwerk press, 247 ; principle of the hydraulic press, 247 ; accumulators, 249 ; cup leather, 252 ; Taylor and Challen's prismatic powder press, 252 ; Grusonwerk press, 254 ; drying of prisms, 257 ; pellet powder, 258 ; Du Pont powder, 260 ; Fossano powder, 260	
<b>4. Packing</b> .....	260
<b>5. Re-shaking</b> .....	264

## CHAPTER IV

<b>EXPLOSIVES RELATED TO BLACK POWDER</b> .....	266
<b>1. Powders with substitutes for Saltpetre</b> .....	267
(a) <i>Powders containing sodium nitrate</i> .....	267
(b) <i>Powders containing ammonium nitrate</i> .....	268
(c) <i>Powders containing barium nitrate</i> .....	268
(d) <i>Powders containing potassium chlorate</i> .....	269
<b>2. Powders without Sulphur</b> .....	271
<b>3. Powders with substitutes for Charcoal</b> .....	271

## CHAPTER V

<b>ABSORBING POWDERS FOR DYNAMITE</b> .....	274
---	-----

## CHAPTER VI

<b>GENERAL REMARKS ON BLACK POWDER FACTORIES</b> .....	277
Construction of buildings, 277 ; water-power plant, 278 ; steam-power plant, 278 ; distribution of steam, 280 ; shafting, 281 ; consumption of power, 281 ; cost of production, 281 ; consumption, 282.	

## CHAPTER VII

<b>PROPERTIES OF BLACK POWDER</b> .....	283
<b>1. Physical Properties</b> .....	283
(a) <b>EXTERNAL CONDITIONS</b> .....	283
(b) <b>SOLIDITY OF GRAIN</b> .....	284
(c) <b>SIZE OF GRAINS</b> .....	284
(d) <b>DENSITY</b> .....	285

## CONTENTS

xiii

	PAGE
(a) <i>The Gravimetric Density</i> ... ..	285
(β) <i>The Relative and Absolute Density</i> ... ..	288
1. <i>MARCHAND'S DENSIMETER</i> ... ..	297
2. <i>HOPFMANN'S DENSIMETER</i> ... ..	299
3. <i>BODE'S DENSIMETER</i> ... ..	302
4. <i>BODE'S DENSIMETER WITH A MERCURY AIR-PUMP</i> ... ..	304
5. <i>RICQ'S DENSIMETER</i> ... ..	306
6. <i>BIANCHI'S DENSIMETER</i> ... ..	308
(e) <i>HYGROSCOPIC PROPERTIES OF POWDER</i> ... ..	313
(f) <i>DETERMINATION OF MOISTURE</i> ... ..	316
<b>2. Chemical Examination</b> ... ..	<b>317</b>
(a) <i>QUALITATIVE EXAMINATION</i> ... ..	317
(b) <i>QUANTITATIVE ANALYSIS</i> ... ..	317
1. <i>DRYING THE POWDER</i> ... ..	318
2. <i>DETERMINATION OF SALTPETRE</i> ... ..	318
3. <i>DETERMINATION OF SULPHUR</i> ... ..	320
4. <i>DETERMINATION OF CHARCOAL</i> ... ..	325
5. <i>DETERMINING ALL COMPONENTS SIMULTANEOUSLY</i> ... ..	327
<b>3. Mechanical Properties of Black Powder</b> ... ..	<b>330</b>
(a) <i>INFLAMMABILITY</i> ... ..	330
(b) <i>RAPIDITY OF COMBUSTION</i> ... ..	333
(c) <i>COMBUSTION</i> ... ..	334
(d) <i>PRODUCTS OF COMBUSTION</i> ... ..	336

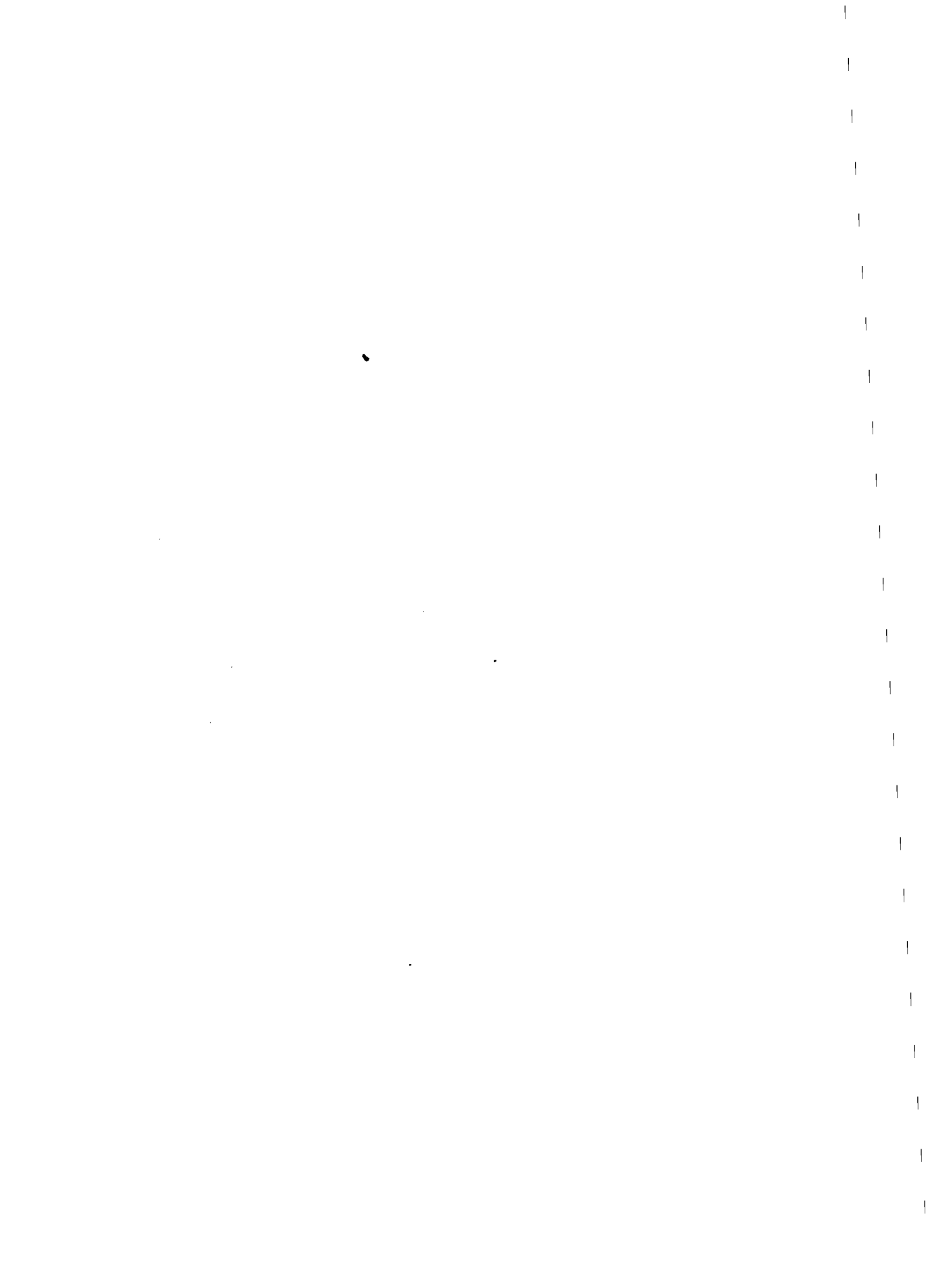

## NOTES TO THE ILLUSTRATIONS

- The figures 1, 15, 16, 80 to 82 incl., 100, 101, 111, 117, 118, 133, 138 to 140 incl., 146, 147, 263 to 266 incl., 270, 271, 273, 274, 277, 278, 281 to 289 incl., 295 to 298 incl., are taken from Dr. J. Upmann, 'Das Schiesspulver.'
- „ „ 169, 175, 176, 245 to 251 incl., from Dr. E. v. Meyer, 'Die Explosivkörper und die Feuerwerkerei.'
- „ „ 3 to 6 incl., 18, 19, 31, 158, 159, 194, 211, 219, 222 from Muspratt, 'Theoretische und praktische Chemie.'
- „ „ 8 to 13 incl., 17, 87, 104, 108, 123, 132, 145, 268, 302, 303 from E. Désortiaux, 'La Poudre, les Corps Explosifs, et la Pyrotechnie.'
- „ „ 20 to 30 incl., 151 to 157 incl., 167, 168 from German patent publications.
- „ „ 32 to 36 incl., 66, 218, 235 to 240 incl., 319, 320 from English patent specifications.
- „ „ 241 from the Austro-Hungarian patent publication.
- „ „ 37, 38 from Dr. G. Lunge, 'Coal Tar Industry.'
- „ „ 149 from Dr. G. Lunge, 'Sulphuric Acid.'
- „ „ 39, 40, 304 to 309 incl., 311, 321, 322 from the 'Mittheilungen des k. k. techn. u. adm. Militär Comité's.'
- „ „ 106, 107, 327, 328 from the 'Mémorial des Poudres et Salpêtres.'
- „ „ 103, 143 from the 'Aide-mémoire à l'usage des Officiers d'Artillerie.'
- „ „ 98, 99, 276 from the 'Preussisches Handbuch für Kriegsfeuerwerkerei.'
- „ „ 86 from Witte, 'Waffenlehre.'
- „ „ 79, 83 from Böckler, 'Theatrum Machinarum Novum.'
- „ „ 269 from Furttenbach, 'Büchsenmeistereischule.'
- „ „ 141, 272, 294 from Post, 'Chemische Technologie.'
- „ „ 211 to 213 incl., from the 'Journal of the Society of Chemical Industry.'
- „ „ 258 to 262 incl., from Karmarsch u. Heeren, 'Technisches Lexikon.'
- „ „ 279, 292, 293 from Maudry, 'Waffenlehre.'
- „ „ 274 from Castner, 'Das Schiesspulver.'
- „ „ 290, 291 from Sebert, 'Essais d'Enrégistrement.'
- „ „ 310 from Quinan, 'Crusher and Cutter Gauges.'
- „ „ 121, 122, 183, 187 to 190 incl., 242 to 244 incl., 323 to 326 incl., from English official publications.
- „ „ 85, 95, 124, 128, 148, 163, 196 to 198 incl., 223, 224 are blocks of the makers.
- Of the remaining 142 figures, 41 were re-drawn from sketches and plans of makers and others, whilst 101 figures were made from own drawings.



# THE MANUFACTURE OF EXPLOSIVES

## HISTORY

No invention, perhaps, has caused such an entire transformation of the whole manner of living of mankind as that of gunpowder. Considering the terrible wars since fought, one might doubt whether Sebastian Münster (in 1544) was not right in saying that "the villain who brought such a noxious thing to earth is not worthy of having his name retained on earth in the memory of man." Still, enlightenment and progress could never have taken root and grown in the semi-barbaric times of the Middle Ages had not a perfected art of war given them efficient support.

The inventor of gunpowder will probably remain unknown for ever, and there are still doubts as to which nation first used it. A history of gunpowder should, therefore, in the first place, consider the probability of its earliest application by the various nations. This will be done in the following pages as far as is consistent with the scope of the work. It is necessary to discuss the matter somewhat closely, as a large number of statements by various writers are known, especially those of the sixteenth century, who wrote either from hearsay or copied other historians and embellished them by fanciful additions, or who gave opinions, which they arrived at by combining various isolated facts, as real events.

Like nearly all important inventions, that of gunpowder has been gradually growing during decades, and this alone makes it impossible to discover the inventor; but if we consider its use as a propelling force only—*i. e.* for throwing projectiles (and this, in the writer's opinion, would be wrong)—even then we can hardly hope to be able to definitely fix the event, since this use has

been gradually evolved from various other applications. It would be equally wrong to affirm with Robins (1783) that gunpowder must have been invented at the same time as, or soon after, saltpetre was discovered. It is fairly well established that the Arabians knew of saltpetre as early as the eighth century, but it is not until the time of Roger Bacon, in the thirteenth century, that we find any mention of the property that saltpetre has of deflagrating with burning bodies.

An Arabian manuscript of the year 1225, which exists in the library of Leyden, entitled 'Treatise of the Ruses of War, the Capturing of Towns and the Defence of Passes; according to the instructions of Alexander, son of Philip,' gives various recipes for incendiary fires, but does not mention saltpetre. The Orientals have frequently imagined that Alexander and Aristotle, whom they believed to be his minister, were the inventors of war-engines.

It seems likewise proved that a mixture very similar to gunpowder was long used for fire-balls, rockets, fire-arrows, etc., before the knowledge of its qualities and its power of doing work led to the invention of means of utilizing it as a propelling agent, *i. e.* of guns and rifles.

The mixture now known to us under the general name of Greek-fire, and called by the ancients "naphtha," was first introduced by Kallinikos of Heliopolis, between 660 and 667, during the defence of Constantinople. Its composition has from time to time undergone improvement at the hands of various artillerymen by the addition of fresh ingredients, and it is not difficult to imagine that besides sulphur, pitch, resin, etc., the addition of saltpetre was in turn tried. This did not enable the burning mass to be thrown to a longer distance, and the desirability of being able to do this probably led to the enclosing of the "fire" in hollow stones, perforated iron vessels, etc., which could be conveniently projected by the throwing-machines. In the naval battle between the Moorish kings of Tunis and Sevilla, in the twelfth century, iron bottles were thrown, evidently from machines, which made much "fire-thunder."

In the Chinese Annals translated by Mailla and Gaubil, it is stated, in the description of the siege of Pian-king and Lo-yang in the year 1232, that "at this time they used the ho-pao or fire-pao, called 'tchin-tien-lui,' or 'thunder which shakes heaven.' They made use of an iron pot for this purpose, which they filled with 'Yo.' (This now means powder, but formerly igniting



mass.) As soon as they lit it the pao rose, and fire originated from all sides. Its noise resembled thunder, and it was heard for more than 100 li; while it could spread fire over a surface of more than half an acre. This fire perforated even iron cuirasses which were struck by them."

Raschid-eddin relates in the year 1258 "that the Mongolians appeared before Bagdad and threw stones, arrows, and vessels filled with naphtha."

Marco Polo tells, in his description of the siege of Sayan-fu and Fan-tching in 1268 to 1273, at which he was present, how "Meser Nicolas" and his son made "mangani" (throwing-machines) which threw stones and fire. In the 'Thong-kiang-kang-mon,' the following account of the event during the same siege is given: "A projectile thrown by these pao hit the town tower where the bell which announced the morning was, and made there a noise resembling thunder" (that is, the noise was made after the projectile had left the pao).

Joinville likewise relates that in 1248 the Saracens carried stone-throwing machines against Ludovic the Saint, which threw Greek-fire. Almarco, Secretary of Almalec Alsalchi, King of Egypt (1279), when speaking of the arms of the Arabians, says: "There the firebrands, which are tied with cords and filled with barud, spin and make noise, by the bursting of which they flash and burn." (Barud originally meant saltpetre, but later powder.) "When the catapult-machine went off, one saw already a cloud spread in the air, which, making noise like a fearful lightning and vomiting fire from all sides, did break, ignite, and incinerate everything."

These and similar accounts have caused much confusion in the works of later historians, as they have been read as implying the use of cannon. If one date did not agree with another that was supposed to be correct, then either the facts were doubted or the dates transposed to make them agree. If, however, it is supposed, as is only natural, that Greek-fire was gradually altered until the addition of saltpetre practically made it into a gunpowder, then all these accounts evidently refer to Greek-fire mixtures only. It was probably introduced into iron, or other strong containing vessels, generally provided with lateral holes, and projected into the enemy's position by throwing-machines. During their flight smoke and fire were developed, the latter igniting anything upon which it fell. The rapidly-developed gaseous products of combustion would naturally create

a noise in issuing from the narrow holes in the vessel, and in the event of a sudden combustion of the mixture in a relatively weak vessel, an explosion might well occur.

In interpreting these accounts, one must not take the various references to bombardæ (*tormentum*), which played a rôle in some sieges, to imply the use of mortars and cannons, because later writers used this term for machines used for throwing fire-balls, etc. Marco Polo, for instance, tells us of cruel battles, war utensils, great festivals, chases, travels, and the arms which the Chinese used in the second half of the thirteenth century, but nowhere does he mention guns or gunpowder in such a sense that their present meaning could be attached to them. Similarly, Ægidius Columna, at the end of the thirteenth century, describes very extensively all arms, including fire-arrows and incandescent balls, which were thrown from iron catapults, etc., but he does not refer to bombardæ as guns. In the writings of Bartolommeo di Ferrara, it is chronicled that Brescia was besieged in 1311 by the Emperor Henry VI., and that the Brescians defended themselves with throwing-machines (*mangani*), stone catapults (*bombardæ*, Latin *tormentum*), wall-breakers (*trabocchi*), and large cross-bows (*balestre*).

The supposition that gunpowder was known before its use in guns was discovered is supported by the older historians. All the components and mixtures for Greek-fire similar to gunpowder were already known in the time of Hassan-al-Rammah (1290), but in 1313 Vassaf, describing the arms, still speaks of naphtha vessels, but not of gunpowder, as the means of shooting.

Yusuf, son of Ismail Aldjuny, wrote about saltpetre (*barud*), in the year 711 of the Hegira (1333 A.D.). He states that "the inhabitants of the Irac use it to produce the fire which tends to rise and move; it increases the fire by facility and quickness of ignition. It is not used elsewhere except as medicine."

Equally well known was the use of a powder-like mixture, which was fixed to the end of arrows and propelled them forward, or supported their flight (fire-arrows).

With this we come to the fourteenth century, at the beginning of which gunpowder was undoubtedly used for artillery purposes. This is not the place to discuss all the evidently incorrect or wrongly understood passages from old writers; but such as have been universally quoted may be examined more closely.

That the Chinese did not invent gunpowder is pretty certain, for the single reason that they were so frightened when three pieces, which the Portuguese of Macao had presented to them, were tried. It is true that there were some pieces at the gates of Nan-king, but they must have been taken in battle, since nobody knew how to handle them. Only after he had tried them was the Jesuit, Adam Scheel, and, later on, Pater Werbies, ordered to make such pieces.

The invention of gunpowder has also been ascribed to the Hindus, and this opinion was based upon two passages in certain Indian law-books, viz. 'A Code of Gentoo-laws,' prepared by Indian savants, by order of Warren Hastings, in the Seventies of last century, and translated into English by Halhed. In this code there is, under the heading of 'Account of the Qualities required by the Authorities,' the following passage: "The Magistrate shall not make war with any deceitful machine, or with poisoned weapons, or with cannons and guns, or any other kind of fire-arms . . ."; and in the chapter on 'Interest' it is said: "If dried grass, fuel, wood, bricks or leaves, or things made of leather or bone; or scimitars, spears, daggers, *muskets*, and this kind of warlike instrument; or dried flowers, or fruit of the worst species, be borrowed and not repaid in fifty months, yet no interest is to be given on them; but if it be originally stipulated it shall be paid."

In the Sanscrit text "*çata-ghna*" stands for the word *gun*, and *agni-astra* for musket. According to a communication from Professor Windisch to Dr. Upman, the above-mentioned words are in fact Sanscrit, but they have been made up to designate things that are never mentioned in the genuine Sanscrit literature. *Agni-s*, Latin *igni-s*, signifies fire, and "astra" means throwing arm, projectile, arrow; so that *agni-astra* means literally fire-projectile, fire-arrow. In the words "*çata-ghna*," "*çata*" means hundred, Greek *ἑκατόν*, Latin *centum*; "*ghna*" means killing, so that "*çata-ghna*" means really "killing hundreds."

By this explanation the passages cited above lose their significance, because it would imply too much to read the modern meaning of gun or fire-arm in the words "killing hundreds" and "fire-arrow." If the Hindus had really invented gunpowder, then it is very improbable that the inhabitants of Mozambique would have been so much alarmed by the report of guns as they were when Vasco de Gama came to their shores in 1497. For at this time these parts were in close trading relations with

India, and the whole eastern coast of Africa, from Madagascar to Aden, was populated by Malays. This is proved by the occurrence of "ficus religiosa," the sacred tree, the home of which is India, but which was planted by the Buddhists in every spot to which they brought their religion; and also by the Malay words which still exist in the language of the inhabitants of East Africa, as Livingstone has shown. It is also said that Zamonico, King of Calcutta, first learnt from two European slaves in 1501 about the making of guns.

It is equally hard to believe that the Arabians knew of gunpowder as a propelling agent before the year 1313. Reinaud and Favé thought they had found the proof of it in an Arabian manuscript in the St. Petersburg Library, from which they published the passage in question in the 'Journal Asiatique,' vol. xiv., 4th series, p. 310. It says, according to a correct translation by Professor Fleischer: "Description of the mixture which you put into the Medfaa: normal proportions of same—

10	drachms	of	saltpetre,
2	,,	charcoal,	
1½	,,	sulphur.	

This mixture is crushed to a fine powder, and with it one-third of the Medfaa is filled, but not more, else it bursts (*i. e.* the Medfaa). To it by the turner a (second) Medfaa is made from wood to the dimensions of the width of the muzzle of the (first) Medfaa; drive it (the second) in with a hard blow, put on the ball (bondoc) or the bolt, and apply fire to the quick-match. Give the (second) Medfaa the right measure until under the hole (*i. e.* the wooden plug driven through the muzzle shall reach just under the touch-hole); if it goes lower down it is faulty, and knocks the shooter on the chest. Take good heed of this."

A second passage of the same manuscript, which Reinaud cites, was evidently misunderstood by him, because both in his own and in a translation made by Fleischer gunpowder is not mentioned by a single word.

The high value attributed to this manuscript caused me, in spite of Fleischer's recognized authority, to ask those two well-known Orientalists—Professor David Henry Müller of Vienna, and Professor Vámbéry of Budapest—to give me their opinions in the matter. Although Madfa (more correctly Midfa) means in fact now-a-days gun or artillery, yet the fundamental meaning of

it is "repulsive" or "defensive," and in a larger sense it can be taken to mean defensive weapon. It cannot be supposed from this that a gun is meant, because, according to the description, this is an ordinary fire-weapon, which here in its rudiments consists of a tube with a touch-hole. The word "bondoc" (more correctly "bunduk")—which firstly signified hazel-nut, and has only much later been used for ball, and from which is derived the Turkish word for hazel-nut, "Funduk"—might lead one to suppose that the ball placed on the second medfaa had the size of a hazel-nut; but such a conclusion is always risky.

Unfortunately, with this manuscript the date—the most important essential of all—is missing. Reinaud and Favé can only say that from the whole treatment and the very rudimentary drawings they conclude that this manuscript dates from the first years of the fourteenth century, but they themselves add that it is only a very vague supposition. In deciding this matter, it is just the first half of the fourteenth century that is of importance, and an error of ten years is so weighty that one cannot accept the mere guessing of a date even if there were safer grounds than the style of writing and drawing to go upon. How can it indeed agree with the fact that Vassaf in 1313 mentions neither powder nor guns? It is also noteworthy that in 1472 the great Ussam-Cassan of Persia sent envoys to Italy in order to ask for ammunition, bombardæ, and artillerists; that later on, Ismael Sofi of Persia made a similar request to the Senate of Venice; that in 1479, in the war on the Euphrates, the Persians had no artillery, but the Turks had 15,000 persons solely for the management of theirs; and again that Mimodaj tells us that the Persians did not know how to make guns in the year 1514, and also that they had no material from which to make them.

Much greater is the fight about the invention of gunpowder in the Occident. One is accustomed to hear of the names of Marcus Graecus, Albertus Magnus, Roger Bacon, and Berthold Schwarz (in many variations) as its inventor, and it may be that they made the same invention simultaneously, as was the case with oxygen, and later on with gun-cotton.

Marcus Graecus in his 'Liber ignium ad comburendos hostes,' on page 6, makes these remarks—

"Secundus modus ignis volatilis hoc modo conficitur. Re. Acc. li. I sulfuris vivi; li II carbonum tilliae (vel cillie) vel salicis; VI li salis petrosi, quae tria subtilissime terantur in lapide marmoreo. Postea pulverem ad libitum in tunica reponatis volatili, vel tonitruum facientem. Nota, tunica ad

volandum debet esse gracilis et longa, et cum praedicto pulvere optime conculcato repleta. Tunica vero tonitruum faciens debet esse brevis et grossa, et praedicto pulvere semi plena, et ab utraque parte fortissime filo ferreo bene ligata. Nota, quod in qualibet tunica parvum foramen faciendum est, ut tenta imposita accendatur, quae tenta in extremitatibus sit gracilis, in media vero lata et praedicto pulvere repleta. Nota, quod ad volandum tunica plicaturas ad libitum habere potest; tonitruum vero faciens, quam plurimas plicaturas. Nota, quod duplex poteris facere tonitruum atque duplex volatile instrumentum: videlicet tunicam includendo. Nota, quod sal petrosum est minera terrae, et reperitur in scrophulis contra lapides. Haec terra dissolvitur in aqua bulliente, poster depurata et destillata per filtrum, et permittatur per diem et noctem integram decoqui, et invenies in fundo laminas salis conielatas crystallinas."

The following is a literal translation: "Second Method. The flying fire is made as follows:—Prescription: Take 1 lb. of live sulphur, 2 lbs. of lime or willow charcoal, 6 lbs. of saltpetre, which three are crushed together in a marble mortar. Afterwards add the powder at will into a flying-tube, or into one making thunder. Note.—The flying-tube must be thin and long, and filled with the above well-pounded powder. On the other hand, the tube making thunder must be short and stout, and with the said powder half filled and well tied on both sides with a very strong iron wire. Note, that in each of these tubes a small hole is to be made so that the match you insert can be ignited, which match should be thin at the ends but thick in the middle, and filled with the said powder. Note, that the flying-tube can have bends at will, but that making thunder only some bends. Note, that you can make double the thunder and flying instrument by enclosing the tube. Note, that saltpetre is an earthy mineral, and is found in efflorescences on stones. This earth is dissolved in boiling water, then purified and distilled through a filter and allowed to evaporate a whole day and a whole night, and you will find on the bottom hardened crystalline flakes of the salt."

The powder mixture here prescribed ( $66\frac{2}{3}$  saltpetre,  $22\frac{2}{3}$  charcoal,  $11\frac{1}{3}$  sulphur) would be about the same as our present blasting-powder. But if we consider the way of purifying the wall-saltpetre prescribed by Marcus Graecus (the Arabians did not use ashes for refining saltpetre before the thirteenth century), then we shall find that the saltpetre must have contained considerable quantities of impurities which would necessarily have made the powder containing it quite unsuitable for charging guns. Thus, not only can there be no question of gunpowder in

the present sense of the word, but according to the text it was not thought of as a means of shooting. The "tunica ad volandum" is merely a very imperfect rocket, which could only act in consequence of bad powder. The "tunica tonitruum faciens" is the cracker of the present day, and exploded because it was only half-filled, and the gases being confined by the well-tied case, gradually developed until the case burst with a report.

Therefore, Marcus Graecus' invention cannot be taken as gunpowder in the modern sense, but only as a forerunner of it. This is evident also from the fact that all his prescriptions about burning mixtures have the sole object of spreading terror and fire in the enemy's camp, as is also indicated by the title of the pamphlet, 'Book of the Fires to Burn the Enemies.' In addition to this, the words "ignis volatilis," which appear here and there in other writers, must not be taken to mean a propelling fire, but one which moves whilst burning. These mixtures also could not be propelling fires, because, as Marcus Graecus prescribed, they had to be worked only very gently in a marble mortar, whereby an intimate mixture could not be obtained.

Under these circumstances, it is idle to determine when Marcus Graecus' book was written, although there has been much quarrelling about the date. If the contents of the pamphlet are considered, it will be seen that Marcus Graecus used Arabian sources for his discourse, because he borrows from the Arabian certain words like "alkitran" (tar), "zambak" (white lily), "alambic" (still). It is of little significance whether Marcus Graecus wrote long before the end of the thirteenth century, but it could not have been before the year 1225, because in this year the Arabians could not yet have used saltpetre in their fire mixtures, and it could also not have been much later, because Albertus Magnus, who, according to Martin Crusius, died in 1280, used Marcus Graecus' discourse.

Albertus Magnus says in his work, 'De mirabilibus mundi'—

"Ignis volans : accipe libram unam sulphuris, libras duas carbonum salicis, libras sex salis petrosi : quae tria subtilissime terantur in lapide marmoreo, postea aliquid posterius ad libitum in tunica de papyro volanti vel tonitruum faciente ponatur. Tunica ad volandum debet esse longa, gracilis pulvere illo optime plena, ad faciendum vero tonitruum brevis, grossa et semiplena."

The beginning of this passage coincides with the above-mentioned one of Marcus Graecus. The rest has been condensed

by Albertus Magnus, in order, it would seem, to obtain the credit of originality, and thus the instructions for making the "tunica tonitruum faciens" have been quite muddled. The information about Greek-fire, the word "alambic," and many other things show positively that Albertus Magnus was well acquainted with the 'Liber ignium ad comburendos hostes.'

In England Roger Bacon (who died in the year 1284) is by many considered to be the inventor of gunpowder. In his discourse, 'Epistolae fratris Rogerii Bachonis, de potestate artis et naturae,' Paris 1542 and Hamburg 1618, he says—

"Nam soni velut tonitruum possunt fieri in aëre; immo majori horrore, quam illa quae fiunt per naturam, nam modica materia adaptata, ad quantitatem unius pollicis, sonum facit horribilem et coruscationem ostendit vehementem et hoc sit multis modis; quibus civitas, aut exercitus destruatur ad modum artificii Gedeonis, qui lagunculis fractis et lampadibus, igne saliente cum fragore ineffabili Madianitarum destruxit exercitum cum trecentis hominibus."

A similar passage occurs in Roger Bacon's 'Opus Majus.' Of course neither proves anything, because such extravagant expressions are also to be found about the Greek-fire. A chief argument is based upon a passage of the eleventh chapter, "De eodem" (*i. e.* "De modo faciendi ovum philosophorum"), of the pamphlet printed at Hamburg in 1618, which runs as follows—

"Sed tamen salis petrae luru vopo vir can utri et sulphuris; et sic facies tonitruum et coruscationem, si scias artificium. Videas tamen utrum loquar in aenigmate vel secundum veritatem."

The anagram, "Luru vopo vir can utri," is said to contain the Latin expression for charcoal-powder, but hitherto all attempts at deciphering it have been in vain.

In order to solve the mystery, some have assumed that the anagram should read thus: "Luru mope can ubre," which, in fact, would give "carbonum pulvere"; but with the exception of Kopp's 'History of Chemistry,' and Hoppe's 'Contributions to the History of Inventions,' I have been unable to find any proof that the anagram ever occurs in this form. I have therefore endeavoured to go back to the original sources, the Hamburg edition being a reprint of some 300 years later only.

The Library of the British Museum possesses an old collective manuscript (Sloane MS. 2156), which contains a part corresponding exactly with the Paris and Hamburg editions, but it has no headings to the chapters. The similarity is, as I have said, quite exact with the exception of the anagram. This is there



written: "Sed tamen salpêtre Kb Ka x hopospcadikis et sulphuris 5."

Among the many Bacon MSS. in the possession of the Bodleian Library at Oxford—of which probably none are from Bacon's own hand—there is also a collective volume (Digby 164), probably written in the thirteenth century, which contains a section entitled "Ex lib. Rogerii Baconis de Arte et natura." This book contains the first six chapters only, and is exactly similar to the Hamburg reprint. It ends with "Aliquibus hujus utar modis," whereupon follows a benediction. There is nothing whatsoever in it about the "philosophical egg," neither does it contain the anagrammatic sentence, and although I took the trouble of looking through all the other Bacon manuscripts, I could find no mention of them at all.

It is believed that the Oxford manuscript is the older of the two, and it may well be so, since Bacon lectured at Oxford, and additions are of necessity of a later date. In whatever light one looks at them, no value can be attached to these manuscripts, of which none are original. It seems that the passages in question are part of enlargements and additions, such as were often made to alchemistic works, accordingly as one understood the matter.

Even if we were to assume, without reason for doing so, that this anagrammatic sentence existed in Roger Bacon's original work, then he can still only have thought of an instrument producing noise and fire. Were it otherwise, he would certainly have spoken more definitely about it, in view of the extraordinary possibilities opened by such an instrument of war, and not merely have made a passing allusion to it in a chapter about a "philosophical egg."

Of much more importance is the name of Berthold Schwarz, whom the writers of the fifteenth and sixteenth centuries commonly regarded as the inventor of guns. They were not, however, so much in agreement about the date of the invention. The year 1380 is most frequently given. Flavius Blondus, of Forli (who died in 1463), says: "The pieces are a kind of weapon first used by the Venetians, with the aid of the Germans, when fighting the Genoese near Chioza," and gives 1380 as the date; so also do Æneas Sylvius, Baptista Saccus (Platina), Anton Sabellicus, Polydor Vergil, and numberless others in the fifteenth century. It is also given by Francis Irenicus, Jacob Wimpfeling, and by Johann Aventin, who wrote as follows ('Annal. Boiorum,' lvii): "You must also know that at this time lived Berchtold,

who was famous for his new invention. He was a German by birth, a Franciscan by position, a philosopher versed in magic and alchemy—in two deceitful arts, if they can be called arts at all, and not toys of foolish people. He invented the metal guns, whereby one shoots iron and stone balls and knocks down men, beasts, mounds, walls, castles, and camps as by lightning and thunder." The date is also given by Philipp Melanchthon, Hulderich Mutius, and many other writers in the sixteenth century, each of whom copied from one another. On the other hand, Achilles Gassarus names the year 1354, Crusius 1390, Alexander Scultetus 1393. The tale of a basilisk by Felix Malleolus (who died in 1456) is without significance, because he says "the gun has been invented within 200 years only."

The statements as to the place where the invention was made are also contradictory. Most writers name Freiburg in Breisgau, whilst Cornazzani speaks of Cologne, Joachim Becher and Cornelius Kempe of Mayence, Hulderich Mutius and Knipschild of Nuremberg, Athanasius Kircher of Goslar, John Lange of Weraw (?) in Bohemia, etc. It may also be mentioned that others ascribe the invention to Peter Lips, a certain Altiral from Prague, a Jew Typsiles of Augsburg, a Silesian monk Severinus, etc.

If we bear in mind that nearly all the writers, and certainly all the older ones mentioned, speak of the invention of "guns, pieces, and rifles," and if we search for authenticated records, then we shall find that the guns were known before the year 1380. Petrarca, writing about the year 1357, says "this plague is as common as any other weapon." Johann Rothe ('Thuringian Chronicles'), in his account of the siege of Einbeck by Frederick, Margrave of Meissen, against Albert, Duke of Brunswick, states that "Der marggrafe liess in Werg machin / die man zeu deme Slosse tribin solde / unde do hatte der eyne, Bli-Buchsin off deme Slosse / unde schoz darmode yn das Werg / diz waz dy erste Buchse / dy yn dessin Land in vernomme wart." ("The Margrave had an instrument made, which should be driven into the castle, but he had a lead gun in the castle and shot with it into the instrument. This was the first gun which was heard in this country.") It is reported that Master Senger, of Nuremberg, sold powder as early as 1360, and in the same year the town-hall of Luebeck was set on fire by the imprudence of those "qui pulveres pro bombardis parabant" (who made powder for the guns). Peter Divaeus records the purchase of twelve pieces of "Donder Bussen" (thunder-guns) in the year 1356 by the citizens

of Louvain. A French Mint Regulation of 1354, which was discovered in the Paris National Library, says—

“Le dix-septiesme may mil trois cens cinquante quatre, le dit seigneur Roy, estant acertené de l'invention de faire artillerie trouvée en Allemagne par un moine nommé Bertholde Schwartz ordonna au généraux des monnoies faire diligence d'entendre quelles quantités de cuivre estoient au dit royaume de France, tant pour adviser des moyens d'iceux faire Artillerie que semblent pour empescher la vente d'iceux à estrangers et transport hors le royaume.”

(“The seventeenth of May 1354, after having satisfied himself of the invention of making artillery, made in Germany by a monk, named Berthold Schwartz, has the said lord and king given orders to the generals of the Mint to inquire diligently what quantities of copper there are in the said kingdom of France, both in order to indicate means how to make this artillery and to prevent its sale to foreigners, and its exportation beyond the kingdom.”)

The English already had guns at the time of the battle of Cressy (August 26, 1346). This is proved by an account of the wardrobe of Edward III. from December 25, 1344, to October 18, 1347, which is mentioned by Joseph Hunter in the ‘Archæologia,’ 1847, vol. xxxii. In this, Thomas de Roldeston, Clerk of the King's Private Wardrobe in the Tower of London, accounts as follows: “Eidem Thomae super facturam pulveris per ingeniis et emendatione diversarum armaturaram xl sol.” (“To the same Thomas for the manufacture of powder for guns and repairing various arms, 40 shillings.”) I have also found an account,<sup>1</sup> delivered by John Cok, Clerk of the King's Great Wardrobe, for the period between December 22, 1345, and January 31, 1349, in which there are the following items: “Et eidem Thomae de Roldeston per manus Willielmi de Stanes ad opus ipsius Regis pro gunnis suis  $\text{ĪXXII}$  lib. sal petrae et  $\text{DCCCIIIIVI}$  lib sulphur vivi per breve Regis datum x. die Maii dicto anno xx°.” (“And the same Thomas de Roldeston through William of Stanes for the King's work for his guns 912 lbs. of saltpetre and 886 lbs. quick sulphur. By order of the King, dated May 10 of the said 20th year of his reign, *i. e.* 1346.”) On November 25, 1346, and again on September 21, 1347, the King ordered that all saltpetre and sulphur in the country should be bought. He received in all on the first lot 750 lbs. of saltpetre and 310 lbs. of sulphur, and on the second 2021 lbs. of saltpetre and 466 lbs. of sulphur. We also learn the interesting fact that he paid

<sup>1</sup> Public Record Office, London, L.T.R. Enrolled Wardrobe Account, No. 4.

eightpence a pound for saltpetre and eightpence a pound for sulphur, but it must be remembered that the value of money was then certainly ten times larger than it is to-day.

It appears probable that the English learnt the use of guns when fighting the French, because in the Chamber of Accounts in Paris there is an account of the War Commissary, Barthelemy du Drach, from the year 1339. It says: "Au Henry de Faumechon pour avoir poudres et autres choses nécessaires aux canons qui étoient devant Puy-Guilleme." There is also a receipt dated July 2, 1338, given by Guillaume du Moulin to Thomas Fouques for saltpetre and sulphur to make powder for guns.

According to Lenz, there is preserved amongst the archives of the town of Tournay a record that Peter of Brugge, in the year 1346, shot from a gun with powder and lead on to one of the town gates by order of the magistrate of Tournay, and that he not only made a hole, but also killed a man walking behind the gate. He was acquitted because he and the man were not enemies, and because he acted by order of the magistrate.

According to Stanislaus Sarmiczky, the Liththavian prince Gedimin was shot in 1329 by a soldier with a gun, "which had then only been invented in Germany."

Libri reports in the twenty-third volume of the 'Riformagioni di Firenze' that, on the 11th January, 1326, brass guns and wrought-iron balls were made at Florence.

According to the Metz Chronicle (Huguenin, 1838) seven town councillors inspected the town walls in the year 1324 in order to determine where fire-guns could be placed. Finally, P. A. Lenz records in the 'Nouvelles Archives Historiques, Philosophiques, et Littéraires,' Ghent 1840, p. 601, that in a manuscript chronicle, a kind of administrative year-book of the town of Ghent, which commenced in the year 1300, and continued year by year until the fifteenth century, he found the following remarkable passage—

"1313. Item in dit jaer was aldereerst ghevonden in Duutschlandt het ghebruuck der bussen van eenen mueninck." ("1313. In this year was first invented in Germany the use of guns by a monk.") Unfortunately, Mr. V. Van der Haeghen, the librarian of the town of Ghent, tells me that this passage has been repeatedly searched for, but never found, and that there is a large number of such manuscript chronicles, none of which, however, is official.

In the years 1852 to 1861 a combination of several such

chronicles was edited by the Society of Flemish Bibliophiles under the title 'Memorieboek der stad Ghent,' and therein is noted, under the year 1393 (not 1313), the following—

"1393. In dit jaer is ghevonden het ghebruick van het buscruit in Duytslant van eenen muninck." ("1393. In this year was invented the use of gunpowder in Germany by a monk.") This would be a much later date, and would refer to the invention of gunpowder, but there is no reason to assume that Lenz, who was always very careful, should have transcribed the passage wrongly. However that may be, it must be noted that gunpowder, properly so called, must have been used somewhere between the years 1310 and 1325. Berthold Schwarz, the Franciscan monk of Freiberg, should without doubt be considered the inventor of fire-arms, but there are no proofs whatever to be found that he also invented gunpowder. Later writers assumed that he must have invented powder simultaneously with the guns, as they knew of no other inventor. This explains why a manuscript book on fire-arms of the year 1432 (No. 362 in the Freiburg University Library) contains the following fable—

"Dise Kunst haut funden ain Maister, hiesse niger Berchtoldus, und ist gewesen ain Nygermanticus, und ist och mit grosser Alchymie umgangen. Sunder, als dieselben Maister mit grossen, kostlichen und hoffichen Sachen umbgänd, mit Silber und mit Gold und mit denselben Metallen; also, dass dieselben Maister Silber und Gold von dem anddern Geschmeide kunnend schaiden, und von kostlichen Varven so si machen. Also wolt derselb Maister Berchtold ain Goldfarb brennen. Zu derselben Farb gehört Salpeter, Swebel, Bly und Ölle; und wenne er die Stuck in ain kupfferin Ding braucht, und den Hafn wol vermachtet, als man auch tun muss, und in uber das Für täte, und wenne er warm ward, so brach der Hafn gar zu vil stucken, er liess ihm och machen gantz gross kupffrin Pfannen und Hafn, und verschlug die mit ainem ysinn Nagel; und wenne der Dunst nit darvon kommen mocht, so brach der Hafn, und tätten die Stuck grossen Schaden. Also tät der vorgeannt Maister Berchtold das Bly und Öl davon und legt Kol darzu, und liess ihm ain Büchs giessen, und versucht, ob man Stain damit man werffen möcht, wann er ihm vormauls Türn zerworfen hett. Also vand er dise Kunst und bessert si etwas. Er nam darzu Salpeter und Swebel glych, und Kol etwas minder, und also ist dieselb Kunst sydmalen so gar genüert, geursucht und funden worden, dass sie an Büchsen und an Bulver vast gebessert ist worden."

"Translation.—This art has found a master, named Niger Berchtoldus, and he was a 'nygermanticus,' and has also practised largely alchemy. Since, these masters are using large, costly, and polite things, silver and gold and other metals; also that these masters can separate silver and gold from the other jewels, and very costly colours, which they make. Thus, the

same Master Berchtoldus wanted to burn a gold colour: for this colour are required saltpetre, sulphur, lead, and oil; and when he brought these pieces into a copper thing, and luted well the pot, which must be done, and put it over a fire, and when it became warm the pot broke into very many pieces. He had also made quite large copper pans and pots, and nailed them with an iron nail, and when the vapour would not come off it, then the pot broke, and the pieces did great damage. Thus the aforesaid Master Berchtoldus left off lead and oil and added charcoal, and had a gun cast for it, and tried whether stones could be thrown by it, as it formerly broke his doors. Thus he found this art, and he improved on it a little. He took saltpetre and sulphur equal parts, charcoal a little less, and thus this art has since this time been renewed, caused and invented, so that it has improved largely on guns and gunpowder."

In spite of this old Freiburg MS., according to which Berthold Schwarz left off lead and oil, replacing them by charcoal, had a gun cast, and threw stones with it, *all at the same time*, the monument erected in honour of Schwarz at Freiburg names the year 1353 as the date of his alleged invention of gunpowder, which, however, is not proved by any existing record.

It can scarcely be assumed that the gradual introduction of saltpetre into Greek-fire and the manufacture of mixtures approaching gunpowder should have been invented in Germany. It must be remembered that the Arabians and Saracens were at this time far ahead of Europeans in chemical and medical knowledge. In Europe the use of Greek-fire, fire-arrows, and in general of all weapons throwing igniting mixtures were not considered as honourable. The highly chivalrous sense of the Crusaders repudiated any other form of fighting than that of personal encounter. The clergy preached against fires as children of the devil, and one can thus understand why the Crusaders were so frightened of Greek-fire as to describe its action in most exaggerated terms, and also why in the West very few were engaged in perfecting such fires. There is fairly good cause to assume that this knowledge came from the East, the Arabians, since at this time there was a very large shipping trade done, especially by the Phœnicians and Genoese, with Germany and England, and since the Crusaders evidently gained experience to their own detriment.

We thus come to the brief conclusion *that gunpowder was gradually developed from Greek-fire, and that it was known for years before cannons and guns were thought of. The use of purer*

*materials in making it developed its propulsive power, and led to the subsequent invention of cannons and guns. The Arabians were the first to make gunpowder-like mixtures, probably about the year 1280 A.D., whilst the idea of utilizing their propulsive force—that is, the invention of guns and cannons—belongs to the monk, Berthold Schwarz, of Freiburg; the date of the latter invention being probably about 1313 A.D.*

The manufacture of gunpowder must originally have been done in stone mortars, and by hand. When the consumption became too large, as it soon did, mill-stones were used.

It is known that gunpowder-mills existed in the year 1340 at Augsburg, in 1344 at Spandau, and in 1348 at Liegnitz. In the year 1435 Harscher owned a stamp-mill at Nuremberg, and they soon spread everywhere. Thus, in the year 1692, there were already 22 powder-mills with 829 stamp-heads in France, supplying from March to October in every year 2,310,000 lbs. of gunpowder.

The first roller-mill was built in 1754 by Ferri, in Essone in France; and in the same year Karl Knutberg, in Sweden, designed a sort of incorporating-mill.

Originally the ingredients were simply finely powdered and mixed by hand. In 1525 the French powder-mills began to grain it and classify it through sieves. Between 1777 and 1778, Lavoisier made his great experiments on the deflagration of powder. At the same time Berthollet endeavoured to determine the best proportions for mixing powder, and arrived at the following—16 saltpetre, 1 sulphur, 3 charcoal (80 : 5 : 15).

Shooting weapons were not extensively used in Germany and France until after the year 1380, because the chivalrous sense and religious zeal of the time did not take kindly to them, though siege-guns were probably adopted very soon by all. Originally common stones were shot, which later on were wrapped round with sheet-iron, and about 1347 lead balls were used. In the fifteenth century cast-iron balls appeared, but they were still called stones, as can be seen from the leave-taking ordnance (Reichsabschied) of the Emperor Frederick III. in 1475.

In Russia (Litthavia) the first use of fire-arms was in the year 1389, according to the chronicle of Galizyn, as quoted by Karamsin in his history of the Russian Empire. Gunpowder is said to have been first used in Sweden in the year 1400.

Until a few years ago gunpowder remained the only propelling agent in use for arms of all kinds. It is true that Don

Barcelo in 1784, Minando in 1789, Bains in 1789, and Wurzer in 1792 tried to add other ingredients to gunpowder, and such experiments are still frequently made, but no substitute which gave satisfaction from every point of view could be found.

For modern guns the so-called brown prismatic powder has been used since 1882. It was first made in the gunpowder factory of Rottweil-Hamburg, and consists of 77 parts of saltpetre, 20 parts of charcoal made from rye-straw, and 3 parts of sulphur.

A considerable impetus to the development of explosives was given by the invention of the so-called nitro compounds. Braconnot, of Nancy, was the first to find in the year 1832 that starch, wood fibres, and similar substances would yield easily combustible substances, which he called xyloidine, when treated with concentrated nitric acid. Pelouze, in the year 1838, took up these experiments with xyloidine, and found that it ignited at 180° C., and that it exploded by strong pressure or a blow. He found that in general cotton, paper, and all vegetable substances are suitable for the manufacture of this stuff, and he recommended its use for fireworks.

Dumas also discovered a similar explosive agent called nitramidine by treating paper and cardboard with strong nitric acid. But these discoveries had no practical result, because products giving uniform effect and of sufficient stability could not be made.

In the year 1845 Schönbein of Bâle found that cotton could be converted into a highly explosive body without altering its structure by treating it with nitric acid. Schönbein kept his invention secret; and in 1846 Böttger, of Frankfort-on-the-Main, made the same discovery, independently of Schönbein. Subsequently the two discoverers united, and offered their invention to the German Union, asking for a national award. The Union made the condition that the gun-cotton should not only replace gunpowder in every direction, but that it should also have advantages over it. In the meantime, Otto of Brunswick announced in the Augsburg 'Allgemeine Zeitung,' of October 5, 1846, that he had succeeded in making an explosive having the properties of Schönbein's gun-cotton by dipping purified cotton into highly concentrated nitric acid for half-an-hour, and subsequently carefully washing and drying it. Since by this process the cotton became strongly felted, Knop, of Leipsic, and Karmarsch and Heeren, of Hanover, tried to modify this process, and found



that a mixture of nitric and sulphuric acids, which had already been used by Schönbein and Böttger, was the most advantageous for its preparation. From this time experiments were made in France, England, and Russia to introduce gun-cotton in place of gunpowder. Since no one then knew how to properly purify the gun-cotton, and as little importance was attached to the purification of the original cotton, the various experimenters were unable to make products that would keep unaltered; and in the years 1847-8 there were explosions at Vincennes, Bouchet, and Faversham. In the meantime, Captain Von Lenk succeeded in making a stable and uniformly-acting gun-cotton; and after experiments had been made from 1849 to 1852, the Austrian Government was induced to contract with Schönbein and Böttger for the cession of their invention.

In the year 1853 Von Lenk was charged with the erection of a gun-cotton factory at Hirtenberg. Special artillery for gun-cotton was introduced in Austria, and gradually gun-cotton was made use of for the purpose of guns. In time it was found that the guns were attacked by the gases of the gun-cotton, and that the high pressures developed injured the barrels. It was therefore decided to use gun-cotton only for blasting purposes, and for filling shells and torpedoes. Unfortunately, from causes that have never been explained, the magazines of Hirtenberg exploded in the years 1862 and 1865. After the second explosion the Austrian Government stopped the manufacture of gun-cotton altogether, and was opposed to the re-erection of gun-cotton works until the year 1875. In the year 1862 Von Lenk patented his process in England, and the firm of Prentice and Co. erected a factory at Stowmarket on the pattern of the Hirtenberg one. In 1865, the chemist to the War Department, Sir Frederick Abel, then Mr. Abel, found that the chief objections to the use of gun-cotton were caused by its imperfect purification, and in April of the same year he patented a process by which gun-cotton is thoroughly purified and reduced to a fine powder in beating-machines, and then pressed. The Stowmarket factory bought this patent; and although, in August 1871, a very serious explosion took place there, which was attributed to malevolence, Abel's process has been gradually introduced everywhere, and is still the one generally used at the present time.

Simultaneously with Pelouze, a young assistant of his, Ascanio Sobrero, made experiments on the nitrating of various bodies. When later on he became Professor of Chemistry at Turin, he

continued his experiments, and in the year 1846 he discovered that glycerin was a body highly suitable for nitration.<sup>1</sup> Sobrero called the product made by him pyro-glycerin, and it is interesting to know that about 200 grammes of the first nitro-glycerin made by Sobrero are still kept at the Nobel dynamite factory at Avigliana, in Italy, and are tested every year. Although Sobrero at the time pointed out the various possibilities of his "pyro-glycerin," the invention remained undeveloped for a long time, being only used in small quantities, and in very dilute alcoholic solutions, under the name of glonoïne, as a remedy for headaches.

In 1863 Alfred Nobel, a Swedish chemist, after a number of experiments, arrived at the idea of exploding pyro-glycerin by means of small gunpowder charges. Originally he introduced it as a blasting agent in a liquid state, under the name of nitro-glycerin; but it was soon found that on account of its liquid state its use in mines presented great difficulties, and that numberless accidents happened with it. After this, Nobel proceeded to dissolve nitro-glycerin in wood-naphtha, whereby it became almost inexplusive, but the wood-naphtha had to be separated before using, and this was also very troublesome. G. M. Mowbray, of Massachusetts, utilized the property possessed by nitro-glycerin of freezing easily, and being very insensitive to shocks in that state, by transporting it after being frozen in tin bottles. In this form it was used in America from the time the Hoosac tunnel was built until a few years ago. The various defects and drawbacks of liquid nitro-glycerin caused Nobel to try all sorts of bodies with which it could be mixed, to produce a non-liquid mass, and in 1866 he finally found that kieselguhr (a highly porous infusorial earth), when mixed with nitro-glycerin, gave a very plastic and still perfectly absorbent product, which could be conveniently introduced into bore-holes. Nobel gave this product the name of "dynamite." Originally dynamite had to be exploded by means of small charges of sporting powder; but in the meantime Mr. E. A. Brown, the second chemist of the English War Office, found that gun-cotton could be safely

<sup>1</sup> In most books it is stated that Sobrero invented nitro-glycerin in the Laboratory of Pelouze, but this is erroneous. The author was once specially requested by Professor Sobrero (who died in 1898) to always contradict this statement, and to emphasize the fact that the invention was made in his own laboratory when professor at Turin. He was an Italian, with strong patriotic feelings, and seems to have been specially sensitive on this point.

and surely exploded by means of fulminate of mercury, and this method of detonating was soon used for dynamite also.

The various attempts to evade Nobel's dynamite patent, and to find other bodies which had the same or a greater absorbing capacity for nitro-glycerin than kieselguhr, may be passed over.

It was again Alfred Nobel who, in 1878, made the next advance by inventing blasting gelatine. He found that di-nitro-cellulose had the peculiar property of forming with nitro-glycerin a tough, horny, jelly-like mass, from which the nitro-glycerin did not separate out even under water, and which had a much stronger effect than dynamite. His chemists, Siersch and Roth, together with Captain Hess, perfected blasting gelatine to such an extent that it became a material suitable for military blasting, for which purpose it was used in several armies until a few years ago.

Picric acid has been known for more than 120 years. In 1771 Woulffe noticed its power of dyeing silk yellow. Its relation to phenol was first observed by Lorrent in the year 1842. In 1867 Borlinetto recommended a mixture of picric acid, sodium nitrate, and potassium chromate as a blasting powder; while, at the same time, potassium picrate was used in North America and in England as a charge for bombs. Designolle also described a powder, the base of which was potassium picrate, and Brugère one with ammonium picrate.

In 1887 Eugène Turpin, of Paris, patented the use of picric acid in a compressed and molten state, and also in combination with collodion for filling shells, and soon after the French Government introduced it under the name of "Mélinite." The method of detonating molten picric acid by a primer of dried gun-cotton was discovered in Italy in the same year; and a year after a blasting material called "Ecrasite" was introduced into the Austrian army, which was made by Nobel's dynamite factory at Pressburg from ammonium-tri-nitro-cresol.

A long time ago, experiments were made to produce gun-powder from nitro-compounds.

In 1864 E. Schultze, of Potsdam (a captain of artillery), made a gunpowder from nitrated wood, which later on was manufactured on a large scale at Volkmann's factory at Pressburg, and in this country is made chiefly by the Schultze Company. This powder is still extensively used in England, but only for sporting purposes. In 1882 Mr. Walter F. Reid made a sporting powder from gun-cotton by granulating it and dipping it in ether-alcohol, and he

called it "E. C." powder. Later on Messrs. Judson and Borland made a similar powder from gun-cotton and camphor, which they called "J. B." powder. About the same time Wolff and Co., of Walsrode, made cubes of gun-cotton for filling shells, which they dipped in acetic ether, to give them a waterproof coating. These were the initial stages of a complete revolution in gunpowder manufacture, since in 1886 Vieille, the celebrated chemist of the French gunpowder works, devised a means of making a smokeless gunpowder (that is, a powder which develops little or no smoke on combustion) from gun-cotton dissolved in sulphuric ether mixed with picric acid. Shortly afterwards the English and German Governments were in possession of cartridges made of this powder, and made experiments on their part. The chief inducement to obtain such a powder was their intention of using small-calibre rifles which would allow the soldier to carry a maximum of cartridges, and at the same time give a higher pressure per square inch on the projectile to balance the reduced area of the space. Professor Hebler, of Zurich, and Major Rubin, of the Swiss army, were chiefly responsible for the introduction of small-calibre rifles, and as a proof of the rapid development of smokeless powders, it may be mentioned that as late as the year 1885 the author was consulted by Professor Hebler as to whether it would be possible to make small cylinders of compressed gun-cotton for use as a charge for cartridges in small-calibre rifles in the place of gunpowder.

Whilst France and Germany were endeavouring to perfect their gun-cotton powders, Alfred Nobel formed the idea of making the rate of combustion of his blasting gelatine sufficiently slow by increasing the percentage of gun-cotton so as to enable it to be used as a gunpowder. This led to his patenting, in 1888, a smokeless powder, which he called "Ballistite," and which he succeeded in getting introduced into the Italian army. Sir Frederick Abel and Professor James Dewar (members of the English Committee on Explosives) invented a smokeless powder consisting of a combination of the highest nitrated cellulose with nitroglycerin by dissolving both in acetone. This was introduced under the name of "Cordite," as the English service powder. Simultaneously, every Government was making experiments in the manufacture of smokeless powders, and most of them introduced gun-cotton powders with greater or smaller variations.

Thus during the last six years, that is to say, since 1888, almost every European army has been provided with a smokeless

powder. The old black powder has been rapidly and completely superseded, and although there are objections to smokeless powders, all of which have still some defects, there is no doubt that the days of black powder are numbered, if not already over. And thus what has for centuries with unaltered components been considered a firm rock in the sea, has, as it were, been washed away over-night, and now almost belongs to history alone.

## CHAPTER I

### PRIME MATERIALS AND INGREDIENTS OF EXPLOSIVES

#### 1. POTASSIUM NITRATE

##### I. CRUDE SALTPETRE

THE name "nitrum" with the ancient Greeks and Romans originally signified carbonate of soda. Later on saltpetre was held to be a species of nitrum, since it also effloresced. The substance we now call saltpetre is first mentioned by Geber in the eighth century, as "sal petrae" or "sal petrosum." Raymond Lullius, in the thirteenth century, alludes to "sal nitri," and it is only after the sixteenth century that saltpetre is called "nitrum."

According to Ržiha, Archbishop Günther, of Magdeburg, in 1439 made the manufacture of wall-saltpetre a monopoly; and in 1520 Gustave I. of Sweden ordered that the earth of cemeteries should be lixivated, in order to extract saltpetre from it. In 1546 Agricola described the boiling of saltpetre ("halinitrum"). In 1561 there were 22 saltpetre boilers in Sweden. In 1602 it had been determined how much saltpetre would be obtained from a certain quantity of earth. In 1605 an ordinance of Henry VI. of France was issued relating to the making and refining of saltpetre. In 1642 a tax was imposed in Sweden which had to be paid in saltpetre; and in 1755 a prize of 4000 livres (which was subsequently doubled) was offered in France for the best memorandum on the manufacture of saltpetre. Lowitz and also Gondolin rendered good service in 1788 by improving the methods of purifying saltpetre, the latter having introduced refining in large quantities.

Saltpetre is formed in nature by the decay of nitrogenous substances in the presence of air, moisture, and alkaline earths or alkalis. By this decay ammonia is formed, which absorbs oxygen from the air, whereby its nitrogen is oxidized to nitric acid. This in turn is taken up by the alkalis present, with which it forms

nitrates. It follows from the nature of the processes of decay that warm climates are more suitable than cold ones for the natural or artificial formation of saltpetre, because higher temperatures considerably facilitate decay.

The formation of crusts of saltpetre on the soil in various countries, especially in East India (in the province of Tirhût, in Bengal), and also in Hungary, Persia, Egypt, etc., is caused by the moisture of the air or rain soaking into the soil, and by the efflorescence of nitric salts in dry weather through the capillary action of the soil.

This efflorescence is collected, extracted, and evaporated by natural or artificial heat. The liquor is purified either by frequent raking over in heaps, whereby the potassium silicates are decomposed and transformed by nitrates of lime, by fermentation, or wood ashes are added, whose potassium salts act in the same manner.

An analysis of Bengal saltpetre made by Tatlock gave the following result :—

Potassium nitrate	...	...	96.51 per cent.
Potassium sulphate	...	...	0.89 "
Potassium chloride	...	...	0.84 "
Sodium chloride	...	...	0.20 "
Insoluble	...	...	0.21 "
Water	...	...	1.35 "
			100.00

Formerly saltpetre was frequently made artificially in Sweden, France, Hungary, Switzerland, etc., in the so-called saltpetre plantations. In these, marl, builders' rubbish, etc., were mixed with stable dung and other nitrogenous substances, sprinkled frequently with urine, spread out, and allowed to decay and evaporate until sufficient quantities of nitric salts were formed. The saltpetre earth so obtained was extracted in vats connected in series in such a manner that the liquor continually increased in strength. The salts in the liquor were then converted into potassium nitrate by the addition of potash, whilst carbonate of lime and magnesia separated out at the same time.

In whichever way the saltpetre earth is obtained, it always contains, in addition to potassium nitrate, some potassium chloride, sodium chloride, and many other impurities. On evaporating the liquor the chlorates sink to the bottom, the more readily as the concentration increases, since the salts mentioned are soluble in hot water in widely differing quantities. On the other hand,

potassium nitrate is soluble with difficulty in cold water; and if therefore, the evaporated liquor is allowed to cool, the saltpetre crystallizes out. These properties are utilized in the evaporation of the saltpetre liquor. The apparatus illustrated in Fig. 1 is used for this purpose. (A) is a copper boiler, to which a pre-heater (B) is sometimes added, and which is heated by the fire (a, r). The flame passes through the flues (c), under the pre-heater (B), and then into the chimney, the draught being regulated by a damper in the usual manner. A pan (m) made of perforated sheet copper is suspended by a chain (h), passing over a pulley (o), and a balance weight. This pan is kept suspended about an

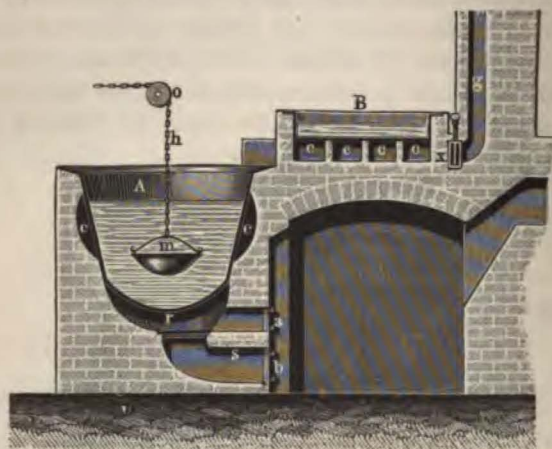

FIG. 1.—One-50th full size.

inch above the bottom of the boiler, and in it the chlorates are deposited by the current of the boiling liquor, and caking is thus prevented. From time to time the pan is drawn up, and the separated materials are emptied on to a tray near the boiler, the mother-liquor from which runs back into the boiler. As soon as a salt coating appears on the surface of the liquor and a drop of it placed on a plate or a piece of sheet metal solidifies at once, the liquor has attained a sufficient concentration. The skimmer is then taken away, the fire drawn, and the liquor left to settle. It is then transferred into copper crystallizing pans, in which the crude saltpetre crystallizes out over-night. This is put on to a draining-shelf, or into vessels with false bottoms, in order to get rid of any mother-liquor which is still adhering to the saltpetre.

The materials separated out consist chiefly of sodium chloride,



but they contain also a good deal of saltpetre. To recover this they are put into close-meshed wickerwork baskets, which are suspended in a boiler filled with boiling water. More and more of the separated materials are added, because the water is soon saturated with salt, but can still dissolve saltpetre. When it is also saturated with the latter, the liquor and also the mother-liquor coming from the crystallizing pans are added to the next charge, the salt being sold. All the crude saltpetre, from whatever source it is obtained, still contains between 15 and 25 per cent. of impurities in the shape of foreign salts, organic matter, etc., and it has therefore to be refined again. Most of the crude saltpetre is imported from Eastern India, where the efflorescences of saltpetre are collected by a special caste, the Sorawallahs.

## II. REFINING OF CRUDE SALTPETRE.

### (a) *Examining the Crude Saltpetre.*

1. **The French Method.**—This was devised by Bottée and Riffault in the year 1797, and is still in use.

The crude saltpetre supplied to the Government Gunpowder Works is generally increased in strength by crushing the crystals and washing them with water or mother-liquors until they contain between 90 and 94 per cent. of potassium nitrate.

In examining crude saltpetre, two samples of 400 grammes each are drawn, and a litre of water, which has been previously saturated with saltpetre at a temperature of  $12.5^{\circ}$  C., is poured over each, the mixture is stirred for ten minutes, allowed to settle for a moment, and the liquid on the top poured off on to a filter. A second washing is made with 250 cubic centimetres of water saturated with saltpetre, and the whole is poured on to the filter. The solution of saltpetre must be completely saturated, and in order to keep it in this state the work must be carried out in a place where the temperature remains constant, so that none of the saltpetre contained in the sample is dissolved, and none precipitated from the washing solution.

When all the liquid has run through, the filter is carefully laid on a sheet of blotting-paper, under which cuttings of filters, whiting, lime, ashes, or similar absorbing substances are spread in a flat vessel. After twenty-four hours the saltpetre can be easily scratched off the paper. It is then placed on a sand-bath, or dried over a small fire. The dried saltpetre is weighed, and a

fourth of the difference between the present weight and the 400 grammes originally taken gives the percentage of impurities in the crude saltpetre. To this 2 per cent. is added to allow for insoluble materials and the saltpetre which might have been left by the saturated solution of saltpetre. The necessity for this addition of 2 per cent. has been arrived at by experience.

This method has several sources of considerable error. Apart from the evaporation of water from the saturated solution of saltpetre and the possibility of the temperature altering, whereby the saturation point of the solution is altered, gypsum and other insoluble substances, such as alumina and oxide of iron, which exist in the crude saltpetre, also remain in the residue and cause the method to give too high a percentage of pure saltpetre.

The presence of much potassium chloride in the saltpetre causes a reduction of temperature on dissolving the latter, whereby a separation of saltpetre from the saturated solution takes place. The reverse is the case if too much sodium chloride be present, because this causes the solution of a considerable quantity of saltpetre, as proved by Lavoisier.

In consideration of this latter point, attempts have been made to construct a correcting table, but no uniformity has been arrived at. For these reasons, to say nothing of the twenty-four hours required for this method of examination, it has not been used in any other country than France.

**2. Spandau Method.**—The method used in Spandau for the examination of crude saltpetre is the following:—

*Preliminary Examination.*—This is always performed if there is any doubt of the major part of the material to be examined consisting of saltpetre only. A crystal of sulphate of iron is dissolved in distilled water in a beaker, and on to it about half as much concentrated sulphuric acid is poured, and as soon as the liquid, which becomes heated by the addition of the sulphuric acid, has cooled down, a few drops of the saltpetre solution are added. If a reddish or a brown coloration is produced, the sample contains a nitrate.

In order to determine whether the sample is saltpetre, potassium is tested for by adding a few drops of perchloric acid to another part of the dissolved sample. If a white granular precipitate is formed, the sample contains potassium.

If an approximate idea of the proportions be desired, then some of the crude saltpetre solution is put on to a watch-glass, placed over sulphuric acid, and allowed to crystallize. The

characteristic shape of the crystals formed gives the required information when compared with trial solutions of the most frequently-occurring compositions of crude saltpetre. They are made with pure ingredients beforehand and crystallized for comparison.

*Qualitative Examination.*—In this acids and chlorine are to be considered on the one hand, and bases on the other.

In order to detect the former, a concentrated solution of saltpetre is prepared, and hydrochloric acid added to a portion of it. If it froths up, carbonic salts are present, in which case a little more hydrochloric acid is added, and the solution boiled until all carbonic acid is driven off. If on adding barium chloride the solution becomes turbid or a white precipitate is formed, then sulphates are present.

The other part of the solution is acidified by means of nitric acid free from chlorine, and nitrate of silver is dropped into it. The sample contains more or less chlorides according to whether it becomes turbid, or a white flocculent precipitate is formed.

In order to determine the bases, ammonia is added to a further trial solution. If magnesia is present it becomes turbid, or a precipitate may be formed. If aluminium or iron salts are present, the respective hydrates are precipitated. To a fourth portion a few drops of potassium oxalate are added. If a turbidity or a precipitate is formed immediately or after a short interval, then the saltpetre contains lime.

To determine whether the sample contains sodium, a small porcelain dish is filled to about two-thirds with crude saltpetre, and alcohol is poured over it and ignited. The flame will have the characteristic yellow colour even with very small quantities of sodium. In order to make quite sure, some alcohol and pure saltpetre are always burnt simultaneously in a second porcelain dish.

*Quantitative Examination.*—Suitable samples must be taken from as many different places as possible of the crude saltpetre to be examined, then carefully mixed by hand in a large porcelain dish, and exactly 320 grammes weighed out. The weighed portion is then put into a porcelain dish about 0.156 metre wide and between 0.078 and 0.104 metre deep. Double the quantity of distilled water is then poured over it. In order to dissolve the saltpetre more rapidly, it is heated, and the solution, which is kept boiling for some time, is filtered through a weighed filter (A), which has been previously dried at 100° C.

In order to avoid the crystallization of saltpetre on the filter, the glass funnel is placed into a jacketed funnel made

of sheet-zinc, through which hot water is circulated by means of a branch tube on the side. When everything has passed through, the filter is washed, first with hot and then with cold water, until a drop of the washing-water, when evaporated on a sheet of platinum, leaves no residue. The filter is then dried at  $100^{\circ}$  C., and the filtrate boiled down to about one-third of its volume. The vessel containing the concentrated solution is put into a larger one containing cold water, to which saltpetre residue is added, in order to keep the temperature under  $0^{\circ}$  if possible. Whilst the solution is cooling down, it is frequently stirred with a glass rod, in order to prevent the formation of large crystals of saltpetre.

When no further alterations of temperature take place, the whole is filtered through a filter (B) which has been weighed and dried at  $100^{\circ}$  C., and the saltpetre remaining on it washed until a portion of the washing-water, when nitrate of silver is added to it, does not become turbid. The filtrate and washing-water are boiled down to about one-third of their volume and again cooled down and filtered as described above. The saltpetre which separates out is placed on a weighed filter (C), and the liquid draining from it again concentrated to one-third its volume, the saltpetre obtained on cooling being placed on a weighed filter (D). The liquid remaining is then evaporated to dryness in a water bath, re-melted, and weighed after cooling. All filters are dried at  $100^{\circ}$  C., the saltpetre taken from them being re-melted and weighed after cooling.

The results of the various weighings are as follows:—

(a) The weight of the filter (A) after deducting the tare gives the organic and insoluble matter contained in the saltpetre, splinters of packing material, sand, earth, lime, etc.

(b) The sum of weights of the three filters (B, C, D), after deducting the tare and the weight of the melted saltpetre, gives the weight of the pure saltpetre obtained in the first instance.

(c) The weight of the residue of the liquid evaporated in the last instance gives the weight of the remaining salt in the whole solution.

(d) The results of  $a + b + c$  deducted from the total weight give the moisture contained in the crude saltpetre examined.

Since the residue mentioned under *c* still contains some saltpetre, it has to be examined for potassium and nitric anhydride. For this purpose it is put into a porcelain mortar, and pounded very finely. The potassium is determined in two portions, each of 3 to 4 grammes. Cold water is poured over each of the weighed

quantities in a beaker, and about five times its weight (15 to 20 grammes) of perchloric acid added to the solution. In order to determine this, 3 to 4 grammes of potassium carbonate are dissolved in cold water, and perchloric acid added in small portions from an exactly weighed quantity of the same until no further effervescence takes place. The quantity added is found by weighing the remainder. The perchloric acid to be added to each test must be in the same proportion.

The two samples are now put on a sand-bath, and evaporated until they are nearly dry. Each sample, after cooling, has four to five times its volume of absolute alcohol poured over it, and is repeatedly stirred for two hours. The potassium perchlorate deposited is placed on a weighed and dried filter at 100° C., and washed with alcohol until a drop of the washing does not leave any residue on a sheet of platinum.

The filters are then dried at 100° C. and weighed, this operation being repeated again and again until the weight becomes constant. The average of the final weights, after deducting that of the filters, gives the weight of the potassium perchlorate formed, and therefrom the amount of potassium contained in the sample, by using for this reduction the proportion obtained by the above described test for potassium carbonate. It may be noted that 1 gramme of potassium carbonate gives on an average 1.769 grammes of dry potassium perchlorate.

In order to determine the nitric anhydride, two samples of about 6 grammes each are weighed out from the remaining salt, and each mixed in a porcelain mortar with half its weight of charcoal and three times its weight of well-dried sodium chloride. The mixture is melted in a crucible about 0.156 metre in height. When the effervescing ceases, the crucible is placed on a sand-bath, which has been previously heated as much as possible, and both are allowed to cool down. In the resulting solid mass all the nitrate will have converted into carbonate. The mass is broken up and placed into a bottle, any small residue remaining in the crucible being rinsed out into the bottle by means of hot water. The bottle is closed by a cork with two holes. Through one of these openings a thistle-funnel is put, and through the other a glass tube bent at a right angle. As soon as the bottle has attained the temperature of the room, it is weighed, together with a small glass containing concentrated hydrochloric acid. The latter is poured through the thistle-tube into the dissolved mass until all effervescing ceases. In order to drive out all carbonic

acid, the bottle is put into lukewarm water for a few minutes. After cooling, it is well dried and weighed together with the glass which contained the concentrated hydrochloric acid. The average of the loss in water of both samples gives the amount of carbonic acid. For each 21·76 parts by weight of carbon dioxide, there were 53·41 parts of nitric anhydride contained in the crude saltpetre. In 100 parts of saltpetre there are 46·59 parts of potassium and 53·41 parts of nitric anhydride. By melting with charcoal it is converted into 68·35 parts of potassium carbonate, which contain 46·59 parts of potassium and 21·76 parts of carbon dioxide.

Having in this manner determined the percentage of potassium and nitric acid in the quantities examined, the percentage of potassium and nitric anhydride in the whole of the remaining salt has then to be calculated. For each 46·59 parts of potassium and 53·41 parts of nitric anhydride there are always 100 parts of saltpetre to be taken as present in the remaining salt, and if the quantities found are added to those already found by crystallization, it will give the whole of the pure saltpetre contained in the 320 grammes of crude saltpetre.

(b) *Refining Process.*

Crude saltpetre from Eastern India is now-a-days only used in England. In Germany and most other countries, with the exception of France and Sweden, artificial saltpetre is almost exclusively used.

The process of refining is based upon the fact that saltpetre is more soluble in hot water than in cold, whereas common salt is soluble in about equal quantities both in hot and cold water.

The table given opposite shows the quantities dissolved in 100 parts of water at various temperatures.

1. **Spandau Process.**—1400 litres of water are put into a copper boiler, holding about 3000 litres, which is set in brickwork, and heated to ebullition. Then 2500 kilogrammes of crude saltpetre are gradually added in quantities of about 50 kilogrammes at a time, its solution being promoted by agitation. About 8·30 grammes of glue are dissolved in 8 litres of hot water and added to the solution of saltpetre, in order to assist the separation of impurities. The glue combines with the organic substances, forming a flocculent mass, which rises to the surface in the form of scum. As soon as this appears, the residue is ladled out from the boiler

## IN 100 PARTS OF WATER ARE SOLUBLE

SALTPETRE.		SODIUM CHLORIDE.	
Temperature in degrees C.	Parts.	Temperature in degrees C.	Parts.
0	13.3	-15	32.37
5	17.1	-10	33.49
10	21.1	-5	34.22
15	26.0	0	35.52
20	31.2	+5	35.63
25	37.3	9	35.74
30	44.5	14	35.87
35	54	25	36.13
40	64	40	36.64
45	74	60	37.25
50	86	70	37.88
55	98	80	38.22
60	111	90	38.87
65	124	100	39.61
70	139	109.7	40.30
75	155		
80	172		
85	189		
90	206		
95	226		
100	247		
105	272		
110	301		
114	326		
114.1	327.4		

and the scum removed from the surface. When the impurities cease to rise, and the liquor has been concentrated to 45° B. (90° Tw.), the boiler is covered with a large wooden cover and the stoking stopped, a small fire only being kept in the grate. After standing for about twelve hours the liquor is drawn off into a copper crystallizing pan.

There is a draw-off tap placed at the level where the bottom of the boiler begins to take a round shape in order to avoid drawing off the impurities, which may have been deposited on the bottom, when emptying the boiler. As a further precaution, the liquor is filtered before it goes into the crystallizing pans, and for this purpose a frame with two coverings of cloth is laid over the pan. In order to prevent the separation of large crystals, which would always enclose some mother-liquor, the liquid is constantly stirred with wooden rakes, by which means the crystals are obtained quite small. These are skimmed off with flat perforated copper ladles and placed in baskets

standing on boards above the crystallizing pans, where they are left until the mother-liquor adhering to the crystals has drained off completely into the pan. The saltpetre separating out in the pan during the next twenty hours is used for a subsequent refining, whilst the remaining liquor is drawn off through a channel under the floor into a cistern arranged for this purpose.

The saltpetre contained in the baskets is then placed in a copper washing-box with a wooden perforated false bottom. After having uniformly distributed the saltpetre in the washing-box, it is washed with cold water from the river Havel. The saltpetre made from sodium nitrate and potassium chloride is washed only once, which is done by pouring about 0.1 cubic metre of water from a small watering-can over the surface of the saltpetre. The washing-water collecting under the false bottom is drawn off by means of a tap, and runs through a channel under the floor into a cistern.

The washed saltpetre is put into large boxes, which are arranged in such a manner that the washing-water can drain off completely. This draining takes about twelve hours. After it is completed, the saltpetre is dried on large wood gratings covered with linen sheets. This allows the circulation of the air through and over the saltpetre to take place, which removes a large quantity of the moisture contained in it. After remaining on these frames for a few days, it is placed on copper drying-trays heated by warm air, and constantly turned over with wooden rakes, in order to eliminate the last traces of moisture. The saltpetre clogs into lumps, which have to be broken up by means of wooden mallets. When it begins to be dusty it is considered to be dry, and is then placed in wooden kegs holding 50 kilogrammes.

2. **The French Process.**—There is very little difference between this and the one used at Spandau. The crude saltpetre is placed in a flat pan and watered with washing-water coming from a previous operation, which is thus already saturated with saltpetre. It is left standing for twelve hours, after which time the saltpetre is fished out with ladles and piled on to the sides of the pan for draining. In this manner it is freed from a large part of the soluble foreign salts. It is then dissolved in as little water as possible by the aid of heat in a large copper boiler. Generally one part of water is required for three parts of saltpetre. A solution containing 1 kilogramme of glue to 30 litres of water is added for clarification. This quantity is sufficient to clarify 4000 kilogrammes of saltpetre, and is added in two



portions, the first containing 20 litres and the second 10 litres. Each time it is well stirred and a little cold water added in order to delay ebullition. The scum is continually taken off, and as soon as it ceases to form, the contents of the copper are left standing for a few hours, care being taken that the temperature does not fall low enough to allow crystallization of saltpetre to take place.

The rest of the process is nearly identical with that of Spandau.

**3. The English Process.** (Waltham Abbey.)—Fig. 2 gives a general view of the refining process used at the Waltham Abbey factory.

The boilers (A), made of copper, hold 500 gallons, and have a perforated false bottom in order to prevent caking of the saltpetre, and to allow sand and other impurities to fall through. They are charged with 25 cwt. of crude saltpetre, and the following products from previous operations: 5 cwt. of crystals from evaporated mother-liquors, 5 cwt. of crystals left in the crystallizing pans, and 280 gallons of water from washing the purified saltpetre, the latter containing about 5 cwt. of saltpetre. The total charge is therefore about 40 cwt. of saltpetre.

After about two hours' firing, the solution begins to boil, and the moment it does so it is skimmed and the false bottom drawn out. The temperature is then about 230° F., and the specific gravity 1.49. From time to time cold water is added to promote the separation of scum, the formation of which ceases after about half-an-hour. The boilers are then filled with cold water, and the liquor allowed to boil for a few minutes, after which the fire door is opened and the fire allowed to burn down.

After about two hours the temperature of the liquor falls to about 220° F., when its specific gravity is 1.53. It is then pumped by means of a hand-pump into the filters (B). These are wooden troughs with four outlet holes, which can be closed by means of plugs. Under each hole a cloth filter-bag is suspended, from which the liquor runs through a closed channel underneath into the crystallizing pans (C). These are made of wood, and are 12 feet long, 7 feet wide, and 11 inches deep. The liquor in them is about 6 inches deep, and it is kept constantly in motion by stirring with wooden rakes fitted with long handles. This promotes the formation of fine crystals of saltpetre. From time to time the crystals formed are drawn up on the side and thrown on to the draining-shelves (D) by means of perforated copper shovels. When the temperature has fallen below 100° F.,

further stirring is unnecessary, as below this point the crystals separate slowly. The saltpetre found in large crystals at the bottom of the crystallizing pans is treated as crude saltpetre. The saltpetre on the shelves (D) is then raked into the washing-vats (E), which are 6 feet long, 4 feet wide, and 3 feet 6 inches deep. They have a wooden perforated false bottom, and an outlet hole fitted with a plug. At first the draining-hole is left open and the saltpetre washed with about 70 gallons of water thrown over it in the form of a spray, and then left to drain for half-an-hour. The draining-hole is then closed by means of the plug, and the saltpetre covered with water. After standing for half-an-hour the plug is again withdrawn, and the contents of the vat allowed to drain for another half-hour. Finally the saltpetre is washed a third time, with the draining-hole open, with about 100 gallons of water. The washing-water, all of which runs into a cistern (F) standing below the floor, is used to dissolve the crude saltpetre in the boilers, where it is concentrated by evaporation. The saltpetre remains over-night in the washing-vats, and is then all taken out and stored except about the lowest, 6 inches from the bottom, which is allowed to remain. After three days' storage it will only contain from 3 to 5 per cent. of moisture, and can be used for the manufacture of powder without further drying.

From each charge of 40 cwt. about 25 cwt. of refined saltpetre are obtained.

The mother-liquors are evaporated to about one-quarter of their original volume, being meanwhile constantly stirred. They are then filtered and allowed to crystallize in copper pans. The crystals are put into the boiler to be dissolved, and in a similar manner the mother-liquor is added to the rest during the evaporating process. All saltpetre coming from bags, damaged gunpowder, sweepings, etc., is recovered.

### III. ARTIFICIAL SALTPETRE (CONVERSION SALTPETRE, GERMAN SALTPETRE).

With the exception of in England, saltpetre is now almost exclusively made by the conversion of sodium nitrate by means of potassium chloride.

Sodium nitrate is found in large quantities in the districts of Tarapaca and Atacama in Chile in the form of a solid mass called caliche, which consists chiefly of sodium nitrate and sodium

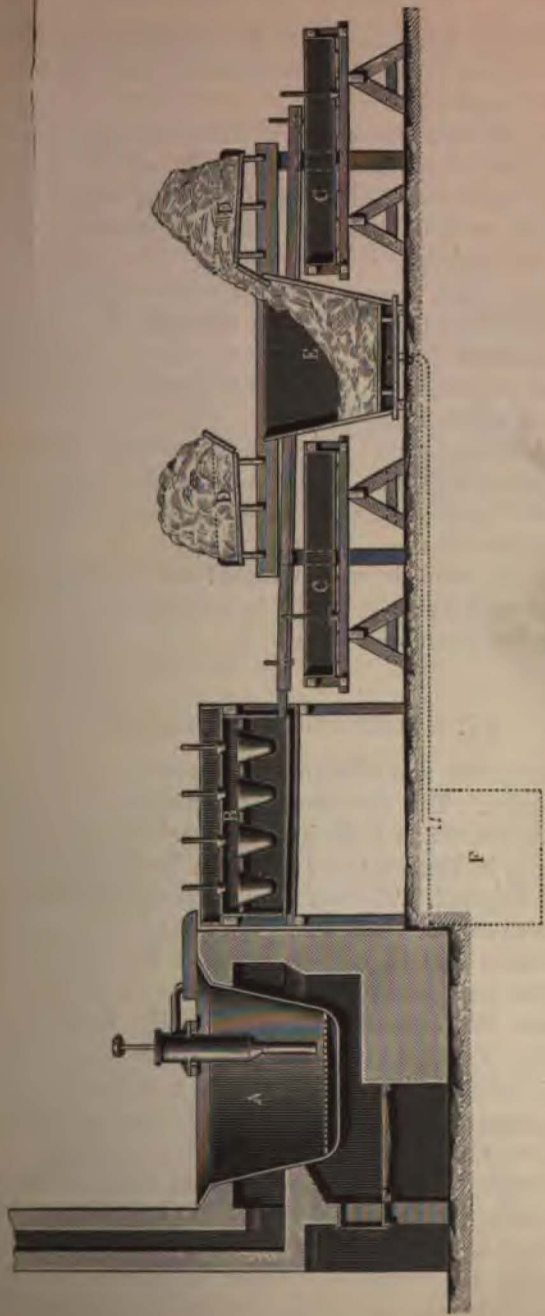

FIG. 2.—One-60th full size.

chloride, with various other salts, sand, clay, etc. The sodium nitrate made from it contains between 94 and 96 per cent. of pure sodium nitrate.

Potassium chloride is obtained, by lixiviation and crystallization, from "Carnallite," a salt occurring in the Stassfurt deposits.

Artificial saltpetre is made by dissolving about 10 parts of sodium nitrate and 9 parts of potassium chloride in mother-liquors coming from previous operations. The solution is made in steam-heated iron vessels provided with a stirring-gear. The solution is evaporated until it has a strength of about 106° Tw. The salt deposited is then taken out, and after the liquor has been allowed to settle for a sufficiently long time, it is filtered and placed in crystallizing pans.

The further treatment is very similar to that used in refining Indian saltpetre, with the exception that the finished saltpetre is further dried on steam-heated tables for the purpose of making it suitable for shipment.

Artificial saltpetre is manufactured on a very large scale, and supplied to gunpowder works in such a state of purity that it does not require further refining.

#### IV. EXAMINATION OF SALTPETRE.

Saltpetre for the manufacture of gunpowder must be of a high degree of purity. The maximum percentage of sodium chloride allowed by various States in their powder factories is not more than 0.033 per cent. in France, 0.010 per cent. in Germany, and 0.005 per cent. in England. The continued lixiviation and washing of saltpetre leaves such a small quantity of impurity in the shape of sodium chloride, that it can be assumed that for all practical purposes other foreign salts are only present to the same extent, and therefore the examination is generally made for sodium chloride only. For this purpose a few grammes of saltpetre are dissolved in distilled water, preferably in a test-tube, by heating, and a few drops of nitrate of silver solution are added, when not more than a trace of opalescence should appear.

In France the silver solution is made to contain 9.68 grammes of nitrate of silver in a litre. This is done by dividing the weight in grammes of any given quantity of the salt by 0.00968, the quotient giving the quantity of water in grammes to be added. One gramme of this normal solution corresponds to 0.0033 gramme of sodium chloride, and is added to a solution of 10 grammes of

saltpetre. The whole is then filtered and divided into two parts, to one of them a solution of sodium chloride is added, and to the other a solution of silver. If the first becomes turbid then there was more, and if the other becomes turbid then there was less, than 0.0033 gramme of common salt contained in the saltpetre.

A further qualitative examination has to be made for sulphates and carbonates by means of barium chloride, and for

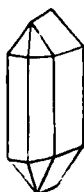
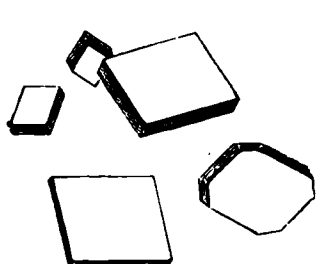

FIG. 3.

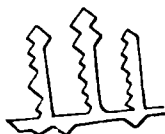

FIG. 4.

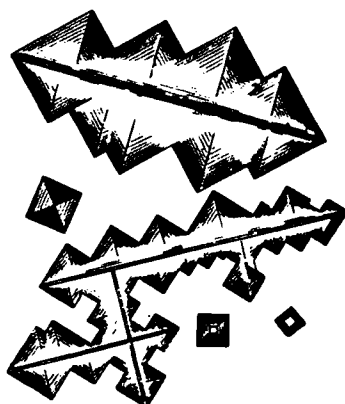

FIG. 5.

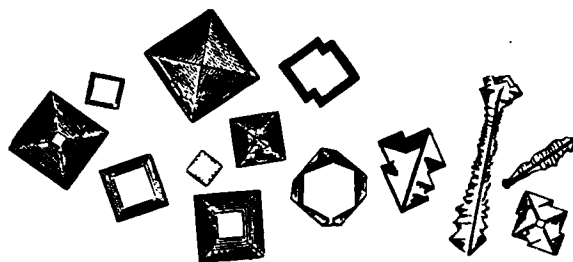

FIG. 6.

calcium and magnesium salts by adding potassium oxalate to the solution of saltpetre after having previously added ammonia to it. Sodium nitrate is recognized by the characteristic yellow colour given to the blow-pipe flame or to the flame produced by saturating the saltpetre with alcohol and lighting it.

For a quantitative examination the moisture is determined by gently heating a weighed quantity in a platinum crucible until the saltpetre just begins to melt, then cooling it under a dessicator, and determining the difference by weighing.

## PRIME MATERIALS AND INGREDIENTS

of lime (the latter containing about 50 per cent. of CaO), and water to about half the height of the apparatus. The heat for the reaction is assisted by the steam-jacket. After stirring for about six hours, steam is introduced into the dissolving vessel, in order to drive out all traces of ammonia.

The receivers are charged with nitric acid of 1.220 specific gravity, which runs through a funnel into the first receiver, and from there by means of taps into the lower ones, in which it is maintained at a level of about 6 to 8 inches. Any ammonia that is not absorbed is returned to the first receiver.

Since the iron of the apparatus is always slightly attacked, there appears, when all the nitric acid is neutralized, the well-known pink reaction of iron and ammonia, which indicates that the operation is finished. The solution is run into a "Montejus" (acid elevator), which forces it through a small filter press. The clear solution then goes to the concentrator, where it is heated at 248° F. for eight hours. The concentrator is a bowl vessel with a pyramidal-shaped bottom. It is covered outside with insulating material, and rests on a wooden frame. In this vessel there is a coil of lead-pipe following the shape of the bottom, through which steam of between 75 and 90 lbs. pressure passes. As soon as the solution is sufficiently concentrated, it is run into crystallizing pans, which, according to the degree of purity desired, are either lead-covered wooden pans, or ordinary iron ones.

A larger plant is illustrated in Fig. 7. In this is (A) the dissolving vessel with a stirring-gear (a) actuated by the cog-wheels (b). B is the Liebig's cooler, C an iron cooling vessel with copper cooling coils, D are receivers for the absorption of ammonia gas, E and E' collecting vessels for the solution, which is carried into the cistern (G) by means of the pipe (F). From here the solution is brought into the vacuum-pan (H). This is in connection with the Liebig's cooler (I), the air-vessel (K), and the air-pump (L). The concentrated solution is run into the crystallizing dishes (M) by means of an india-rubber hose. After crystallization their contents are thrown into the centrifugal machine (N), from which the extracted mother-liquor runs back into the cistern (P), and is used again for evaporation. The ammonium nitrate remaining in the centrifugal machine is freed from excess of moisture in a steam drying apparatus (O).

In some factories the ammonia is made direct from the



of from 1 to 5 yards, and in strata from 2 to 12 feet in thickness. The saltpetre earth or caliche contains from 15 to 65 per cent. of sodium nitrate, and a large quantity of various other salts, such as sulphates, chromates, chlorates, iodates, borates, etc. The locality where the caliche is found extends over an area of many miles. Ochsenius describes it as follows: "Such a locality is in general a rainless and barren desert plain of dreary aspect, extending a great distance, the surface of which seems to be more covered with ruts and *débris* than anything else. The sand, so far as it is not held fast by efflorescences of salt, is blown between the blocks of stone. Those who do not wish to lose all remembrance of the colour of hope must in these localities carry about with them a piece of green paper, yet nevertheless man has made a nest for himself there, and develops an ant-like activity in bringing hidden treasures to the light of day."

According to papers read by Joshua Buchanan and G. M. Hunter, the saltpetre grounds, or pampas, are covered with about 2 inches of sand, on which lie rounded stones, and although some of them weigh over 5 cwt., they still lie on the uppermost layer of sand, into which horses' hoofs would sink 4 inches deep. Under the strata of sand there are about 6 inches of white friable calcium sulphate, and under this a layer of conglomerate of earth and stones up to 10 feet in thickness, then a layer up to 3 feet thick of impure caliche, and finally the real caliche. Under this there lies sometimes gravel, and sometimes fine clay. The characteristic quality of this caliche is its great percentage of iodine, the proportion of which is, as a rule, larger the poorer the caliche is in sodium nitrate. The caliche is not at all uniformly distributed over the surface. It is the duty of the foreman to find out the rich places, and the consequence is that an "oficina," or saltpetre factory, owns many square miles of pampas, from which it is served by means of tramways or carting.

The caliche, as a rule, is worked by driving a bore-hole of about 9 inches diameter on the floor of the deposit. The bore-hole is then widened out by means of a round iron plate fixed on a long pole, and then blasted. The caliche from these operations is broken in a stone-breaker to about 2-inch cubes, and then placed in boiling vats. The construction of these varies in different works. The largest are probably 45 feet long, 8 feet wide, and 9 feet deep, and hold about 75 tons. At about 8 inches from the bottom they have a false bottom, and are so arranged that six of them form a continuous extraction plant, similar in operation to a Shank's extraction

apparatus. Each pan has a series of steam coils, generally five, which keep the water and mother-liquor poured on to the caliche boiling. The extraction is continued until the liquor has a specific gravity of 1.540 to 1.550 at 122° F. It is allowed to rest some time, and then run into settling-tanks, whilst, of course, the change of order takes place as in a Shank's apparatus. The mud settling down is drawn off through mud-holes in the bottom. From the settling-tanks the liquor is run into crystallizing pans, which are made in various sizes up to 24 feet long, 14 feet wide, and 3 feet 4 inches deep. They are 3 inches deeper on one side than on the other, so as to let the mother-liquor drain off. The saltpetre which crystallizes out is placed on inclined platforms, and the mother-liquor allowed to drain back into the crystallizing pans. It is then washed with a little pure water, and when sufficiently dry is thrown on to a deep platform, where it remains until it is packed into bags for exportation. The mother-liquors contain not only all the various impurities, but also all the iodine. As a rule, the apparatus provided are not sufficient to work up the whole of the iodine. As there is a great scarcity of water, and consequently all water in whatever form it may exist has to be used as often as possible, the mother-liquors are repeatedly used for extracting the caliche. Although the iodine exists as an iodide in the distinctly alkaline mother-liquor, nevertheless, the iodine is probably decomposed by the absorption of carbonic acid from the air, and by traces of hydrogen peroxide. The iodine thus liberated is seen above the boiling vats as a purple-coloured vapour.

The treatment of the mother-liquors for recovering iodine need not be considered here.

The nitrate of soda thus obtained contains on an average about 1 or 1½ per cent. of impurities. According to the purpose for which it is to be utilized later on, more or less care is taken to eliminate these impurities. The following is an average analysis of sodium nitrate as it is bought for the manufacture of nitric acid of high percentage:—

NaNO <sub>3</sub>	...	...	96.4000	per cent.
NaCl	...	...	0.6084	"
NaSO <sub>4</sub>	...	...	0.2870	"
Insoluble	...	...	0.1060	"
H <sub>2</sub> O	...	...	2.7050	"
			<hr/>	
			100.1064	

Opinions on the probable origin of native sodium nitrate differ very widely. In Chile the prevailing view is that large



deposits of guano formerly existed where the caliche now is, and that the sea gradually flooded these parts and then receded. The salt water left behind became more and more concentrated by evaporation, and acted upon the guano. Noellner favours the view that the necessary nitrogenous material was supplied by large quantities of seaweed left by the sea, which is supposed to have formerly covered these parts, as it receded. Others again attribute the formation of caliche to the action of ammonia contained in the atmosphere upon decayed feldspathic rocks. In a work dealing specially with the formation of nitrate of soda, Ochsenius explains at some length that, as in the case of the potassium deposits of Germany, mother-liquor salts were washed down, from the Andes, that then guano-dust was carried by the wind into the rainless districts of Atacama and Tarapaca from the large guano deposits on the coast, and came into the mother-liquor salts which had settled there. It is thus that he explains the formation of nitrate of soda.

Pure sodium nitrate crystallizes in blunt, six-membered rhombohedra. It has a salt taste, and absorbs moisture rapidly.

The quantities that will dissolve in 100 parts of water are shown in the following table:—

0° C.	79.75 parts.	60° C.	119.94 parts.
10° "	84.30 "	70° "	129.63 "
20° "	89.55 "	80° "	140.72 "
30° "	95.37 "	90° "	153.63 "
40° "	102.31 "	100° "	168.20 "
50° "	111.13 "	120° "	225.30 "

Sodium nitrate is frequently soluble in saturated solutions of other salts, but sodium chloride and sodium nitrate mutually diminish each other's solubility. On dissolving sodium nitrate in water a marked reduction of temperature takes place. It deflagrates on incandescent charcoal in a similar manner to potassium nitrate, but its flame has a yellow colour.

The examination of sodium nitrate is generally made quantitatively. Enormous quantities are imported, chiefly to London, Liverpool, and Hamburg. It is customary to have a sample drawn, and an analysis made in Chile, which is checked by European analysts. It is on the basis of this examination that the cargo is bought. This examination is as follows:—After a weighed quantity of the sample has been thoroughly dried to determine the percentage of water, the percentage of sodium

chloride in it is determined by the nitrate of silver test, the percentage of sulphates by the barium chloride test, and the rest considered to be pure sodium nitrate. The amount by which this falls short of 100 per cent. is called the *refraction*: thus saltpetre with 4 per cent. refraction contains 96 per cent. of pure sodium nitrate. This method of examination is open to many objections, on which account, and also because absolute accuracy of results cannot always be relied upon from a laboratory making a very large number of analyses, it has become more and more customary to make a complete analysis of the samples in the factories themselves.

The method of conducting such an analysis is the following:— First of all a trustworthy average sample is taken. For this purpose a small quantity is taken from each bag, care being taken that as far as possible large and small crystals are taken in proportions corresponding to the general contents of the bag. This is necessary, because the small ones have, in consequence of their comparatively larger surface, more impurities from the mother-liquor adhering to them. The sample thus taken is then pounded in a mortar, and the following tests made:—

*Determination of Water.*—About 10 grammes of sodium nitrate are weighed in a watch-glass, dried at a temperature of 120° C., and cooled over sulphuric acid in a desiccator; or 10 grammes of saltpetre are weighed in a porcelain crucible and heated over a small flame until the saltpetre just begins to melt. The difference on repeated weighing gives the percentage of moisture.

*Determination of Salt.*—About 10 grammes of sodium nitrate are weighed in a watch-glass, dissolved in a porcelain dish with distilled water, and titrated with tenth-normal silver solution, some potassium chromate having been previously added to the solution. The titration is finished as soon as the silver solution produces a red precipitate of silver chromate. One cubic centimetre of tenth-normal silver solution corresponds to 0.00585 gramme of sodium chloride.

*Determination of Insoluble Residue.*—100 grammes of sodium nitrate are dissolved in distilled water, the solution is filtered through a dried and weighed filter, and the residue dried and weighed.

*Determination of Sulphates.*—The filtrate from the determination of the residue is concentrated by evaporation and boiled, and an excess of barium chloride solution added. The barium sulphate precipitated is filtered, dried, and calculated for sodium nitrate.

*Determination of Pure Sodium Nitrate.*—This is done by direct

determination of nitrogen, the most suitable apparatus being Lunge's nitrometer. About 0.45 gramme of saltpetre is weighed out, and about 5 cubic centimetres of sulphuric acid added to it. The whole is rinsed into the funnel of the nitrometer with about 10 cubic centimetres of dilute sulphuric acid. The analysis is then proceeded with in the usual manner.

Sodium nitrate used for the manufacture of nitric acid should contain at least 96 per cent. of pure sodium nitrate. As a rule, about 0.75 per cent. of sodium chloride is tolerated, but commercial nitrate of soda frequently does not contain more than 0.3 per cent. sodium of chloride. There should not be more than about 3 per cent. of water, as the less water there is in the nitrate of soda, the stronger will the nitric acid made from it be.

Nitrate of soda itself is an ingredient of some explosives, but as a rule there is no higher standard of purity demanded than that required for the manufacture of nitric acid. Pure crystallized sodium nitrate is only used for certain powder mixtures, where it takes the place of potassium nitrate. In these cases the practical absence of chlorine (that is, less than  $\frac{1}{10000}$ ) is of importance.

The presence of chlorine in sodium and potassium nitrate can, under favourable circumstances, give rise to the formation of nitrogen chloride, and hence to very dangerous conditions.

### 3. AMMONIUM NITRATE.

Ammonium nitrate is an artificial product, its occurrence in nature being quite exceptional.

The method of manufacture most used is the neutralization of nitric acid by means of ammonia vapour. It can be made chemically pure by dissolving ammonium carbonate in pure nitric acid, evaporating the solution until a fine crystalline coating appears on the surface, and then crystallizing out.

On a large scale ammonium nitrate is produced by causing ammonium sulphate and lime to re-act upon each other under heat, and absorbing the liberated gaseous ammonia in diluted nitric acid.

An apparatus suitable for working on a small scale consists of a wrought-iron dissolving-tank, fitted with a steam-jacket and stirring-gear. The ammonia developed passes first through a Liebig's cooler, then through a cooling-worm, and finally through a series of receivers containing some nitric acid. The dissolving vessel is charged with about 2 cwt. of sulphate of ammonium,

2.4 cwt. of lime (the latter containing about 50 per cent. of  $\text{CaO}$ ), and water to about half the height of the apparatus. The heat due to the reaction is assisted by the steam-jacket. After stirring for about six hours, steam is introduced into the dissolving vessel, in order to drive out all traces of ammonia.

The receivers are charged with nitric acid of 1.220 specific gravity, which runs through a funnel into the first receiver, and from there by means of taps into the lower ones, in which it is maintained at a level of about 6 to 8 inches. Any ammonia that is not absorbed is returned to the first receiver.

Since the iron of the apparatus is always slightly attacked, there appears, when all the nitric acid is neutralized, the well-known pink reaction of iron and ammonia, which indicates that the operation is finished. The solution is run into a "Montejus" (acid elevator), which forces it through a small filter press. The clear solution then goes to the concentrator, where it is heated at  $248^{\circ}\text{F}$ . for eight hours. The concentrator is a lead vessel with a pyramidal-shaped bottom. It is covered outside with insulating material, and rests on a wooden frame. In this vessel there is a coil of lead-pipe following the shape of the bottom, through which steam of between 75 and 90 lbs. pressure passes. As soon as the solution is sufficiently concentrated, it is run into crystallizing pans, which, according to the degree of purity desired, are either lead-covered wooden pans, or ordinary iron ones.

A larger plant is illustrated in Fig. 7. In this is (A) the dissolving vessel with a stirring-gear (a) actuated by the cog-wheels (b). B is the Liebig's cooler, C an iron cooling vessel with copper cooling coils, D are receivers for the absorption of ammonia gas, E and E' collecting vessels for the solution, which is carried into the cistern (G) by means of the pipe (F). From here the solution is brought into the vacuum-pan (H). This is in connection with the Liebig's cooler (I), the air-vessel (K), and the air-pump (L). The concentrated solution is run into the crystallizing dishes (M) by means of an india-rubber hose. After crystallization their contents are thrown into the centrifugal machine (N), from which the extracted mother-liquor runs back into the cistern (P), and is used again for evaporation. The ammonium nitrate remaining in the centrifugal machine is freed from excess of moisture in a steam drying apparatus (O).

In some factories the ammonia is made direct from the

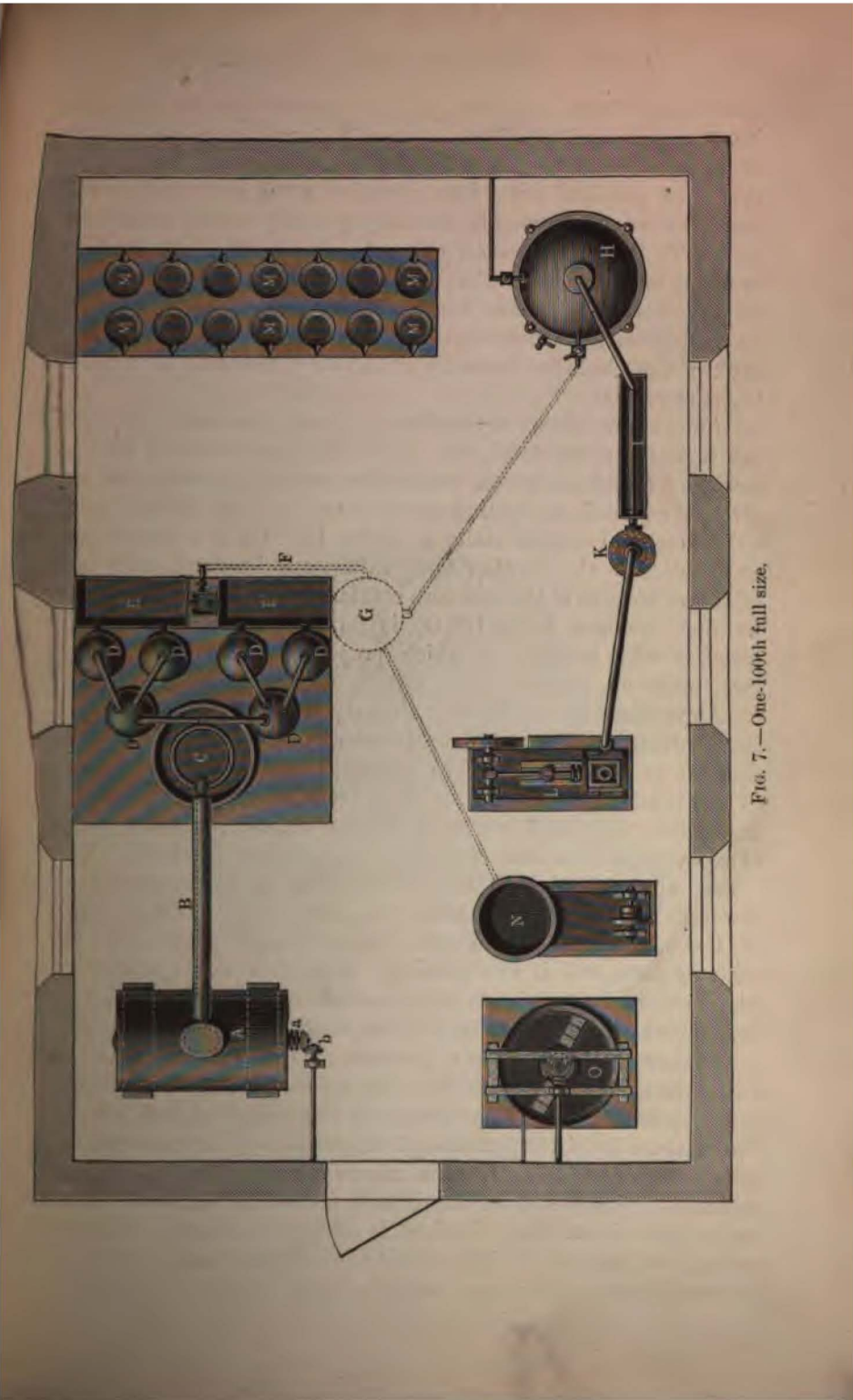

FIG. 7.—One-100th full size.



ammoniacal liquor produced in the manufacture of coal gas. Many apparatus have been designed for this purpose, some of sufficient size to treat 2200 gallons per hour, but unless they are provided with very effective distilling columns and gas purifiers, the ammonia gas they produce is not sufficiently pure. To be effective, such apparatus is of necessity expensive to erect, and the comparatively small quantity used in explosive factories does not as a rule warrant the necessary outlay.

Full details of such apparatus are given in Lunge's 'Handbook of the Coal Tar Industry,' Thorpe's 'Dictionary of Applied Chemistry,' etc.

Ammonium nitrate crystallizes in large columnar crystals, it has a bitter saline taste, and its crystals can be bent with a crackling sound. Like all ammonium salts, ammonium nitrate gives off ammonia on heating or exposure to air, and becomes acid.

Ammonium nitrate melts at about 100° C., and decomposes at about 200° C. Neither temperature can be fixed with certainty on account of the moisture constantly absorbed. On decomposition, nitrogen oxide ( $N_2O$ ) is formed. It can be melted together with sulphur, of which property use has occasionally been made for explosives.

Ammonium nitrate is very strongly hygroscopic, 10 parts of it dissolving in 5 parts of cold water, whereby a considerable decrease of temperature takes place. This property is utilized in a well-known freezing mixture consisting of 5 parts of ammonium nitrate, 5 parts of sodium chloride, and 12 parts of snow, which is capable of producing a temperature of—32° C.

As a rule, ammonium nitrate is tested for its percentage of nitrogen in Lunge's nitrometer, or it may be tested by another of the many methods in use. A red colour shows that it contains iron, and if the presence of iron in any quantity is suspected, it is examined in the usual manner. Free acid is determined by titrating the solution with soda solution.

Benker has patented a process for the manufacture of ammonium nitrate from sodium nitrate and ammonium sulphate. He proposes to mix the solutions of the two salts and submit the mixture to a temperature of at least—15° C., produced by a freezing machine. By this freezing ammonium nitrate is separated, whilst sodium sulphate remains in solution. The ammonium nitrate thus obtained is said to be of extraordinary purity, and not at all hygroscopic. This process has not yet, however, been worked on a manufacturing scale.

## 4. BARIUM NITRATE.

In exceptional cases, where the sensitiveness of saltpetre to moisture is objectionable, barium nitrate is used. It can be made either by treating barium carbonate with dilute nitric acid, or by decomposing barium chloride by sodium nitrate.

Barium carbonate is found in England as the mineral known as "Witherite." It is generally contaminated, however, with iron. Pieces of about the size of a walnut are put into dilute nitric acid, and allowed to stand until all the iron is precipitated and the liquid has become neutral. The liquor is then drawn off, filtered, evaporated, and crystallized in the same manner as ammonium nitrate.

In another method a hot solution of barium chloride is mixed

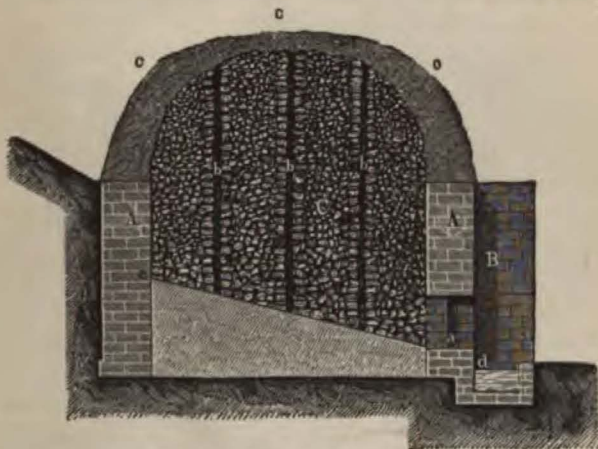

FIG. 8.—One-200th full size.

with a hot solution of sodium nitrate, and continually stirred during the mixing, whereby barium nitrate separates out as a meal-like mass of fine crystals, and salt remains in the solution. The solution is decanted, and the crystals are washed.

Barium nitrate is of a pure white colour, and free from water of crystallization. It dissolves in 12 parts of cold water, and in three parts of hot, and is therefore not sensitive to the action of the moisture in the air. Its specific gravity is 3.23.

5. LEAD NITRATE. (*Nitrate of Lead.*)

This is made by dissolving finely-ground litharge or lead carbonate in dilute nitric acid, decanting the clarified solution and

crystallizing it. Although lead nitrate is only slightly hygroscopic, and although on account of its easy decomposition it would seem to be very suitable for the manufacture of explosives, it is, however, just this latter quality which precludes its use. On heating slightly it gives off nitrous acids freely.

In some countries—in Great Britain, for instance—its use for explosives is expressly prohibited.

## 6. SULPHUR.

### (a) *Crude Sulphur.*

Up to about two years ago, the sulphur for the manufacture of explosives came chiefly from Sicilian mines, of which there are about 400, having a yearly output of about 330,000 tons, and employing about 30,000 hands. It occurs unevenly distributed in

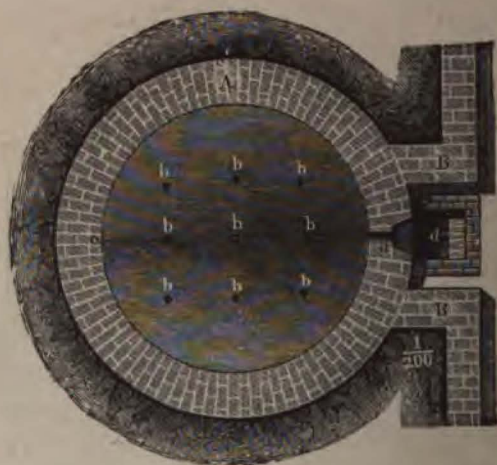

FIG. 9.

the limestone. The mineral from the mines usually contains from 6 to 25 per cent. of sulphur, although sometimes it contains as much as 70 per cent.

The extraction of the sulphur from the ore is carried out at the mines in a very primitive manner. Heaps of the form illustrated in Figs. 8 and 9, the so-called "Calcaroni," are made, consisting of a brick pit with an inclined bottom made from hard tamped leavings. The bottom also inclines towards the centre, so that all sulphur can run off into the pit. In this pit the ore is piled up, and the air channels (b b) formed.



Through these the mineral is ignited simultaneously, and a layer of powdered leavings (c c) is placed over the whole to cover the heap. Such heaps contain between 400 and 800 tons of mineral. The time of burning is about one month, and as soon as the liquid has collected up to the level of the opening (a), the drawing off of the sulphur begins, this taking from four to five weeks, until the heap is completely burnt out. The molten sulphur is run into wooden forms, in which it solidifies into cakes of about 130 lbs. each.

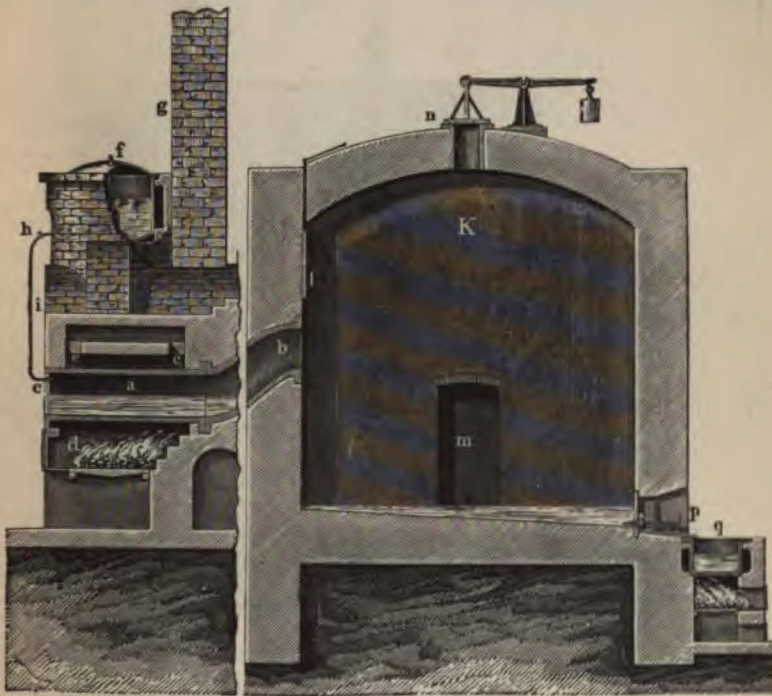

FIG. 10.—One-100th full size.

In various parts of Sicily other processes for extracting the sulphur have been recommended and partly used, but burning in heaps is still the method most generally practised.

The so-called crude sulphur, which is sold as such, still contains about 3 per cent. of earthy impurities. The gunpowder factories have therefore to re-purify the whole of the sulphur before using it.

Within the last few years a new and very important source

of supply for sulphur has been found in the "Chance-Claus" process. The residue formed in the manufacture of soda, which consists chiefly of calcium sulphide, was always a great burden to soda manufacturers, who could do nothing but throw it on enormous heaps. By the "Chance-Claus" process all the residue may be recovered. For this purpose it is stirred with water into a paste, and run into large cast-iron vessels (carbonizers). Carbonic acid is produced by burning limestone in kilns, and forced by means of large blowers into the carbonizers, calcium carbonate and sulphuretted hydrogen being produced by the

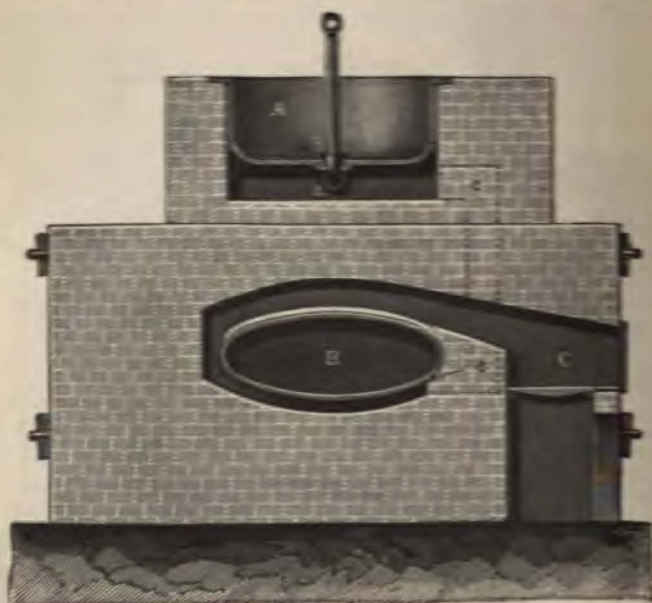

FIG. 11.—One-50th full size.

reaction that takes place. The sulphuretted hydrogen goes into a gas-holder, and is then mixed with air and burnt in the so-called "Claus Kiln." The products of the combustion contain steam and sulphur, and of the latter part is condensed as a liquid in the sulphur pit, and part is sublimed as flowers of sulphur in chambers.

The sulphur obtained by the "Chance-Claus" process is of great purity, and can be used for the manufacture of explosives without further treatment. In Sweden sulphur is chiefly manufactured from pyrites. Flowers of sulphur (sublimed sulphur) are unsuitable for the manufacture of explosives on account of

their containing considerable quantities of sulphurous and sulphuric acid.

(b) *Refining of Sulphur.*

The apparatus chiefly used in Marseilles, where there are a number of factories for the refining of sulphur, was designed by Lamy, and is illustrated in Fig. 10. It consists of two cylinders (a), 5 feet and 1 foot 8 inches diameter, round which the flame of the fire (d) circulates. The cylinders are closed at the front by a movable lid (c), and are connected at the back by a bend (b) with the condensing-chamber (K). This chamber is square, and

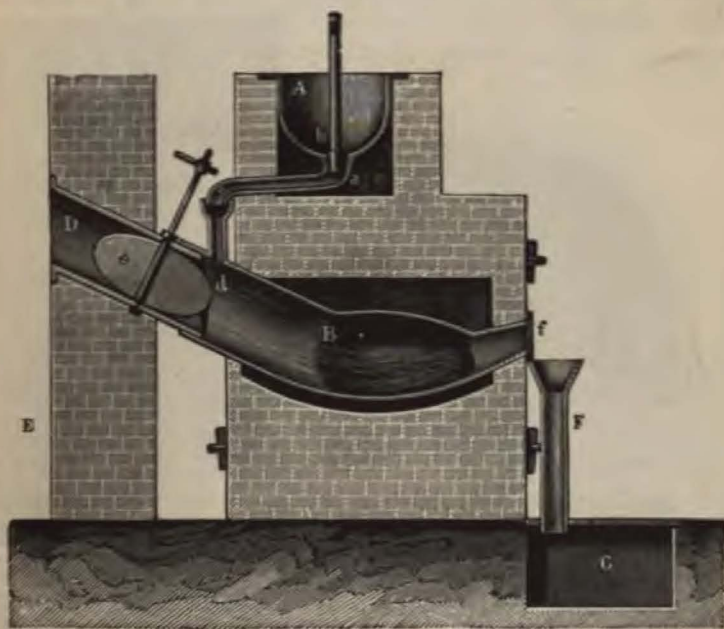

FIG. 12.—One-50th full size.

is of about 3000 cubic feet capacity. It is emptied through the door (m), and is fitted with a safety-valve (n). The liquid sulphur condenses in a vessel (q) standing outside, into which it runs through a draw-off hole (p). The sulphur is first melted in the pre-heater (f), from which it is drawn off in quantities of about 6 cwt. alternately into one cylinder or the other. The flue-gases pass at *ee* under the pre-heater, and from there into the chimney (g). The damper (l) is for alternately shutting off the cylinders. The whole operation occupies eight hours.



Another apparatus, which was constructed for the Government refinery at Marseilles by Court and Déjardin, is illustrated in Figs. 11 and 12. At the bottom of the pre-heater (A) there is a large opening with a stopper (b), through which the molten sulphur runs into the still (B). The still is of lenticular shape, with two sockets (f and d), and is cast in one piece. The lead pipe (D) connects the still with the chamber, and is fitted with the valve (e). The flame of the fire (c) first passes over the upper part

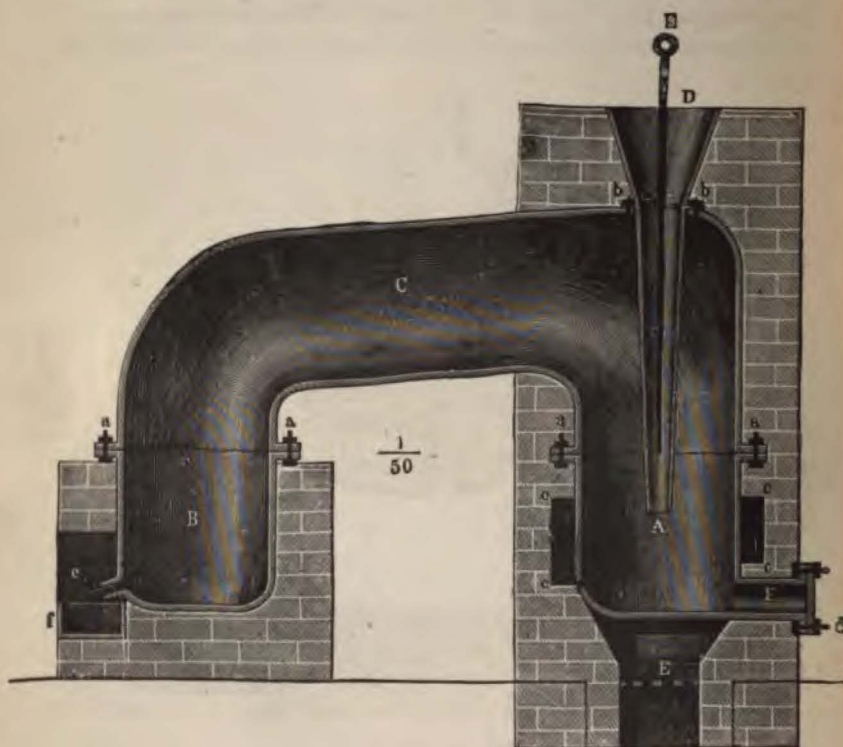

FIG. 13.

of the still, then under the same, and then under the pre-heater. The residue left in the still is discharged after lifting the cover (f), and is thrown into the cistern (g) through the pipe (F), where it is cooled. The pre-heater is charged with about 12 cwt. of crude sulphur, and one charge is distilled in four hours, so that in twenty-four hours 72 cwt. are distilled off. This requires 10 cwt. of coal. With both operations large quantities of flowers of sulphur are, of course, obtained in the chamber.

At Spandau a pot bricked into a furnace, and holding about  $1\frac{1}{2}$  cwt., is used for melting the sulphur. As soon as the sulphur is liquid, it is ladled into enamelled iron pots, each of which holds about 56 lbs., and which have been washed out with a cloth dipped in hot water. A gauze sieve is placed over the top of the pots to filter the sulphur as it runs into them. It is then allowed to cool gradually, whereby it changes from the prismatic into the ordinary rhombic form, and becomes extremely brittle. It is stored in kegs, holding about 2 cwt. each. The residue remaining in the pot and on the filter cloth is re-melted.

In other German factories, where they use the ashes from sulphuric acid kilns, the apparatus shown in Fig. 13 is used. It consists of a still (A), which is connected with the condenser (B) by a pipe (c), and heated by a fire (E). The crude sulphur is intro-

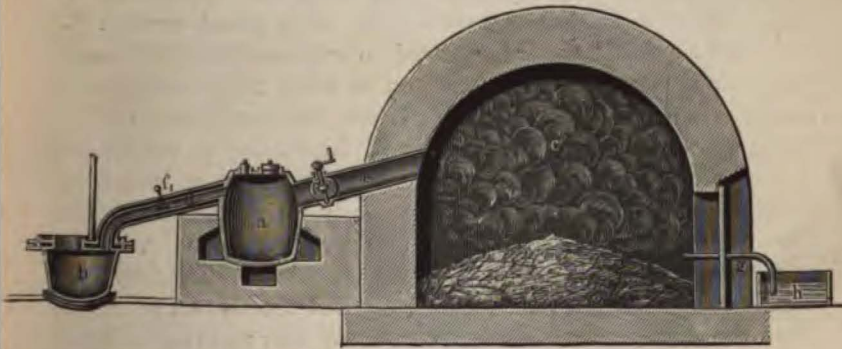

FIG. 14.—One-125th full size.

duced through the funnel (D), the end of which dips under the surface of the liquid. The opening of the funnel is kept free by means of an iron rod (E). The socket (F) with its cover (d) is for cleaning the still. The sulphur condensed in B is run into the vessel (f) through the socket (e).

At the Royal Gunpowder Factory, Waltham Abbey, an apparatus similar to that of Court and Déjardin is used. It is shown in Fig. 14. An iron still (a) is set in a brickwork furnace. It has a heavy removable lid, luted on with clay. There is an opening 4 inches wide in it, which is closed by a conical iron plug. Two pipes lead away at right angles from this still, one (e), which is 16 inches diameter, to a large arched chamber (c), the other, of 5 inches diameter, into an iron collecting vessel (b), which is placed below the still. The latter has a jacket through which cold water circulates. It can be alternately closed and opened by

means of the valve (f). A leaden pipe goes from the cover of the collector into a small wooden chamber lined with lead, in which those vapours which have not been condensed in the pot are deposited as sulphur in the same manner as in the chamber (c).

The still is charged with  $5\frac{1}{2}$  cwt. of broken crude or "grough" sulphur, as it is called. As soon as a fine yellow vapour begins to escape from the opening in the cover, the plug is inserted and the vapours are led into the chamber (c), where the sulphur is deposited on the walls and on the arch in the form of "flowers of sulphur." The air in the chamber escapes through a small pipe (g) leading from the bottom of the chamber into a vessel (h) which is filled with water, in which any sulphurous or sulphuric acid is absorbed. After about three hours the vapour turns to a dark violet colour. The pipe leading to the chamber is then closed, and the one leading to the collecting vessel opened. At the same time cold water is allowed to run through the pipe (d). The sulphur vapour condenses in the tube, and runs into the collector as a clear yellow liquid. When the operation is finished, the sulphur is allowed to cool until it reaches a temperature of about  $230^{\circ}$  F., which takes an hour. It is then ladled into wooden tubs which have been previously moistened with water. The connection with the chamber is then again made, so that any vapours that may still form can pass into it. The impurities remaining in the still are thrown away, and the flowers of sulphur from the chamber treated as "grough" sulphur and re-distilled.

#### (c) *Examination of Sulphur.*

In Germany crude sulphur is examined for sulphuric and sulphurous acid by grinding it finely and boiling it with distilled water. Blue litmus paper dipped into the liquid should not become red. Most factories return such sulphur to the supplier, for otherwise the acid would have to be removed by pulverizing and washing the sulphur containing it. To detect the presence of earthy matter and oxides, a portion of the sulphur is powdered and put into a porcelain crucible. It is then completely burnt under a bell-jar, when no residue should remain.

If the sulphur has a bright yellow or reddish colour, it contains arsenic. To detect this some of the sulphur is finely ground and boiled for a long period with nitric acid. The nitric solution is decanted and neutralized with ammonium carbonate. On adding



nitrate of silver, the characteristic yellow silver arseniate should not precipitate in pure sulphur. An alternative method is to treat the sulphur with dilute ammonia and to add hydrochloric acid, when a yellow precipitate of sulphuric arseniate indicates the presence of arsenic.

In Belgium sulphur is mixed with four times its weight of saltpetre, put into a warm crucible, and heated. The molten mass is dissolved, and dilute sulphuric acid added. After evaporation alcohol is poured on to the residue and a strip of zinc dipped in the liquid. If this is covered with a layer of black scales, the sulphur contains arsenic. No sulphur that contains any arsenic should be used for the manufacture of gunpowder.

In France a small quantity, as representative of the whole as possible, is taken from each block. All these samples are mixed, and thus an average sample for the day is obtained. This sample is divided by sifting into three sizes of grains. From each size about a quarter is taken, and the whole ground in a mortar: 500 grammes of this mixture are used for the test. It is heated to a red heat in a small crucible, then cooled, and the residue carefully taken out and weighed. Sulphur of the third quality should not contain more than 15 grammes of residue.

The determination of acid is done in the same way as at Spandau, and the examination of the refined sulphur in a similar manner to that of the crude sulphur. In England the maximum residue allowed after burning is not more than 0.25 per cent. In Switzerland and in France no residue at all is allowed.

Sulphur is solid at ordinary temperature, insoluble in water, slightly soluble in alcohol, tar, and benzene, and in fatty or essential oils generally; 100 parts of carbon di-sulphide dissolve 73 parts of sulphur when heated and 38 parts when cold. The specific gravity of sulphur is 2.087. It melts at 111° C. (232° F.), and boils at 460° C. (860° F.). At 112° C. it is bright yellow and very liquid; at 140° C. it is dark yellow and very viscous. Between 170° and 200° C. it becomes very thick and dark-brown, and will not flow even if the crucible is upset. If heated above this temperature, it again becomes liquid. At 440° C. it begins to boil, and gives off red-brown vapours. If at this temperature it is poured into cold water, it sets into a plastic transparent elastic mass very much like india-rubber.

Sulphur may be obtained in oblique-rhombic monoclinic crystals by heating it to 120° C., allowing it to partially solidify, and then pouring off the remaining liquid part. From a solution in carbon di-sulphide, benzol, etc., sulphur separates out in transparent

rhombic octahedrae. Similar crystals are also obtained on subliming sulphur.

Sulphur is a bad conductor of electricity, but on rubbing a strong electric charge is set up on it, and on this account it is difficult to grind it in a mortar, as it clings together in lumps on the pestle. This electrical property is of great importance in the manufacture of gunpowder, since through neglecting to take proper precautions it is quite possible for dangerous fires and even explosions to occur through the electrical charges set up by friction against the sulphur.

### 7. CHARCOAL.

Now-a-days the carbonizing of wood is considered as a distillation of the volatile constituents and the utilization of the residue. If wood is heated in a closed vessel, it loses first of all its moisture, and at about 284° F. the more easily volatile components distil off. Numerous products of the destructive distillation of wood are formed at the same time, which distil over as gaseous, aqueous, and tar bodies, and which are mostly condensed by cooling. The non-volatile part of the wood becomes gradually poorer in nitrogen, hydrogen, and oxygen, and ultimately forms a solid residue, which is more or less black and hard, according to the temperature it has been subjected to.

The charcoal most suitable for the manufacture of gunpowder is the one which is the most readily ignited, burns most quickly, and gives at the same time the least quantity of ash. Another important factor is the porosity of the charcoal. Tough charcoal naturally burns more slowly, and consequently diminishes the rate of combustion of the powder. Proust submitted a number of cellulose bodies to charring, and determined the rate of combustion of the charcoals obtained. He used a mixture of  $\frac{1}{4}$  grammes of saltpetre to 0.775 gramme of charcoal, which was placed in copper tubes 60 millimetres long and 6 millimetres in diameter, and ignited the mixture by a little meal powder placed on the top. The first table on p. 59 shows the results he obtained.

He found that some charcoals, such as those from wheat, rice, galls, etc., would not burn at all under these conditions. On account of their containing silicious matter, straw and other grasses and stalks also gave charcoals which had very slow rates of combustion. On the other hand, charcoal made from decayed wood, especially willow and red beech, was easily friable, and highly inflammable, and left very little residue on burning. He



Mixture of 4 grammes of saltpetre and 0.75 gramme of charcoal made from—	Duration of combustion in seconds.	Weight of residue in grammes.
Hemp stalks ... ..	10	0.775
Asphodel stalks ... ..	10	0.775
Vine stalks ... ..	12	1.275
Chickpea stalks ... ..	13	1.355
Pine-wood ... ..	17	1.936
Dogwood ... ..	20	1.550
Spindle-wood ... ..	21	1.746
Hazel-wood ... ..	23	1.936
Piment stalks ... ..	25	2.325
Maize straw ... ..	25	2.450
Chestnut-wood ... ..	26	2.325
Walnut-wood ... ..	29	2.130
Grains of maize ... ..	45	2.774
Coke ... ..	50	2.900
Sugar ... ..	70	3.100

also found that the bark gave a less inflammable charcoal and one with less ash than the wood itself. The more cellulose the wood contains, the more suitable for making explosives in general will be the charcoal obtained from it. For this reason soft and light woods are adopted in practice, and as a rule the bark is stripped off them before charring.

The kind of charcoal and also the quantity obtainable varies with different kinds of woods. Violette submitted 72 different woods which had been previously dried at 150° C. to a charring at a temperature of 300° C. The following table shows the various kinds of woods in the order of their yield of charcoal:—

Number.	KIND OF WOOD.	DRYING.				CHARRING.			NOTES.
		Weight of the wood.		Loss.		Weight of the wood dried previously at 150° C.		Quantity of charcoal obtained from 100 parts of wood.	
		Before drying.	After drying.	Off weight of dry wood.	Per cent.	Before charring.	After charring.		
1	Cork ... ..	26.52	25.00	1.52	5.75	25.00	15.70	62.80	—
2	Ebony ... ..	154.29	141.50	12.79	8.39	141.50	76.85	54.30	—
3	Satin-wood ... ..	83.08	74.00	9.08	10.93	74.00	38.50	52.00	—
4	Decayed willow ... ..	—	—	—	—	23.00	12.00	52.17	—
5	Wood from <i>Herculeanum</i> ... ..	1.50	1.30	0.20	13.33	49.50	24.60	49.69	{ Found under the ruins of <i>Herculeanum</i> .
6	Wheat Straw ... ..	66.93	58.20	8.73	13.13	58.20	24.80	46.99	—
7	Oak ... ..	151.30	128.00	23.30	15.40	128.00	59.00	46.09	—
8	Yew ... ..	194.14	175.20	18.94	9.75	175.20	80.70	46.06	—

Number.	KIND OF WOOD.	DRYING.				CHARRING.			NOTES.  (The following numbers give the age of the wood in years.)
		Weight of the wood.		Loss.		Weight of the wood dried previously at 150° C.		Quantity of charcoal obtained from 100 parts of wood.	
		Before drying.	After drying.	Off weight of dry wood.	Per cent.	Before charring.	After charring.		
9	Mahogany ... ..	115.25	98.00	17.25	8.80	98.00	44.00	44.89	—
10	Bois de lettre ... ..	91.17	77.50	13.67	15.00	77.50	34.30	44.25	—
11	Oak ... ..	94.62	81.60	13.02	13.76	81.60	35.70	43.75	Pieces of a savage's lance.
12	Juniper ... ..	110.33	67.30	43.03	39.00	67.30	29.00	43.07	8 to 10
13	Lignum vite ... ..	309.54	278.50	31.04	10.03	278.50	116.60	41.86	—
14	Pine (Pinus maritima)	89.48	47.00	42.48	47.47	47.00	19.50	41.48	10
15	Poplar (leaves) ... ..	24.20	10.50	13.70	56.61	10.50	4.30	40.95	15
16	Poplar (root) ... ..	34.94	22.00	14.94	37.00	22.00	9.00	40.90	ditto
17	Pine (pin sauvage) ... ..	69.20	37.30	31.90	46.10	37.30	15.20	40.75	10
18	Fungus growing on willows ... ..	62.36	49.20	13.16	21.32	49.20	20.00	40.64	3 to 5
19	Box-wood ... ..	82.00	71.70	11.70	12.56	71.70	29.00	40.44	—
20	Lotus (alizier, drou- lier) ... ..	148.11	68.40	79.71	51.91	68.40	27.60	40.35	8 to 10
21	Larch ... ..	132.33	95.50	36.83	27.83	95.50	38.50	40.31	10 ,, 12
22	Palm ... ..	92.05	79.50	13.55	13.63	79.50	31.40	39.49	—
23	Thuja canad. ... ..	72.16	50.70	21.46	29.11	50.70	20.00	39.44	12 to 15
24	Hemp stalks ... ..	56.38	51.50	4.88	14.23	51.50	20.20	39.22	—
25	Clematis ... ..	88.65	43.00	45.65	51.50	43.00	16.70	38.83	4 to 5
26	Rushes ... ..	14.67	13.00	1.67	11.39	13.00	5.00	38.46	—
27	Cocoa-palm ... ..	91.30	77.50	13.80	15.12	77.50	29.40	37.93	—
28	Carded cotton ... ..	30.70	27.80	2.90	9.44	27.80	7.40	37.41	—
29	Elder ... ..	197.29	141.50	55.79	28.02	141.50	52.80	37.31	8 to 10
30	Ailanthus (Vernis du Japon) ... ..	112.07	78.60	33.47	29.91	78.60	29.30	37.27	5 ,, 6
31	Wild rose ... ..	112.06	82.50	29.56	26.38	82.50	30.70	37.21	10
32	Honeysuckle ... ..	87.01	51.40	35.61	40.93	51.40	19.00	36.96	4 to 5
33	Spindle-wood ... ..	86.89	56.00	30.89	35.55	56.00	20.50	36.60	8 ,, 10
34	Vine ... ..	44.19	37.50	6.69	15.15	37.50	13.76	36.53	10 ,, 12
35	Chestnut ... ..	61.48	40.20	21.28	34.61	40.20	14.50	36.06	10 ,, 15
36	Cytisus ... ..	66.80	47.20	19.60	29.33	47.20	17.00	36.01	15 ,, 20
37	Red currant ... ..	90.83	68.70	22.13	24.36	68.70	24.50	35.66	3 ,, 4
38	Meallr ... ..	44.04	38.50	5.54	16.16	38.50	13.70	35.57	8 ,, 10
39	Cherry ... ..	188.63	121.00	67.63	35.85	121.00	43.00	35.53	15 ,, 20
40	Aspen ... ..	105.10	91.50	13.60	12.94	91.50	32.00	34.97	—
41	Bladler senna (baguen- audier) ... ..	65.76	54.50	11.26	17.12	54.50	19.00	34.85	5 to 6
42	Ivy ... ..	82.06	61.00	21.06	25.67	61.00	21.20	34.75	15 ,, 20
43	Whitethorn ... ..	167.40	111.50	45.90	27.88	111.50	38.70	34.70	8 ,, 10
44	Plane-tree wood ... ..	125.33	108.00	17.33	13.82	108.00	37.50	34.69	10
45	Apple-wood ... ..	169.85	147.00	22.85	13.99	147.00	51.00	34.69	7 to 8
46	Elm ... ..	134.27	122.00	12.27	9.13	122.00	42.20	34.59	8 ,, 10
47	Hornbeam ... ..	125.21	104.50	20.71	16.54	104.50	36.00	34.44	15 ,, 20
48	Alder ... ..	98.58	84.00	14.58	14.90	84.00	28.90	34.40	8 ,, 10
49	Berberis ... ..	93.09	66.50	26.59	28.57	66.50	22.80	34.28	10
50	Furze (ajonc) ... ..	122.58	95.50	27.08	22.86	95.50	32.70	34.24	3 to 5
51	Birch ... ..	112.73	70.80	41.93	37.20	70.80	24.20	34.17	10 ,, 12
52	Plum ... ..	250.50	182.00	68.50	27.34	182.00	62.00	34.06	7 ,, 8
53	Sycamore ... ..	135.04	84.40	50.64	37.50	84.40	28.50	33.76	12 ,, 15

Number.	KIND OF WOOD.	DRYING.				CHARRING.			NOTES.  (The following numbers give the age of the wood in years.)
		Weight of the wood.		Loss.		Weight of the wood dried previously at 150° C.			
		Before drying.	After drying.	Off weight of dry wood.	Per cent.	Before charring.	After charring.	Quantity of charcoal obtained from 100 parts of wood.	
54	Maple ... ..	122.68	94.80	27.88	22.72	94.80	32.00	33.75	6 to 7
55	Willow ... ..	95.91	81.50	14.41	15.03	81.50	27.50	33.74	8 .. 10
56	Dogwood ... ..	125.13	108.00	17.13	13.69	108.00	36.30	33.61	2 .. 3
57	Robinia ... ..	100.46	67.90	33.06	32.31	67.90	22.70	33.42	10 .. 12
58	Cornus sanguinea ... ..	164.41	90.50	73.91	43.80	90.50	30.20	33.36	4 .. 5
59	Broom ... ..	73.90	63.00	10.90	14.85	63.00	21.00	33.33	3 .. 5
60	Ash ... ..	155.76	120.20	26.50	17.39	120.20	43.00	33.28	30 .. 40
61	Quince ... ..	104.54	70.00	34.54	33.04	70.00	23.30	33.28	8 .. 10
62	Hazel ... ..	106.78	75.60	31.18	20.20	75.60	24.80	32.79	4 .. 5
63	Mountain ash ... ..	118.15	96.00	22.15	18.75	96.00	31.40	32.70	ditto
64	Holly ... ..	181.35	113.00	68.35	37.69	113.00	36.40	32.21	8 to 10
65	Privet ... ..	113.65	78.00	35.65	31.22	78.00	25.00	32.05	ditto
66	Snowball ... ..	117.93	95.20	22.73	19.27	95.20	30.50	32.03	6 to 8
67	Pear ... ..	147.26	114.80	32.46	22.47	114.80	36.60	31.88	7 .. 8
68	Lime ... ..	127.94	70.00	57.94	45.31	70.00	22.30	31.85	—
69	Lilac ... ..	94.42	60.60	33.82	35.82	60.60	19.30	31.84	8 to 10
70	Bignonia ... ..	68.63	51.70	16.93	24.67	51.70	16.20	31.33	ditto
71	Poplar (trunk)... ..	47.11	25.70	21.41	45.45	25.70	8.00	31.12	15
72	Wild chestnut... ..	116.16	62.20	53.96	46.45	62.20	19.20	30.86	20 to 30

If Nos. 15 and 16 are compared with No. 71, it will be seen that equal quantities of wood from various parts of the same tree give unequal quantities of charcoal. The leaves and roots of the poplar-tree yield 40.95 and 40.90 per cent. of charcoal respectively, whilst the trunk only yields 31.12 per cent. In another experiment, with cherry-wood, Violette found that the leaves and the root had the same chemical composition as the wood from the trunk, but yielded 50 per cent. less charcoal. From this it follows that not only are all kinds of plants not suitable for the manufacture of charcoal for making gunpowder, but also that not all parts of suitable plants. The wood, or, properly speaking, the perfectly formed fibre of the tree lying under the bark, bast and sap, has proved to be the most suitable. Wood for making charcoal must be cut in full sap—that is, in spring—and it is generally supplied to powder factories with the bark removed.

As previously mentioned, the yield of charcoal diminishes with the increase of temperature. Violette dried various pieces of dogwood of as nearly as possible equal age at 150° C., and

subsequently charred them. Up to 350° C. the charring was done by superheated steam. At higher temperatures it was done in a wind furnace, and finally in a smith's fire.

The results are contained in the following tables:—

Number.	DRYING.				CHARRING.				
	Weight of the wood before drying.	Weight of the wood after drying.	Loss.		Temperature of charring.	Weight of the wood dried at 150° C.		Quantity of gaseous products obtained from 100 parts of wood.	Quantity of charcoal obtained from 100 parts of wood. <sup>1</sup>
			Off the weight of the dried wood.	Per cent.		Before charring.	After charring.		
0	—	—	—	—	150	114·50	114·50	0·00	100·00
1	129·56	110·00	19·53	15·00	160	110·00	107·81	2·00	98·00
2	126·40	104·70	21·70	17·17	170	104·70	99·00	5·45	94·55
3	122·38	105·20	17·18	14·04	180	105·20	93·20	11·41	88·59
4	123·20	105·50	17·70	14·36	190	105·50	86·50	18·01	81·99
5	120·92	107·00	13·92	17·28	200	107·00	82·50	22·90	77·10
6	127·29	107·60	19·69	15·40	210	107·60	78·70	26·86	73·14
7	123·52	104·00	19·52	15·80	220	104·00	70·20	32·50	67·50
8	112·87	98·50	14·37	12·73	230	98·50	54·50	44·63	55·37
9	126·40	106·70	19·70	15·58	240	106·70	54·20	49·21	50·79
10	125·18	108·70	16·48	13·16	250	108·70	54·00	51·33	49·67
11	138·20	117·80	20·40	14·76	260	117·80	47·40	59·77	40·23
12	121·49	105·80	15·69	12·91	270	105·80	39·30	62·86	37·14
13	130·03	110·60	19·43	14·94	280 <sup>2</sup>	110·60	40·00	63·84	36·16
14	128·55	110·00	18·55	14·43	290	110·00	37·50	65·91	34·09
15	125·12	108·00	17·12	13·69	300	108·00	36·30	66·39	33·61
16	115·83	101·30	14·53	12·54	310	101·30	33·30	67·13	32·87
17	113·52	99·30	14·22	12·52	320	99·30	32·00	67·77	32·23
18	122·20	104·50	17·70	14·48	330	104·50	33·20	68·23	31·77
19	129·64	111·00	18·64	14·38	340 <sup>3</sup>	111·00	35·00	68·47	31·53
20	125·55	104·50	21·05	16·37	350	104·50	31·00	70·34	29·66
21	103·95	90·45	13·50	12·98	432 <sup>a</sup>	90·45	17·07	81·13	18·87
22	51·10	44·00	7·10	13·90	1023 <sup>b</sup>	44·00	7·50	81·25	18·75
23	80·14	69·00	11·14	13·90	1100 <sup>c</sup>	69·00	12·70	81·60	18·40
24	45·26	39·00	6·26	13·84	1250 <sup>d</sup>	39·00	7·00	82·06	17·94
25	73·75	63·00	10·75	14·60	1300 <sup>e</sup>	63·00	11·00	82·54	17·46
26	96·69	82·60	14·09	14·60	1500 <sup>f</sup>	82·60	14·30	82·69	17·31
27	46·82	40·00	6·82	14·60	Melting-point of platinum.	40·00	6·90	85·00	15·00

<sup>1</sup> Violette gives the name of charcoal to those products which were obtained by heating at any temperature. With each experiment the same kind of wood dried at 150° C. was charred. All charcoals from No. 1 to No. 10 were imperfectly charred.

<sup>2</sup> Red charcoal, the point where charcoal begins to be formed.

<sup>3</sup> Very black charcoal; also those following.

<sup>a</sup> melting-point of antimony.

<sup>b</sup> melting-point of silver.

<sup>c</sup> " " copper.

<sup>d</sup> " " gold.

<sup>e</sup> " " steel.

<sup>f</sup> " " iron.

It will be seen that the yield between 280° and 1500° C. was from 36 to 15 per cent. The quantity of volatile substances given off from the wood also diminishes with the increase of temperature. This is explained by the fact that on charring a

real separation of the carbon from the gases formed in the wood takes place, but without that separation being a complete one. A part of the carbon combines with a certain quantity of gas and remains in the still, while another part escapes with the rest of the gaseous products. The following table of Violette shows this phenomenon in a striking manner by giving on the one side the composition of the charcoal obtained, and on the other that of the volatilized bodies driven off on charring 100 parts of dogwood that has been previously dried at 150° C.

TEMPERATURE OF CHARRING.  Degrees C.	PRODUCTS OF THE DECOMPOSITION OF THE WOOD BY CHARRING.					TOTAL OF PRODUCTS.
	Solid matter or charcoal residue in the still per cent.			Volatilized matter per cent.		
	Carbon.	Gas. <sup>1</sup>	Ashes.	Carbon.	Gas.	
150	47·51	52·41	0·08	—	—	100
160	46·66	51·26	0·08	0·85	1·15	100
170	45·18	49·28	0·09	2·33	3·12	100
180	43·36	45·12	0·11	4·15	7·26	100
190	41·50	40·31	0·18	6·01	12·00	100
200	39·95	36·97	0·18	7·56	15·34	100
210	36·03	36·96	0·15	8·48	18·38	100
220	36·83	30·51	0·16	10·68	21·82	100
230	31·64	23·56	0·17	15·87	28·76	100
240	32·14	18·39	0·26	16·37	32·84	100
250	32·58	16·78	0·31	14·93	35·40	100
260	27·31	12·69	0·23	20·20	39·57	100
270	26·17	10·65	0·32	21·34	41·52	100
280	26·27	9·68	0·21	21·24	42·60	100
290	24·71	9·17	0·21	22·80	43·11	100
300	24·62	8·80	0·19	22·89	43·50	100
310	24·20	8·43	0·24	23·31	43·82	100
320	23·71	8·35	0·17	23·80	43·97	100
330	23·37	8·25	0·15	24·14	44·09	100
340	23·71	7·68	0·14	23·80	44·67	100
350	22·73	6·75	0·18	24·78	45·56	100
432	15·40	3·25	0·22	32·11	49·02	100
1023	15·37	3·12	0·30	32·10	49·11	100
1100	15·32	2·86	0·22	32·19	49·41	100
1250	15·81	1·91	0·22	31·70	50·36	100
1300	15·86	1·40	0·20	31·65	50·89	100
1500	16·37	0·83	0·11	31·14	51·55	100
over 1500	14·48	0·23	0·29	33·03	51·97	100

<sup>1</sup> Violette does not specify the nature of the gas. Hydrogen, oxygen, and nitrogen, and compounds of the same with each other and with carbon are understood.

The quantity of carbon in the various charcoals obtained is as varying as the yield of charcoal, as will be seen from the following table of Violette's:—

Number.	TEMPERATURE OF CHARRING. Degrees C.	ELEMENTARY CONSTITUENTS FOUND IN 100 PARTS OF DOGWOOD CHARCOAL.				NOTES.
		Carbon.	Hydrogen.	Oxygen, nitrogen, and loss.	Ash.	
1	150	47.5105	6.1200	46.290	0.080	Violette gives the general name of charcoal to all products obtained by heating at any temperature. All these charcoals are imperfect, either still wood, or not completely burned.
2	160	47.6055	6.0645	46.271	0.085	
3	170	47.775	6.195	45.9535	0.098	
4	180	48.936	5.840	45.123	0.117	
5	190	50.6145	5.115	44.0625	0.2215	
6	200	51.817	3.9945	43.976	0.2265	
7	210	53.3735	4.903	41.538	0.200	
8	220	54.570	4.1505	41.3935	0.217	
9	230	57.1465	5.508	37.047	0.3145	
10	240	61.307	5.507	32.7055	0.515	
11	250	65.5875	4.810	28.967	0.632	
12	260	67.8905	5.038	26.4935	0.5595	
13	270	70.4535	4.4615	24.192	0.8555	Very brownish-red charcoal, beginning to be friable. Highly suitable for sporting powder.
14	280	72.6395	4.705	22.0975	0.568	
15	290	72.494	4.981	21.929	0.610	Decreasing series of red-brown charcoal going into black.
16	300	73.236	4.254	21.962	0.569	
17	310	73.633	3.8295	21.8125	0.744	
18	320	73.5735	4.8305	21.086	0.5185	
19	330	73.5515	4.626	21.333	0.4765	
20	340	75.202	4.4065	19.962	0.4775	
21	350	76.644	4.136	18.4415	0.613	Very black charcoal, as also the following. Suitable for military powder.
22	432*	81.6435	1.961	15.2455	1.1625	
23	1023 <sup>b</sup>	81.9945	2.2975	14.1485	1.5975	Melting-point— * of antimony. b ,, silver. c ,, copper. d ,, gold. e ,, steel. f ,, iron. g ,, platinum.
24	1100*	83.2925	1.702	13.7935	1.2245	
25	1250 <sup>d</sup>	88.1385	1.415	9.2595	1.199	
26	1300*	90.811	1.5835	6.4895	1.1515	
27	1500 <sup>f</sup>	94.566	0.7395	3.8405	0.664	
28	over 1500 <sup>g</sup>	96.517	0.6215	0.936	1.9453	

According to this table the percentage of carbon in charcoal is proportional to the temperature at which it is made, or, in other words, the higher the temperature the larger the diminution in weight, but at the same time the larger the percentage of carbon in the residue. The duration of the charring has as large an influence on the yield of charcoal as the temperature. If wood is charred as slowly as possible, then the yield becomes much larger, whereas with quick charring just the opposite takes place (Violette).

The percentage of carbon increases with the yield. Thus the various kinds of dogwood mentioned on the opposite page gave on slow charring 82.106 per cent. of carbon, and 2.169 per cent. of hydrogen, whereas on rapid charring only 79.589 per cent. of carbon and 2.169 per cent. of hydrogen were found.

In describing the physical properties of charcoal in relation

METHOD OF CHARRING.	Temperature of Charring. Degrees C.	WEIGHT OF THE WOOD DRIED AT 150° C.		Quantity of volatile matter obtained from 100 parts of wood.	Quantity of charcoal obtained from 100 parts of wood.
		Before Charring. Grammes.	After Charring. Grammes.		
Slow ... ..	432	90.45	17.07	81.13	18.87
Quick ... ..	432	69.72	6.25	91.04	8.96

to the temperature at which it has been produced, its exterior state has first to be considered. Charcoal made at 270° C. (the products from wood heated below this temperature are not considered as charcoal) is of a brownish-red colour, and slightly friable. Charcoal made at a temperature above 280° C. has a dark colour, and at 340° C. it begins to be black. Charcoal made at this and higher temperatures is called black charcoal. If a temperature of 432° C. has not been much exceeded in making it, it can be easily pulverized. It has a smooth fracture showing the texture of the wood, many radial cracks, but no longitudinal ones.

Charcoal made at temperatures between 1000° and 1500° C. is very black, hard, and not friable, while charcoal made at the temperature of melting platinum is deep black, can only be broken with difficulty, and rings with a metallic sound when struck. If charring has been done rapidly, say at 432° C., the charcoal produced is very hard, very completely burnt, and is sonorous, whereas with slow charring the reverse is the case.

A further physical property of charcoal, which varies with the temperature of charring, is its density. Violette's researches in this direction are very interesting. He determined the specific gravity of dogwood charcoals made at various temperatures by weighing the pieces first in air and then in water. In order to completely drive out all air from the pores of the samples, they were allowed to soak for a week in water between the two weighings. He obtained the following results—

Charring temperature. Degrees C.	Specific gravity of charcoal.	Charring temperature. Degrees C.	Specific gravity of charcoal.
150	1.507	310	1.422
170	1.490	330	1.428
190	1.470	350	1.500
210	1.457	440	1.709
230	1.416	1025	1.841
250	1.413	1250	1.862
270	1.422	1500	1.869
290	1.406	Melting-point of the crucible.	2.002

On heating to 150° C. the wood remained unaltered. The product showed, therefore, a specific gravity corresponding to that of the wood, but it decreased as the charring process continued until, at a temperature of 290° C., it reached its minimum. At this temperature the wood is transformed into red charcoal, which is of low specific gravity throughout. At 350° C. the specific gravity is the same as that of the original wood. At this temperature the charcoal formed is black; above this temperature the specific gravity constantly increases until it reaches the value of 2.

The hygroscopic properties of charcoal have a different connection with the charring temperature. According to Violette's experiments, the quantity of water absorbed by dogwood charcoal exposed to moist air is smaller in proportion the greater the temperature at which it was charred.

Temperature of charring. Degrees C.	Quantity of water absorbed by 100 parts of charcoal.	Temperature of charring. Degrees C.	Quantity of water absorbed by 100 parts of charcoal.
150	30.262	290	6.920
160	18.420	300	7.608
170	18.120	310	7.300
180	16.680	320	5.554
190	11.636	330	4.504
200	10.018	340	5.904
210	9.742	350	5.264
220	8.304	440	4.704
230	8.200	1023	4.676
240	8.688	1100	4.444
250	7.888	1230	4.760
260	8.088	1300	3.224
270	8.288	1300	3.224
280	7.722		

It must be remembered that powdered charcoal absorbs about twice as much water as charcoal in lumps. This is readily explained by the greater free surface of powdered charcoal.

These experiments are not quite exact, since Violette, when calculating the percentage of moisture, omitted to deduct the amount of gases absorbed in the meantime by the charcoal. Nevertheless the principle is unaltered by this omission.

Finally, the thermal conductivity of charcoal requires mention. It increases with the temperature of charring. For low temperatures it is insignificant, and varies little with charcoal that has been made between 100° and 300° C., but it increases rapidly with



those made at a higher temperature, and ultimately reaches a value equal to two-thirds of that of iron (Violette).

Amongst the chemical properties of charcoal, which vary with the temperature of charring, solubility, inflammability, and liability to decomposition are the most important.

Charcoal made at 270° C. is almost entirely soluble in potassium or sodium solution. The solubility decreases rapidly as the charring temperature is greater, and finally charcoal made at 340° C. and upwards is insoluble.

The most inflammable charcoal—that made from willow fungus—takes fire spontaneously at 300° C. Charcoal made from other woods prepared at a constant temperature of 300° C. ignites, according to Violette, between 360° and 380° C. The ignition takes place at very varying temperatures, and, broadly speaking, the higher the temperature at which the charcoal has been made the higher its point of ignition.

## TEMPERATURE OF CHARRING.

260° to 280°,  
290° to 350°,  
432°,  
1000° to 1500°,  
melting-point of platinum.

## TEMPERATURE OF IGNITION.

340° to 360°,  
360° to 370°,  
about 400°,  
600° to 800°,  
about 1250°.

Charcoal, if mixed with sulphur, ignites at a much lower temperature than without it. Charcoal made at a temperature between 270° and 400°, if mixed with sulphur, ignites at 250°, and burns completely. If, on the other hand, charcoal made between 1000° and 1500° is mixed with sulphur and heated to 250°, then the sulphur only burns away and the charcoal remains unaltered (Violette).

The capacity of charcoal to decompose saltpetre varies in the same way as its inflammability, and is influenced by the temperature at which the charcoal has been made. Charcoal made between 270° and 432° decomposes saltpetre at 400°, but charcoal made between 1000° and 1500° only decomposes it at a red heat.

After these general introductory remarks, we may pass to consider the process as in practical use for charring wood. It is done either in heaps, pits, furnaces, coppers, or cylinders. In former times charring in heaps was the sole process, but this method has been almost completely abandoned for black powder purposes, as it was found that the charcoal so made was frequently contaminated with sand, earth, etc., from the covering of the

heaps, and also because it was difficult to obtain the uniform charring of the whole mass that is necessary for this purpose. The use of pits and brick-kilns for making black powder charcoal is now very rarely resorted to. The former method is only used in Spain for charring hemp stalks. In some places in Germany charring in "coppers" is still carried on. The "coppers" are cast-iron hemispherical pans 4 feet diameter and about 3 feet deep. They are buried in the ground to the upper flange. A few handfuls of lighted wood are thrown into them, and covered by gradually adding fresh wood in order to stifle the flame as much as possible without extinguishing it altogether. When the "copper" is filled, it is covered with a cast-iron cover pierced by a few small openings, through which the volatile products escape.

According to Violette, charcoal made in coppers has a different composition to that made by the ordinary method. Red charcoal with 73 per cent. of carbon and black charcoal with 83 per cent. of carbon, are obtained in them. The charcoal from the middle of the still is richer in carbon than that from the bottom or near the surface.

The process used in Denmark is intermediate between charring in kilns and in cylinders. The Danish charcoal is made from alder-wood, in special iron charring-boxes, which are placed in a three-storied kiln, the wood having been previously exposed to the air in an open shed for a long period. Each of the boxes is charged with from 13 to 15 lbs. of wood, and between  $3\frac{1}{2}$  and 4 lbs. of charcoal, or 25 per cent., are obtained from each. The charring lasts an hour, and is stopped when a blue flame comes out of the openings provided for the purpose. The charcoal is then placed in an air-tight room, in which it remains for 18 to 24 hours. It is sorted before use, all knots and burnt parts being picked out.

Since this method has all the defects of charring in cylinders, we will refer to them later on.

Charring in cylinders was invented by an Englishman, Bishop Landloff, and adopted in England in 1797. The process was at first kept secret until 1802, when Collmann's description of the method of charring in cylinders as practised in England made it generally known.

There are two kinds of charring cylinders—fixed and movable. The earliest fixed cylinders were of about the same construction as the cylinder furnace at Le Bouchet, which is illustrated in

Figs. 15 and 16. Two wrought-iron cylinders, 2 metres long, 0·67 metre wide, and 0·025 metre thick, are placed horizontally in pairs, and rest on their ends in an ordinary fire. As may be seen from the illustration, the hot gases rise between the two cylinders (A), surround them, and pass out through a flue below. On the side facing the fire, the cylinders are covered with clay, to protect them from burning through too quickly, and to ensure a more uniform heating. They are closed at both ends with covers, of which the front one is movable. The back cover (B) has four tubes of 10 centimetres diameter, three of which are for withdrawing samples. Into the fourth (o) a copper pipe (p) is inserted, which carries off the volatile products to the collector (c), where they are partly condensed, the rest escaping to the chimney.

In other places each cylinder is bricked in separately, and has

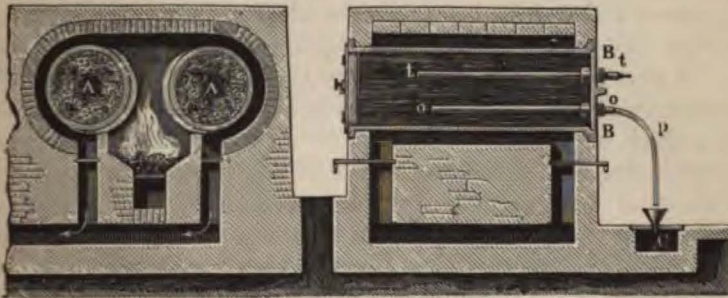

FIG. 15.—One-60th full size.

FIG. 16.—One-60th full size.

a sheet-iron baffle-plate standing about an inch away from the cylinder, and fixed over its lower side to protect it from the flame. The space between the cylinder and the baffle-plate is filled in with a mixture of cinders and clay. More recently cooling-worms have been used for the condensation of the vapours.

At Waltham Abbey a form intermediate between fixed and movable cylinders is used. It consists of a cast-iron cylinder bricked into a furnace, and provided with a tightly-fitting cover. The wood is packed in wrought-iron cylinders of about 3 feet 4 inches long and 2 feet 4 inches diameter, closed with lids, and the cylinders are placed in the stills. These separate charring cylinders are withdrawn from the furnaces by means of a pulley-block, and are taken on a truck into the cooling-room.

In most black powder factories movable cylinders are now used. The advantage of this system is that instead of charcoal having

to be removed from the stills in an incandescent state and put into the cooling vessels, it can be cooled in tightly-closed cylinders for any length of time, whereby contact with air and the consequent danger of the charcoal taking fire, which it is otherwise very liable to do, is avoided.

Fig. 17 shows a charcoal plant with movable cylinders as introduced by Maurouard at Metz; it is also used with small differences of detail at many other factories. The cylinders (H) are about 4 feet 6 inches long and 2 feet 4 inches diameter. They are run into the furnaces on the pulleys (E) along T-irons riveted to their lower side. The cylinders are made of two sheets of iron, the lower one being  $\frac{1}{4}$  inch thick, and the upper one  $\frac{1}{8}$  inch thick, fastened to angle iron rings (h). The back end is firmly riveted on, whilst the front end is movable, and has a small door ( $h_2$ ) through which the process of charring can be watched. A semi-cylindrical tube ( $h_4$ ) carries the products of distillation through the opening ( $h_3$ ) at the back end of the main gas-flue (i). A zinc rod (m) is inserted into the interior of this cylinder through the front cover, and is connected by levers with a pointer ( $m_2$ ), which, as the rod expands, shows on a scale ( $m_4$ ) the amount of expansion. At Spandau the rod of this pyrometric apparatus is made of bronze. The volatile products of distillation are carried into the fire by means of branch pipes ( $i_3$  and  $i_4$ ), while the condensed products pass through the branch pipe ( $i_4$ ) into a collecting vessel ( $i_{10}$ ). The opening of the retort is tightly closed by means of the door (G).

In the gunpowder factory of Sévran-Livry, the pyrometers are left out, and in place of them taps are fixed to the gas exit tubes, by means of which the end of the operation can be judged from the colour of the burning gas.

In some English factories vertical movable cylinders are used. They have the advantage that a large number can be fired at the same time, and that the cylinders can be lifted in a very simple manner by means of blocks and falls suspended from the ceiling, and passed on to the cooling-room. Their disadvantage is the larger pressure on the surface of the charcoal, due to the weight of the charge.

In nearly all countries the charging of the cylinders and the subsequent steps in the process of charring are almost identical. In cylinders that are bricked in, the front and back part rest on the walls, and in charging, these parts are left free, since they are not touched by the flame. The rest of the space is completely

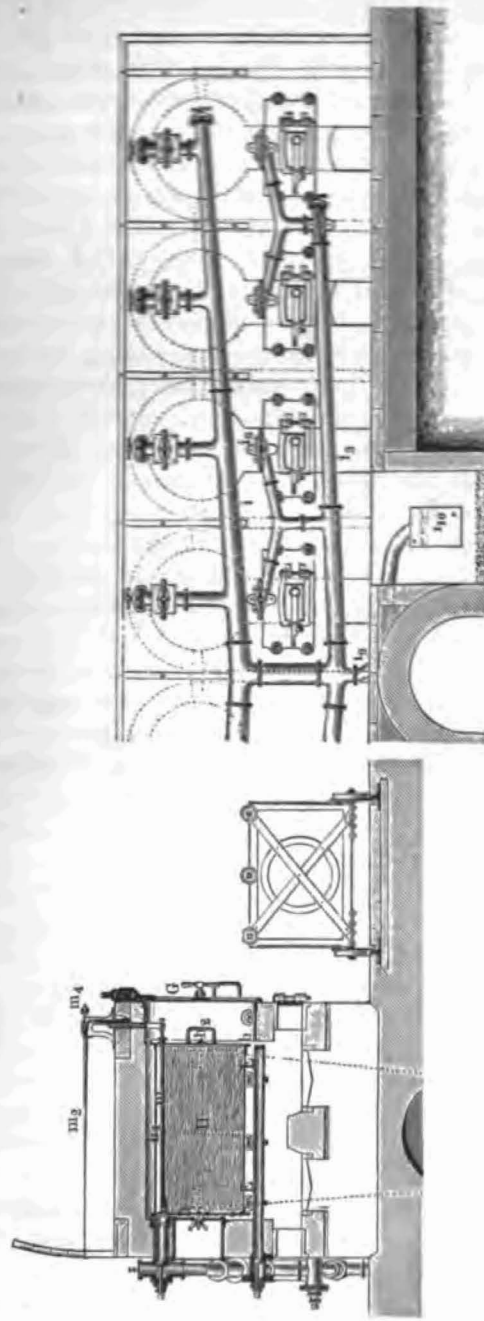

FIG. 17.—One-60th full size.

filled, and only a small space is left on the upper part to give room for the gases developed. The wood is charged either in single sticks or bundles tied together with straw rope. In the latter case the bundles are put into the cylinder, the straw rope is opened and taken out, and should any cavities be left, as much wood is added by hand as can be pushed in without using force. The front covers are then put on, and the joints smeared with clay, or any other fire-proof luting. The charring can then be started. Charcoal broken small or peat is used as fuel, the latter being preferable, because it gives a more uniform heat than charcoal. At the commencement the firing is done slowly, and at the front of the grate only. After about half-an-hour a whitish steam issues from the gas-pipe, part of the fire is then pushed back on the grate, and more coal added all over. As far as possible the production of flame is avoided, and in no case must the flame reach the cylinders. The distillation proper begins about  $4\frac{1}{2}$  or 5 hours after starting the fire. The white smoke becomes more yellow, and smells strongly empyreumatic. Where test sticks are used, one of them is drawn out and broken in several places, to see in which place charring is delayed, and the fire is then pushed along the grate towards that part of the cylinder. The gases now gradually change to white again, and finally to blue. In many factories the blue colour is taken as a sign that the charring is completed; in other factories, where the gases of distillation are led into the fire, the burning gas is the guide.

In Dresden, special attention is devoted to the gas exit pipe. If its angle-piece is cold enough to be touched, no more fuel must be added, but the fire is left another quarter of an hour under the cylinders, and then drawn, the flue-dampers being shut so that the charcoal can cool. At Spandau the charcoal remains in the cylinders for an hour, whilst at Dresden it is allowed to cool in them from sixteen to twenty-four hours, according to the state of the weather. The time of charring is also different; in some places it is from six to seven hours, in others from eleven to twelve hours. No fixed rule can be given for this, as it depends very much upon the temperature employed and on the kind of charcoal being made. If charcoal for sporting powder is to be made, the fire is so regulated that the time of charring is at least eleven hours.

When the time prescribed for cooling is over, the cylinder is emptied and the charcoal rapidly introduced into cylindrical

iron vessels, which are provided with tightly-fitting lids, in which it is allowed to remain until it is required for pulverizing. In no case must the latter be done before the lapse of four days.

In Dresden the charcoal is put in thin layers on wooden shelves as it comes from the cylinders, and allowed to lie on these exposed to the air, but not exposed to the direct rays of the sun, for forty-eight hours. It is then sorted, weighed, and put into iron cylinders, which can be tightly closed by means of a lid. In 1791 instructions were given in the French factories for quenching the charcoal with water in order to hasten the manufacture, but as Robins' experiments showed that powder made from charcoal so treated was inferior, quenching was prohibited in 1798.

With the process of charring in fixed cylinders, Kahl obtained at the Dresden gunpowder factory from air-dry dogwood containing 11·57 per cent. of moisture, a total yield of 26·429 to 28·674 per cent.—*i. e.* an average yield of 27·4 per cent. of charcoal. With alder-wood containing 11·7 per cent. of moisture the yield was 26·2 per cent. This yield does not at all represent a uniform product, since red charcoal is always formed side by side with black, and it may amount to one-third of the total yield, as is shown by the following experiment made by Violette at Esquerdes with dogwood containing between 10 and 12 per cent. of moisture. The table shows also the consumption of wood for firing the cylinders. All figures refer to 100 parts by weight of wood used for charring.

YEAR.	WOOD USED FOR FIRING.	YIELD.		
		Red charcoal.	Black charcoal.	Total.
1843	65·2	12·79	20·12	32·91
1844	77·0	16·39	14·89	31·28
1845	75·7	15·47	16·00	31·47
1846	93·8	12·07	20·25	32·32
Average	74·2	14·18	17·81	31·99

The production of red charcoal side by side with the black variety is explained by the simple fact that the heat in the cylinders is not uniform throughout, and therefore the charcoal taken from various parts of the cylinders must be different in composition. This is conclusively shown in the following analysis by Kahl—

REMARKS.	COMPOSITION.			
	Carbon.	Hydrogen.	Oxygen.	Ash.
Charcoal taken from the front and the top of the cylinder. Temperature of charring low.	83.88	3.24	11.56	1.33
	85.36	3.82	9.21	1.61
	83.43	3.30	11.80	1.47
	79.22	3.29	16.24	1.25
	77.83	2.71	18.21	1.55
Charcoal from the centre of the cylinder.	90.39	2.51	5.49	1.61
	91.08	2.69	4.58	1.65
Charcoal from the back and the lower part of the cylinder. Charring temperature the highest.	90.27	2.18	6.14	1.41
	91.10	1.97	5.06	1.87
	92.24	2.03	3.85	1.88

Supposing the charcoal taken from different parts of the cylinder were mixed together, the resulting product would still be different from that of other black powder factories where it has been treated in the same manner. The following table shows this, in which the average composition of red charcoal from various black powder factories is given:—

COMPOSITION OF THE CHARCOAL.				PLACE OF THE POWDER FACTORY.	FOR SPORTING POWDER.
Carbon.	Hydrogen.	Oxygen, Hydrogen, and loss.	Ash.		
71.1805	2.521	25.9855	0.3085	Bouchet	extra fine fine
74.011	2.6465	22.3475	0.513		
70.3765	2.655	26.4955	0.4815	Angoulême	—
72.090	4.341	22.7105	0.873		
75.664	3.382	20.2225	0.7855	Esquerdes	extra fine fine

Freshly-made charcoal has the capacity of absorbing moisture and of condensing gases on its surface in a high degree. Kahl investigated this with dogwood charcoal made in cylinders. In very dry weather it absorbed  $7\frac{1}{2}$  per cent., and in very moist weather 10 per cent. of its weight of steam and gases in from two to four days. The steam is again given off completely on subsequent drying, but the gas only partially. Thus, fresh charcoal which had absorbed on exposure to air 6.98 per cent. of gases and moisture, lost in a current of dry air at 150° C. 4.85 per cent. of water on an average, and retained therefore in its pores 2.13 per cent. of gases, taking up at the same time another 0.69 per cent. of gases, probably from the hot air. The charcoal dried at 150° C.



thus still contained 2·82 per cent. of gases, which moreover could not be entirely driven off, even at a temperature of 270° C.

Another point in connection with the condensation of gases on the surface of the charcoal is that on the contact of gases with the charcoal heat is always disengaged, and if this is rapid and violent, the temperature may rise to the ignition point of the charcoal. This occurs as a rule when freshly-prepared finely-ground charcoal is piled up in large quantities. However clear and simple the causes of such inflammation are, the circumstances accompanying it are far from simple, and frequently combine in such a manner as to give apparently contradictory results. To investigate the real cause of inflammation, a series of experiments were made with cylinder charcoal at the old Berlin gunpowder factory with the following results:—

Dogwood charcoal made at 28 per cent. yield ignites the more readily the shorter the time which elapses between the making of the charcoal and its storage in a pulverized state. Black strongly-burnt charcoal becomes hot and ignites more easily than a red and lightly-burnt one. Freshly-prepared and finely-divided charcoal in quantities of 132 lbs. only ignites spontaneously when it is stored in vessels at least 2 feet deep. The ignition almost always starts at the interior of the charcoal mass, and not on the surface.

In order to determine the rate of increase in weight and of temperature, 50 kilogrammes of charcoal were made at 28½ per cent. yield, and immediately after charring finely pulverized and placed in an uncovered cylindrical sheet-iron vessel on a scale. The following changes occurred:—

Time in hours.	Temperature of the charcoal in °C.	Increase of weight in grammes.	Time in hours.	Temperature of the charcoal in °C.	Increase of weight in grammes.
0	17·5	—	14	70·0	—
1	28·75	—	15	72·5	203
2	32·5	—	16	75	—
3	38·75	39	18	77·5	—
4	41·25	—	21	80	250
5	43·75	—	22	82·5	359
6	46·25	73	24	98·75	390
7	48·75	—	26	102·5	—
8	53·75	105	28	112·5	421
9	56·25	121	30	133·75	437
10	58·75	140	31	158·75	—
11	61·25	156	33	176·25	476
12	63·75	172	36	Inflammation.	—
13	67·5	—			

The increase of weight on ignition is therefore nearly 500 grammes, or about 1 per cent. Omitting moisture, only about 0·356 cubic metres of dry air are required for that. The heating takes place fairly regularly but slowly at the beginning, whereas, when approaching the point of ignition, it increases rapidly. A totally different result was obtained when the charcoal was not pulverized until eighteen hours after charring, and also when smaller quantities were experimented upon. The temperature of the room was from 5° to 8·5° C., and the temperature of the charcoal when weighed in the same room 18·75°.

	50 kg.	20 kg.	16 kg.	11 kg.	7·5 kg.	6·5 kg.	2·5 kg.	
Hours after filling in the charcoal into the vessels specified hereafter.	In a cylindrical iron vessel of metres	In a wooden drum of metres	In an oval tin of metres	In wooden drums of metres				
	0·67	0·59	0·35 and 0·57	0·38	0·336	0·344	0·234	
	DIAMETER.							
	The above-mentioned vessels were filled with charcoal up to a height of metres							
	0·59	0·468	0·468	0·417	0·365	0·313	0·261	
	TEMPERATURE OF THE CHARCOAL IN DEGREES C.							
	12	83·75	33·75	28·75	25	16·25	20	15
	15	91·25	31·25	26·25	23·75	15	20	13·75
	18	245	30	26·25	23·75	12·5	18·75	12·5
		Inflamed.						
21		30	26·25	21·25	12·5	18·75	12·5	
23		28·75	25	21·25	12·5	17·5	11·25	
48		17·5	13·75	13·75	11·25	13·75	11·25	
72		12·5	11·25	11·25	11·25	12·5	11·25	

However interesting these experiments are, no general conclusions can be drawn from them as to the real cause of the ignition, since the behaviour of the charcoal in this respect is very erratic, as is shown by the result of experiments recorded by Colonel Aubert. In these, two quantities of charcoal were treated in exactly the same way and at the same time in two equal vessels, with the result that one ignited, whilst the other did not. Hadfield even reports a case where charcoal in lumps, and three days old, ignited over-night after it had been carted

a distance of sixteen miles. He explains it by assuming that charcoal powder, in which the combustion started, was formed during the carting. Against this explanation may be set a case which happened in Saxony, where charcoal simply stored in pieces one above the other ignited. The spontaneous ignition therefore may be brought about by various circumstances, and it is still uncertain whether the various conditions of the atmosphere in relation to its pressure, temperature, hygrometric and electric state, influence the phenomenon. According to known results, they can have at least no absolutely direct action. It is rather to the varying capacity of charcoal for absorbing and condensing air, and the manner in which the heat liberated is retained by the substances, that we must look for the explanation. Davies thinks that the spontaneous ignition of charcoal is caused by the oxidation of potassium formed during charring from the potassium carbonate existing in all kinds of woods, and it is also the reason why no ignition takes place when charcoal is mixed with sulphur, since in the latter case no potassium sulphide is formed. On the other hand, it is most improbable that carbonate of potassium is reduced to potassium at the temperatures at which charcoal is made, since it is known that a white heat is required to effect the reduction. In direct opposition to this view are the many accidents which have happened whilst all three ingredients of gunpowder were being worked in stamp-mills simultaneously in an undivided state.

Finally, some experiments made by Kahl on the temperatures of ignition of cylinder charcoal in free air may be mentioned. They are interesting from the fact that the temperatures observed are different. Kahl found the temperature of spontaneous ignition to be  $360^{\circ}$ ,  $352^{\circ}$ ,  $342^{\circ}$ ,  $320^{\circ}$ ,  $325^{\circ}$ , or  $340^{\circ}$  on the average, with five different pieces of dogwood charcoal, two of which were hard and sonorous, two fairly soft, and one of average character. The temperature was determined in the following manner:—A test-tube was filled to about a third with charcoal and closed with a perforated cork, into which two glass tubes, bent at an angle, were fitted. One was short and the other long, and the longer reached down into the charcoal. The apparatus so prepared was dipped to about one-half its depth in a bath of molten metal, and a mercury thermometer placed close to the test-tube. As soon as the mercury began to rise a small quantity of air was drawn through the charcoal by means of an aspirator, this process being repeated at each increase of  $5^{\circ}$  of temperature,

and the lowest temperature at which ignition took place was noted. The temperatures of ignition for alder-wood were found to be 360°, 360°, 360°, 346°, 333°, or an average of 352°. In the first three experiments the charcoal did not ignite in the bath of molten metal at 355°, and a test-tube was therefore dipped in a bath of boiling mercury.

Violette introduced in Esquerdes a process for manufacturing charcoal in cylinders by means of superheated steam. His apparatus is illustrated in Figs. 18 and 19. It consists essentially

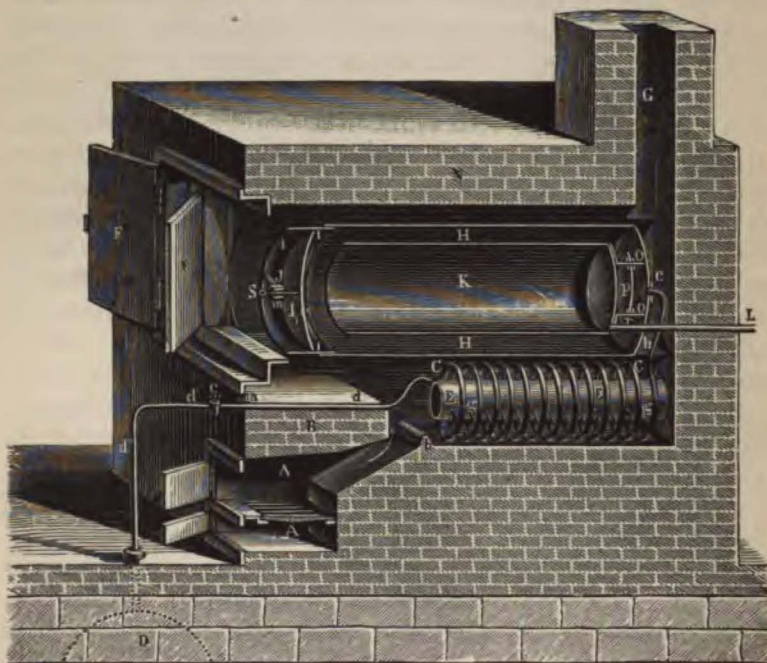

FIG. 18.—One-50th full size.

of two concentric wrought-iron cylinders (H and K), of which the outer cylinder (H) serves as a casing for the inner one, in which the wood is charred.

Underneath the cylinders is placed the spiral iron tube (c), one end of which is connected by means of a small tap (c) with the boiler supplying the steam. The spiral is heated by the fire (A), the grate is arched over, and a small bridge (b) causes the flame to be drawn towards the upper part of the coil. The internal diameter of the wrought-iron tube forming the coil (c)

is 20 millimetres, and the thickness of metal 5 millimetres, its total length being about 20 metres. At e it enters the outer cylinder (H). A drum (E), which is closed at both ends, is fixed in the centre of the spiral by means of small iron clamps (g); it prevents the flame passing directly along the centre of the coil, and forces it to play round the tube. The gas escapes through the chimney (G), and the end of the furnace opposite to the chimney is closed air-tight by means of two strong cast-iron doors (F), in order to prevent exterior cooling of the cylinders. The cylinder (H), the metal of which is 10 millimetres thick, rests on the wall (h),

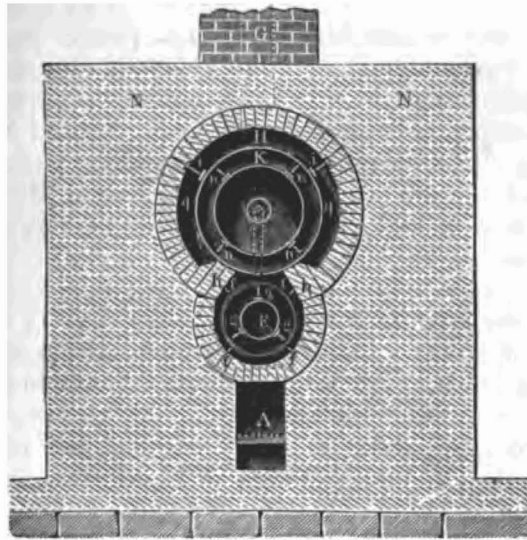

FIG. 19.—One-50th full size.

and is held by two iron partitions (i). These lie in a groove in the walls, and form channels for the circulation of the hot air coming from the fire (A). The cylinder (H) is closed on its back end, where the coil enters it, but at its front end it has a wide circular neck (I), against which the cover (J) rests. The inner cylinder (K), which is 5 millimetres thick, is closed at the back and open in front. It is supported by eight iron clamps (n), and has at the back four iron rods (o), which are provided with a circular disc (P), and serve to fix the cylinder (K) in the cylinder (H).

Each charge consists of from 25 to 30 kilogrammes of dogwood, and is placed in a perforated cylinder. The pieces must not be

too large. The perforated cylinder facilitates the filling and discharging of the furnaces, and is pushed into the cylinder (κ). The steam enters the space between the two cylinders, and from there passes through the open end of κ into the perforated cylinder holding the charge. After it has penetrated the interstices of the wood, charred it, and taken up the empyreumatic products, it either escapes into the air through the copper-pipe (L), which is fixed into the back of κ, or is condensed in some suitable manner.

As soon as the boiler is heated and the steam has reached the required pressure—from 7 to 15 lbs. per square inch—the fire for the coil (c) is lighted, and after a quarter of an hour the perforated cylinder charged with dogwood is pushed into κ. The disc (J) is luted on to the cylinder (H) with clay, and the two cast-iron doors are closed. In about ten minutes, when the clay will have become sufficiently dry, steam is admitted by opening the cock (c). After this the chief point requiring attention is the regulation of the fire (A), which must be done in such a manner that the steam is kept at as uniform a temperature as possible. To enable this to be done a small glass window (a) is provided, through which the fire can be watched. The temperature of the interior of the cylinder is estimated by the melting of suitable test pieces of metals or alloys, as the temperatures required for charring are too near the boiling-point of mercury to permit the use of mercurial thermometers. In Violette's arrangement two small copper tubes, closed at their inner end, pass through the brickwork into the inner cylinder, in which small cylinders of tin, lead, or some other suitable alloy melting at pre-determined temperatures are placed. In order that the melting may be visible from the outside, an iron pin loaded with a metal weight is put into the metal cylinders, which sinks into them as soon as they begin to melt. After some time the tin melts, and the steam indicates by its odour and colour that it contains the first products of distillation, and consequently that the charring has commenced. The steam next becomes thicker, and by and by its appearance alters. After two hours from the commencement of distillation the escaping steam is without smell, which shows that charring is at an end.

The apparatus must then be discharged at once, in order to prevent the red-brown charcoal being converted into the black variety by the heat concentrated in it. This would occur with three to four minutes' delay over the proper time required. To



discharge, the foreman shuts off steam at once, opens the cast-iron doors, and takes off the cover. In the meantime two men take the cooling vessel, which is a large wrought-iron cylinder of 0·55 metre diameter and 1·20 metres in height, and place it in a horizontal position in front of the opening of the outer cylinder, so that its opening is closed. The foreman puts a long iron bar through the tube (L), and, by means of it, pushes the perforated cylinder out into the cooling vessel. Immediately after emptying the cylinder is again charged with wood. The next charring progresses much more rapidly on account of the brickwork being already hot. Charring begins in a quarter of an hour, and the whole operation lasts only two hours, the first operation taking three hours. The succeeding operations take still less time, and the sixth one, which is as a rule the last for the day, takes only an hour and a half. In this way 50 kilogrammes of good charcoal are obtained in one day. The consumption of steam per hour is 20 kilogrammes at  $3\frac{3}{4}$  lbs. pressure (one quarter of an atmosphere), 25 kilogrammes at  $7\frac{1}{2}$  lbs. (half an atmosphere), and 45 kilogrammes at 15 lbs. (one atmosphere).

The daily consumption of coal is between 80 and 100 kilogrammes, according to the pressure of the steam. Fifteen to 20 kilogrammes of wood, or 5 to 6 kilogrammes of coke are required for heating the coil at each operation—that is, 150 to 200 kilogrammes of wood, or 60 to 80 kilogrammes of coke for each 100 kilogrammes of charcoal obtained. The results obtained with this apparatus at Esquerdes in July 1848, with dogwood containing between 10 and 12 per cent. of moisture, will be found on the next page.

The black powder made from such red charcoal gave, in trials with the ballistic pendulum, a larger muzzle velocity than the normal powder made from ordinary charcoal. The results are shown in the following table:—

	Fine sporting powder.	Superfine.	Extra fine.
From ordinary charcoal ...	330	350	375
From charcoal of Esquerdes	356·2	357·7	382·07

} metres  
per second.

According to Violette, if steam be heated to about 350° C., red charcoal of 70 per cent. and black charcoal of 85 per cent. of carbon are obtained. If at the same time the still and the coil are also heated, but to a temperature below 450° C., the wood is freed from

PRES- SURE IN ATMO- SPHERE	DURATION OF THE OPERATION.		QUANTITY IN KILOGRAMMES OF						RED- BROWN CHARCOAL OBTAINED FROM 100 PARTS OF WOOD.
			Coal consumed for the boiler.	Firewood consumed for each operation.	Dogwood used for charring.	Charcoal obtained.			
	hours.	minutes.				Red- brown.	Black.	Dead burnt.	
1	2	45	118	25	25	9·220	—	—	36·88
1	2	0		13	30	11·200	—	—	37·33
1	2	0		11	25	10·050	—	—	40·20
1	2	45		12	30	10·450	—	—	34·83
1	2	0	115	12	30	10·500	—	—	35·00
1	3	0		26	25	8·950	—	—	35·80
1	2	0		12	25	8·900	—	—	35·60
1	2	30		11	25	9·350	—	—	37·40
1	2	0	85	9	25	9·250	—	—	37·00
1	2	15		13	30	11·150	—	—	37·16
1	3	15		30	25	9·100	—	—	36·40
1	2	10		11	30	10·500	—	0·150	35·00
1	2	15	82	13	30	10·650	—	—	35·50
1	2	0		12	30	11·350	—	0·700	37·83
1	2	0		15	30	10·150	—	0·750	37·83
1	3	0		26	30	11·000	—	—	37·00
1	2	0	82	9	30	11·150	—	0·400	37·16
1	2	15		12	30	11·050	—	—	36·83
1	2	15		10	30	11·150	—	—	36·83

its volatile constituents as completely as if it had been heated in a crucible to 1200° C.

Violette's experimental results on this point are given in the following table:—

WEIGHT OF THE CHARCOAL EXAMINED.	YIELD PER CENT.	PERCENTAGE COMPOSITION.				NOTES.
		Carbon.	Hydrogen.	Oxygen, Nitrogen, and Loss.	Ash.	
0·567	28·18 to	76·808	2·738	19·929	0·529	} By heating very strongly the steam only.
0·455		77·135	3·900	18·440	0·549	
0·4545	19·09 to	89·939	2·684	5·852	1·540	} By simultaneously heating the steam and the still.
0·567		88·399	2·523	7·849	1·235	

In the latter case steam does not act more rapidly on account of the increase of temperature, because, according to Violette, the same result is obtained with a smaller quantity of fuel. It simply facilitates the escape of the volatile compounds just as hot air causes water to evaporate.

Wood was also charred by Violette's method at Wetteren, near Ghent. The apparatus used there was the same, except that it



had two charring cylinders, which could be used alternately or simultaneously. This process was also tried by Kahl at Dresden. The apparatus used was the same in principle as that constructed by Violette, excepting that the coil and the cylinders were not placed above each other but side by side, so that the flame did not come in contact with the cylinders all over. In order to protect the cylinders from a too rapid cooling, the space between the two was filled with pieces of pumice-stone. Near where the steam entered the charring cylinder through the coil, a thermometer or a pyrometer on the Breguet principle was inserted as required.

For the purpose of making black carbon Kahl introduced steam of 100° C. into the apparatus, and increased the temperature up to 280° during the first half-hour and up to the temperature of charring during the next three-quarters of an hour, at which point he kept it for two and a half hours. If the heating was done slowly, the charring process lasted much longer. Kahl obtained in this way a yield of 30.2 to 30.4 per cent. at 350° C. from air-dried dogwood containing 11.57 per cent. of moisture, and from dogwood containing 9 per cent. of moisture, a yield of 28.8 per cent. at 400° and 26.6 per cent. at 440°. The composition of the charcoal was the following:—

	Carbon.	Hydrogen.	Oxygen.	Ash.
Charcoal at 350° C. } " " 410° C. } " " 440° C. }	76.00 75.06 79.60 84.99	3.91 4.09 3.82 3.30	18.58 19.51 15.06 10.12	1.51 1.34 1.52 1.59

The temperature of ignition was found to be between 300° and 340° C. Air-dried alder-wood with 11.7 per cent. of moisture yielded 29.7 to 30.3 per cent. of black charcoal at 350° C., the temperature of ignition of which was between 337° and 357° C. All the charcoal was soft and friable, perfectly free from soot, and of uniform composition, as is shown by the analysis below. No. 1 is of charcoal taken from near the steam inlet, and No. 2 from near the steam exit.

No. 1.	No. 2.
82.95 Carbon.	82.91 Carbon.
3.10 Hydrogen.	3.26 Hydrogen.
12.28 Oxygen.	11.98 Oxygen.
1.67 Ash.	1.85 Ash.
100.00	100.00

As regards the yield of charcoal produced by superheated steam in cylinders, Violette's and Kahl's experiments show that this method gives a higher yield of red charcoal than the ordinary method of charring in cylinders. Since black charcoal is only used for the manufacture of military powder, whilst red charcoal is only used for fine sporting powders, Violette's method presents

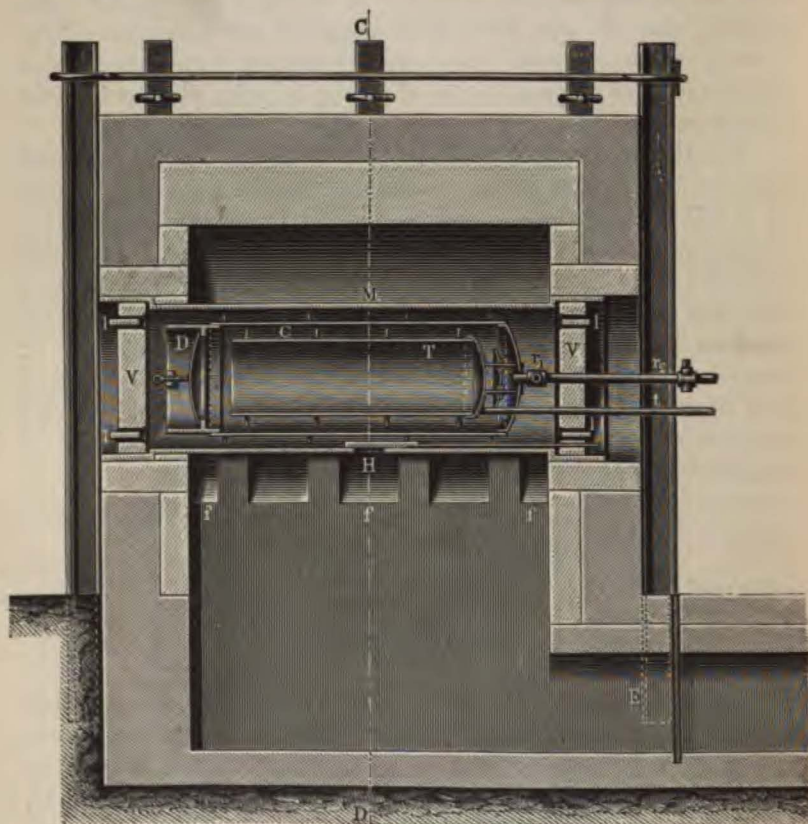

FIG. 20.—One-50th full size.

no advantage, as far as yield goes, over the old system of charring in cylinders, where military powder only is made. It must be owned, however, from the analysis mentioned that charcoal made by superheated steam is of perfectly uniform composition, which cannot be said of ordinary cylinder charcoal; but the unequal composition of the latter, if it does not vary within too wide limits, has no influence on the properties of the black powder,

because the charcoal from the various parts of the cylinder is well mixed, and hence a mixture of uniform average composition is obtained, which differs, so far as inflammability goes, very little from that of steam-made charcoal. It must be specially noted that the outlay for an apparatus of Violette's construction is much higher than that of the usual cylinder apparatus, and also that the coil is more easily burnt by the flame than cylinders

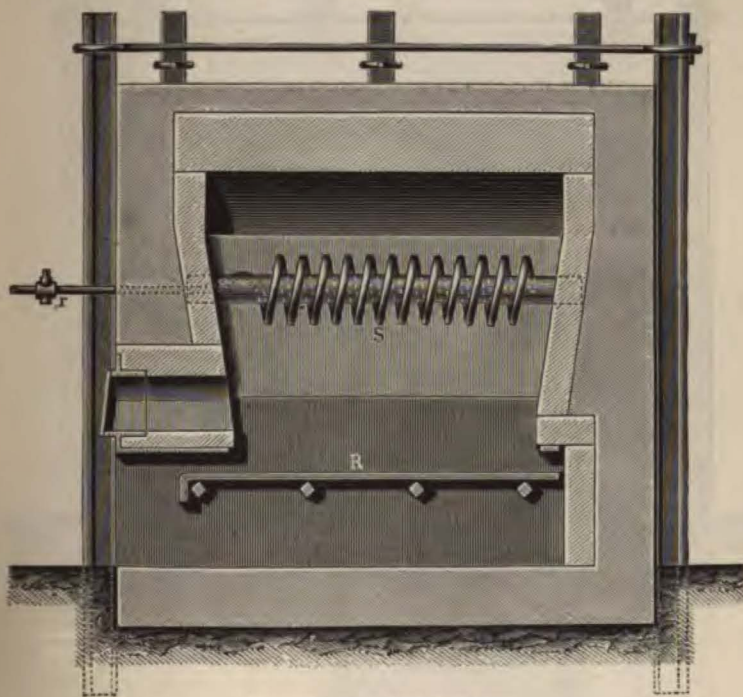

FIG. 21.—One-50th full size.

are. Again, no means have yet been found for utilizing the excess of heat, in order to counterbalance the greater expense.

These are the chief reasons which have hitherto prevented practical men from making use of an apparatus like that of Violette's. The Royal Gunpowder Factory at Dresden have abandoned the process for these reasons, and have returned to the usual method of charring in cylinders.

Hermann Güttler, of Reichenstein in Silesia, has invented and patented a process which is specially suited for charring wood



cuttings, wood pulp, straw, peat, hemp, flax, etc. It obviates the necessity of cooling the charcoal. With ordinary cooling vessels the loss of heat takes place slowly from outside to inside. The air, which is absorbed with great avidity during the cooling and subsequent storing of the charcoal, covers the single sticks with only a superficial layer of moisture, the inner being still unsaturated,

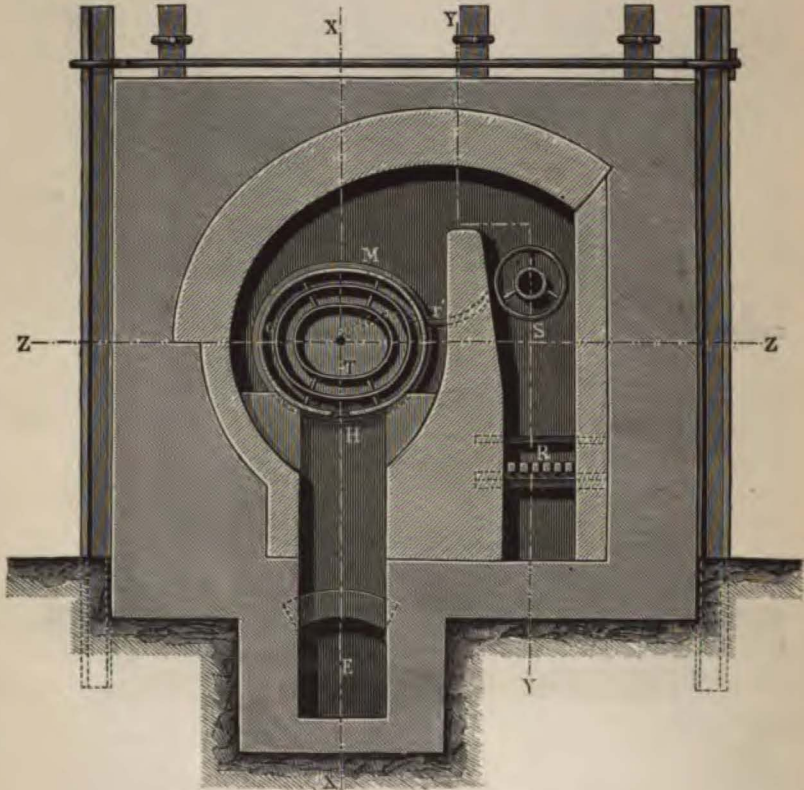

FIG. 22.—One-50th full size.

and this on grinding may cause ignition. In order to prevent this, Güttler effects the charring by means of hot carbonic acid. Practically he uses gases of combustion as free as possible from oxygen, and cools by introducing cold carbonic acid in the still. In this way it is possible to char uniformly and rapidly even powdered substances. The charcoal is further saturated with carbonic acid in its most absorbent state. It cannot, therefore,

rapidly absorb large quantities of air even on being crushed, and is thus protected from spontaneous ignition. The process also permits the production of charcoal with special pre-determined qualities, since the charring process can be interrupted without fear of ignition at any moment, and cold carbonic acid introduced.

Güttler's furnace is illustrated in Figs. 20, 21, 22, and 23. It has a muffle (M), a charring cylinder (C), and a coal-drum (T), in which a perforated drum is inserted for the convenience of charging. Both the charring cylinder (C) and the drum (T)

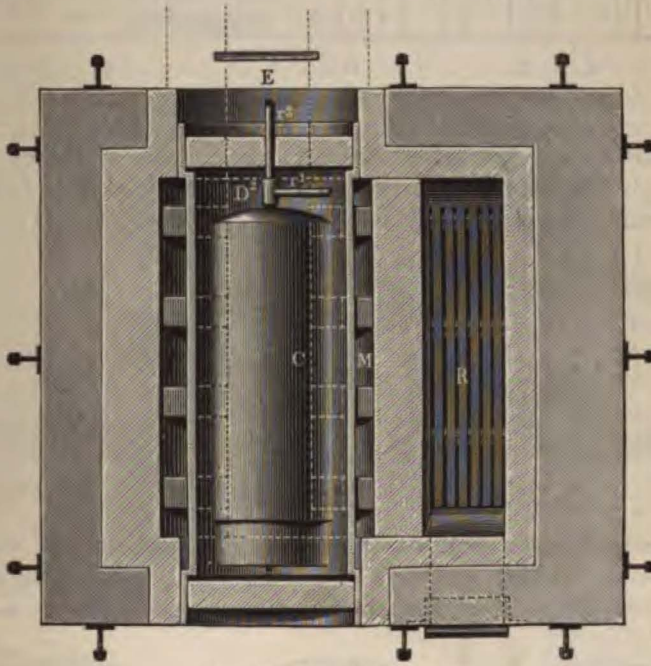

FIG. 23.—One-50th full size.

have ribs to keep them their proper distance apart. A super-heating apparatus in the form of a coil (S) is placed in the fire space (R), to which the gas to be heated is conducted by means of the pipe (r). The coil is connected with the charring cylinder (C) by means of the connecting-pipe (r<sub>1</sub>). The products of distillation escape, together with the gas used for charring, through the pipe (r<sub>2</sub>). The hot gases heat first the coil, then pass over the fire bridge (F) and the muffle (M), and escape through the flues (f<sub>1</sub>, f<sub>2</sub>, and f<sub>3</sub>) to the chimney (E). When the charring is finished,

the holes ( $l_1$ ) and ( $l_2$ ), etc., in the covers (v), are re-opened, so that cold air is drawn through the space between the muffle and the charring cylinder. At the same time the fire is drawn

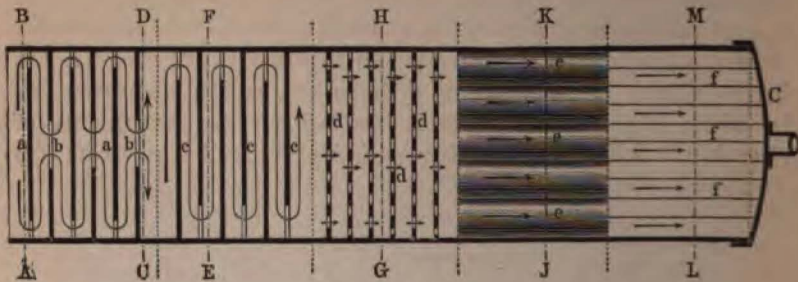

FIG. 24.

and the cooling gas introduced into the interior of the cylinder through the pipe ( $r_2$ ). Later on Güttler modified this furnace, by making the charring cylinder movable, so that it could at once

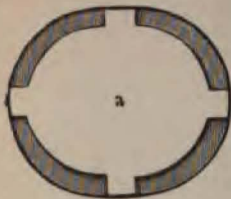

FIG. 25.

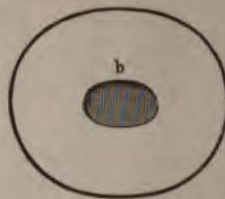

FIG. 26.

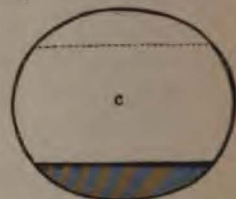

FIG. 27.

be charged again and easily cooled. He further put various sheet-iron division plates (Fig. 24) into the cylinder, so as to lengthen the path of the hot gas through the cylinder, and so

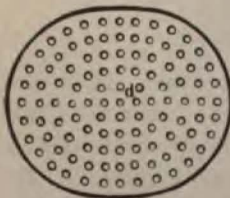

FIG. 28.

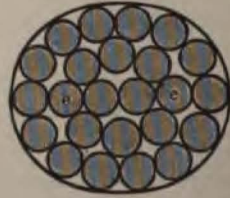

FIG. 29.



FIG. 30.

made it come into more intimate contact with the material to be treated. He also used the wood in the form of "wood-wool." The small additional cost of making is compensated for by the shorter

duration of charring. The divisions consist of perforated discs standing with their openings opposite to each other (Figs. 25, 26, and 27), or of cases which can also be made of perforated sheet-iron, wire-gauze, or similar material (Figs. 28, 29, and 30).

In his latest designs Güttler does not use a coil, but arranges a producer-furnace by the side of his charring furnace, in which he makes carbonic acid gas by blowing air through burning coke by means of a fan. The carbonic acid gas is then blown through a tube, fitted with a cock, into the charring cylinder. The author has personally satisfied himself of the excellent quality of the charcoal produced by this process.

The *yield* of charcoal depends essentially upon the kind of wood and the manner of charring employed. It has been shown above that the yield is in inverse proportion to the time of charring. In French factories the yield obtained is 30 per cent. of black charcoal from dogwood, 36 per cent. of black charcoal from soft woods, and 40 per cent. of red charcoal from dogwood. At Waltham Abbey a minimum of 25 per cent. of charcoal by weight is insisted upon.

The temperature of charring also influences the inflammability of charcoal, and hence its rate of combustion. The higher the temperature of charring the tougher the charcoal becomes, and under the same circumstances the powder made from it gives a lower muzzle velocity.

Charcoal made from straw for brown powder is an exception, as in spite of the lower temperature of charring, it does not give higher pressures.

The experiments shown in the following table were made at the Royal Gunpowder Factory, Waltham Abbey:—

		No. 1. Duration of charring 7 hours at a low heat.	No. 2. Duration of charring 4 hours at a higher heat.	No. 3. Duration of charring 3 hours at a very high heat.	No. 4. Duration of charring 3½ hours at a heat between those of No. 2 and No. 3.
		Per cent.	Per cent.	Per cent.	Per cent.
Analysis of the Charcoal.	Carbon ... ..	78·23	82·23	87·55	85·57
	Hydrogen ... ..	3·67	3·31	2·91	3·02
	Oxygen and traces of Nitrogen ...	16·96	13·19	8·29	10·09
	Ash ... ..	1·41	1·27	1·25	1·32
Muzzle velocity in feet—seconds		1417	1399	1353	1403
Pressure in tons per square inch	A ... ..	20·60	15·68	9·62	13·20
	B ... ..	15·66	12·76	9·66	11·68
	Projectile ... ..	14·22	12·18	7·25	10·46



The wood used for the manufacture of gunpowder varies in different countries. Dogwood (*rhamnus frangula*) is used as a rule for military powder, and also for sporting powder, and willow and alder-wood for blasting powder. The kind of wood that has been used can be seen by breaking an unfissured piece of the finished charcoal. Dogwood shows a tough fracture and a round brown pith, willow a round black one, alder-wood a triangular one, and hazel-wood a small round black one.

The thickness of the wood affects the charring process, and in consequence the inflammability of the charcoal. Thin branches are therefore used by preference, or if thicker ones have to be used, they are previously split.

In Germany they use branches not more than 40 millimetres thick, as straight as possible, and about 2 feet long; in France from 10 to 35 millimetres for dogwood, and from 27 to 70 millimetres for soft woods. At Waltham Abbey the branches are allowed to be a little thicker, but they must be made as uniform as possible by splitting. Dogwood is accepted there between  $\frac{5}{8}$  and  $1\frac{1}{8}$  inches thick, and alder-wood up to 2 inches thick. The length of the wood varies with the dimensions of the retorts. In Germany it should be 1 or 2 feet long; in France between 1.25 and 1.30 metres long; in Switzerland 1.50 metres long. The method of storing depends upon the kind of wood. Dogwood is generally stacked under shelter, and other woods in the open air. This is in order to give the rain an opportunity of washing out the sap from the wood, and to cause a destruction of the spiral cells by the action of the air and the sun's heat. The time of drying is between two and three years. In Germany they are satisfied with a minimum of three months.

### 8. CHARCOAL MADE FROM RYE STRAW.

The charcoal used for manufacturing brown powder, or cocoa powder as it was called, with a view of keeping its composition a secret, is made from rye straw. The straw is stored in stacks in the open air for a long time, its stalks being as large and as thick as possible, with the ears removed. Great precautions are taken for keeping the process of charring the rye straw secret by the factories making cocoa powder. As far as the author has been able to ascertain, it is done in large wrought-iron steam-heated apparatus. The straw is, he believes, simply introduced, and superheated steam admitted, to the action of which the straw



submitted for several hours. The superheated steam dissolves much extractive matter from the straw, and at the same time does not char it beyond the good chocolate colour.

### 9. LAMP-BLACK.

Certain powder mixtures contain lamp-black in place of charcoal. As this is only done with powders of inferior quality and very rarely, there is no need to enter further into its properties. Lamp-black is quite unsuitable for making black powder, as it contains tarry and acid matter.

### 10. WOOD PULP.

In certain powder mixtures, particularly in the absorbing powder used for making gelatine dynamite, finely-ground wood pulp is used. Of the many varieties of wood occurring in nature, only a few can be used for making this pulp. Since the quantity required in explosive factories is comparatively small, manufacturers are usually content to buy wood pulp such as is largely used in paper-making, and thus avoid the expense of putting down a wood-grinding plant.

Wood pulp is used almost exclusively for manufacturing paper and cardboard. It is usually made by vertical or horizontal grindstones, against which a number of blocks of wood are pressed by means of counter-weights, whilst water is constantly run over the stone. The pulp thus produced is frequently put through one or more pairs of mill-stones, in order to obtain a finer degree of sub-division, and sometimes it is also passed through knot-catchers to remove any larger particles. The water is then removed from the pulp by an aspirating apparatus, and the pulp dried at a gentle heat. This wood pulp is sold in the trade in various degrees of fineness. Dynamite manufacturers specify that it must easily pass through a brass sieve of fifteen meshes to the linear inch.

Wood pulp is generally made from pine, and occasionally from aspen and poplar-wood. What is known as air-dry pulp contains about 12 per cent. of moisture, and a varying quantity of resinous and incrustating substances. Cellulose, as is well known, is a very unstable body, which, especially on heating, easily gives off oxygen, and on the slightest provocation alters its composition. It has not, therefore, yet been found possible

to specify definitely the properties of a wood pulp suitable for making explosives.

It is customary to roast the wood pulp in order to dry it, and drive off the humus constituents; but by doing this it is easy to develop acetic acid, and to alter the composition of the cellulose itself. A good deal depends on the original composition of the cellulose, but, as has been said before, it is very difficult to state a general rule, and probably more difficult still to select and find the kind of wood to fulfil the requirements, and to induce the wood-grinder to use certain qualities of wood, since the wood pulp very considerably influences the stability of the gelatine dynamite, and also the rapidity of combustion of black powder or absorbing powder made with it. All that can be done is to find out by practical experience whether a certain kind of wood pulp is suitable or not.

As a rule, it is sufficient to examine the wood pulp for fineness and for combustibility. To determine the latter, one part of wood pulp and three parts of potassium nitrate are intimately mixed in a wooden mortar and a weighed quantity of the mixture burnt in a loosely-covered crucible; the residue should not be more than 10 per cent. Another part, placed in a small channel made of lead or iron, is ignited at one end, and a note taken of the time it takes to burn to the other.

### 11. FLOUR.

In France and Italy roasted rye-flour, and occasionally wheat-flour, is used as a constituent of absorbing powder for dynamite. There are no special requirements demanded for such flour, as those for the explosive itself are not very severe. Flour has the advantage of being already in a fine state of subdivision, and therefore it does not require any other preliminary treatment beyond roasting. It is also of much simpler chemical composition than wood pulp, and its composition does not alter within certain limits, so that it invites use. On the other hand, however, roasted flour has an inferior absorbing capacity, which is a considerable disadvantage in the manufacture of dynamite.

### 12. COTTON.

Cotton is chiefly used for the manufacture of gun-cotton. In exceptional cases attempts have been made to use fine cotton-fluff as an absorbing material for dynamite. Very few bodies are

so suitable for the manufacture of nitrated cellulose, because, as will be seen from Fig. 31, which shows the appearance of cotton under the microscope, it consists of long tubular fibres of great fineness and softness.

Formerly, cotton taken direct from the pods was used. Now pure undyed or bleached cotton-waste is used. This material has the advantage of having been previously thoroughly purified from husks, seeds, and other foreign particles, and of having had all short fibres eliminated by the processes of carding and spinning. Cotton-waste can be had in different qualities, but there are large dealers who stock those specially suited for gun-



FIG. 31.

cotton. Of course cotton-waste contains a fair quantity of grease from machines, and the fat contained in the cotton itself, and also all sorts of accidental impurities, such as nails, pieces of wood, etc.

For making gun-cotton it is first of all necessary to remove these and all grease from the cotton as thoroughly as possible.

To effect the latter object the cotton is boiled in large tanks with a 2 per cent. soda solution, after which it is washed repeatedly until perfectly neutral. It is then wrung in centrifugal machines, and finally undergoes a preliminary drying by hot air. In some factories, particularly in English ones, this treatment of the cotton with soda has not been found necessary, but as a rule great stress is laid upon it.

In the cotton purifying factory at M.-Gladbach the cotton is charged with soda lye into high-pressure boilers, and afterwards washed in wool-washing machines provided with paddles. It is then bleached with chlorine in lead-lined vacuum pans, next acidulated with sulphuric and hydrochloric acid, again washed in washing-machines, and finally centrifuged and dried. In this factory greasy cotton-waste is previously washed with lime-water under pressure.

Good clean cotton should just sink in distilled water. Unpurified cotton floats on water because its specific gravity is slightly smaller on account of the grease it contains. Chemically it should be perfectly neutral, and at the moment of using should not contain more than 0.5 per cent. of moisture. In Germany they specify that the cotton when thrown into water should sink within two minutes, that it should not form a pulp on nitrating, that on treatment with ether it should not show more than 0.9 per cent. of fat, and that only traces of calcium chloride, magnesia, iron, sulphuric or phosphoric acid should be present. In England the requirements are that cotton when treated in Soxhlet's extraction apparatus with 100 cubic centimetres of ether for four hours should not show more than 1.1 per cent. of fat, and that when dried in an air-bath at 100° C. it should not show more than 8 per cent. of humidity.

Since greasy cotton is liable to spontaneous combustion, it is well to store it in lofty rooms, in not too large bales.

### 13. GLYCERIN [ $C_3H_5(OH)_3 = C_3H_8O_3$ ].

Glycerin is obtained as a by-product in the manufacture of stearine candles, and also in the manufacture of soaps. In the former, fat is saponified by means of lime or superheated steam, and the resulting fatty soaps are further treated. Below the soaps a liquid is found which, according to the process used, contains larger or smaller quantities of glycerin in solution.

Saponification is now chiefly carried out in autoclaves with an addition of about 1½ to 2 per cent. of lime and about one-third of water. The fat is submitted to a pressure of about 120 lbs. in these autoclaves. The glycerin lye is concentrated in vacuum pans until it has a specific gravity of 1.240. In this state it is of a dark-brown colour, and is used for treatment as crude glycerin.

Until a few years ago the crude glycerin was prepared for the manufacture of nitro-glycerin by the so-called refining process.

This consisted in treating the crude glycerin with carbonic acid in large iron vessels. The carbonic acid was made in a lime-kiln, and before entering the glycerin it was passed through some purifiers. The object of the carbonic acid was to precipitate the calcium contained in the glycerin. The purified crude glycerin after being passed through a filter-press was run into a vacuum pan, where it was concentrated to a specific gravity of 1.262.

Now-a-days, all crude glycerin obtained in the manufacture of candles is purified by distillation. The following is the process used:—

Cylindrical copper stills are bricked into a furnace or rest on a brick base, and are covered with insulating composition, in order to prevent loss of heat. The proper quantity of crude glycerin is introduced into these stills and superheated steam blown in. This is produced either in a special superheater or in coils placed in the fire, through which the steam passes. The superheated steam enters the apparatus at a temperature of about 280° C., and volatilizes the pure glycerin which passes out and is condensed in a suitable apparatus.

It is customary to interpose between the still and the condensing apparatus a catcher to retain any crude glycerin that may get over. The condensing apparatus are usually vertical pipes connected alternately on the top and bottom with bends. The lower bends have a tube made in the shape of a trap, so that the glycerin can be obtained in fractions. Sometimes square boxes are arranged in the place of pipes, and they are divided by means of a partition reaching nearly to the bottom. This is tantamount to two tubes, but the cooling is not so complete. Underneath each trap-pipe a collecting vessel is placed for the condensed glycerin. The first collecting vessel yields the strongest glycerin, and the furthest the most dilute, since glycerin begins to condense at a temperature of about 100° C.

In some factories horizontal cylinders fitted with a stirring gear bricked into a furnace are used in place of stills. The glycerin obtained from the stills is sometimes rather dark-coloured, and it is therefore mixed with animal charcoal and passed through a filter-press. In order to bring it up to the high concentration required for the manufacture of nitro-glycerin, it is generally concentrated in vacuum pans.

A distilling apparatus introduced by Alarik Liedbeck consists of an iron still bricked into a furnace in such manner that the flame does not touch the bottom of the still directly, but plays

on the fire-brick arch and passes round the still in two branches through openings left on the sides of the arch. The shaft of the stirring-gear enters through the cover of the still, and is worked by pulleys and cog-wheels from a shafting. The superheated steam is admitted through the shaft of the stirrer, which is hollow, and a ring of perforated pipes is connected with the stirring paddles. The superheated steam is produced in superheaters, consisting, in the main, of a number of pipes cast in one piece and connected alternately by means of elbows. These superheaters are placed in the fire of the still, and the steam, which has been previously freed from water by a trap, passes through them. The admission of steam is controlled by a valve actuated from below by means of a chain and sprocket-wheel. The still and the condensers, of which more will be said later on, are in connection with an air-pump which produces as high a vacuum as possible. At the bottom of the still there is an outlet pipe, which passes through the brickwork, and is closed by means of an elbow-valve. This outlet-pipe serves for emptying the so-called "glycerin pitch" from the still.

The condensation of the glycerin vapours is effected in two surface condensers, in the first of which the tubes are surrounded by steam in order to condense the glycerin only, and not the steam passing over with it. In the second condenser water surrounds the tubes, and dilute glycerin condenses. Both condensers consist of a number of brass tubes connected by a tube plate at each end, and placed in a copper cylinder. The glycerin passes through the tubes, which in one case are surrounded by steam and in the other by cold water, as mentioned above. The bottom of these condensers is enlarged to form a collecting vessel, from which the glycerin is continually withdrawn by a pump.

The yield of pure glycerin varies with the strength of crude glycerin used; as a rule, it is between 90 and 92 per cent. of the theoretical quantity. The consumption of coal also varies. A consumption equal to the weight of glycerin produced is considered moderate.

During the last eight years or so, glycerin has been obtained in much larger quantities from the so-called soap lyes. In the manufacture of soap, fat is boiled either with a potassium or sodium solution, and the soap formed is separated from the aqueous solution by the addition of salt. Below the soap, floating on the surface, there is a liquid, the so-called soap lye, which

contains considerable quantities of glycerin; but until the year 1885 it was generally run to waste, although attempts to recover the glycerin from these lyes had previously been made.

A large number of patents for working up these soap lyes have been taken out within the last ten years, but the process of O. C. Hagemann and Albert Domeier has alone been used on a large scale.

The soap lyes besides water and glycerin also contain resin and organic impurities, sodium chloride, potassium chloride, and various sulphates and carbonates. The composition of soap lyes varies. Kingzett gives their composition after concentration as—

	Per cent.
Water ... ..	60·97
Glycerin ... ..	16·52
Salts ... ..	22·51
Total ...	100·00

in which the 22·51 per cent. of salts had the following composition:—

	Per cent.
Sodium chloride ... ..	78·12
Sodium sulphate ... ..	8·61
Insoluble inorganic compounds ... ..	0·22
Glycerin and organic compounds ... ..	3·55
Water ... ..	7·50
Alkaline matter, calculated as sodium carbonate ... ..	2·61
Total ...	100·61

The Hagemann and Domeier process is, according to their patent specification, as follows:—

About  $1\frac{1}{2}$  per cent. of lime is added to the soap lyes, whereby the alkali contained in them is transformed into caustic alkali. The resulting calcium carbonate is precipitated, and then the lyes concentrated up to the point at which the salt begins to precipitate. At this point resin is introduced, which by its saponification takes up the alkali, about 10 per cent. more resin than is required being added. After boiling for a short time the resin is converted into resin-soap, which floats on the surface together with the non-saponified resin, and is skimmed off. The resinous soaps may be used for making yellow soap. Certain lyes also contain impurities in the shape of sulphites and cyanides. They are therefore treated with iron chloride, or more recently with kaolin, in order to throw down fat and other impurities. After this between three and four parts of hydrochloric acid are added, and air blown through the hot liquid for several hours, by



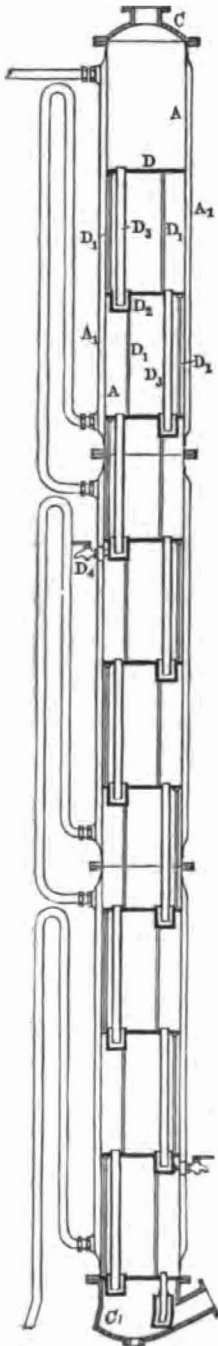

Fig. 32.

which means sulphurous acid is driven off and sulphur precipitated. Finally, on adding a solution of bleaching powder, sulphur precipitates and is removed. The lyes are then neutralized.

According to the later patent of Hagemann, calcium chloride only is added, instead of treating the lyes with hydrochloric acid and calcium chloride. It has the advantage of being free from arsenic, which cannot always be ensured with hydrochloric or sulphuric acid. The solution of calcium chloride is added until the precipitate ceases to form, the clear solution being then decanted and evaporated.

Since the liquid contains large quantities of salts, its concentration can only be carried out in ordinary concentrating pans by taking special precautions, for they would otherwise crack, on account of the salts precipitated on the bottom. It is therefore advantageous to concentrate in pans with side or surface heating. The usual concentrating pan has a hemispherical bottom and a conical cover, which is surrounded by flues from the fire. At the bottom there is a valve to discharge the precipitated salt.

The crude glycerin is next distilled, but as it always contains about 10 per cent. of salts, the distillation is somewhat difficult. If the work is not continuous, the salt precipitating on the bottom of the still can be drawn off with the pitch at the end of the operation. For continuous distillation special precautions are necessary. The distilling apparatus used in the Hagemann and Domeier process consists of a cylindrical vessel with a conical bottom, from which the separated salt is discharged by opening a valve from time to time. The glycerin runs into it in a continuous stream, and a vacuum is maintained in the still. A column condensing



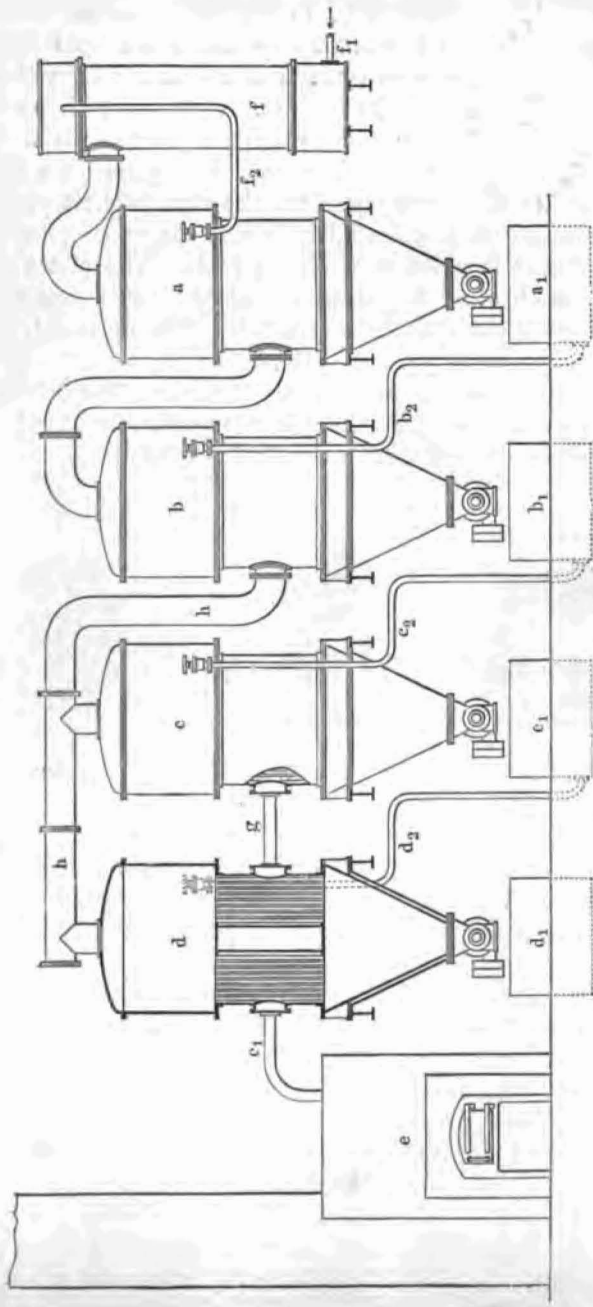

FIG. 33.

apparatus, which is illustrated in Fig. 32, is connected with it. Generally three such condensing apparatus are used conjointly. The condensing apparatus consists of a number of cylinders (A) surrounded with a water-jacket, and connected with each other by means of flanges. In these cylinders are the plates (D) with perforations about  $\frac{1}{2}$ th inch diameter. Each plate has a recess (D<sub>2</sub>) into which the discharge-pipe from the next highest plates dips. This discharge-pipe projects a little above the upper plate, so that a layer of fluid is maintained on the plate. The plates are supported on each other by means of feet (D<sub>1</sub>), while taps (D<sub>4</sub>) serve for drawing off the condensed products. The apparatus is closed on the top by a cover (c), and at the bottom by a bottom piece (c<sub>1</sub>).

The glycerin and water vapours enter into the bottom piece of the first condenser, pass through the perforations in the plates, and deposit on each of them a thin layer of liquid.

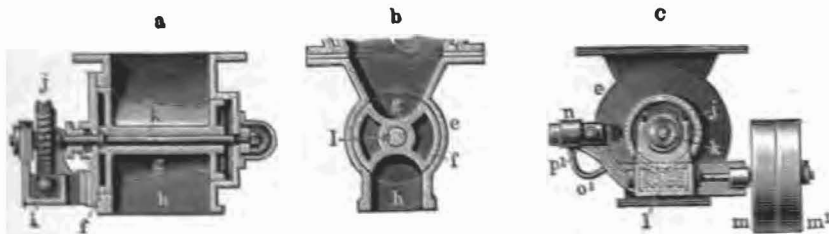

FIG. 34.

FIG. 35.

FIG. 36.

The upper end of the cylinder is connected to the lower end of the next condenser, and so on, all the glycerin being condensed on the way. Volatile organic impurities are carried to the last condenser on account of the high temperature maintained in the apparatus.

Messrs. E. Scott and Son, London, use the multiple distilling apparatus illustrated in Fig. 33. There are four distilling vessels with conical bottoms arranged side by side, and connected with each other. The two first (d and c) work with a lower vacuum than the following ones, so that the vapours issuing from them heat the third apparatus (b), those of the third one heat the fourth one (a) and finally go into the condenser (f).

An essential novelty with this apparatus is the tap placed at the bottom, which allows the continual removal of the salt which separates out. The tap (Figs. 34 to 36) consists of a body (e) in which a conical plug (f) moves. This plug has two cavities (g)

which, as the plug rotates, alternately fill and discharge. The tap is rotated by the spindle (k) and the worm and wheel (i and j), which are driven from a pulley (m). In order to prevent air getting into the still, a spring-valve is placed in a box (n) fixed to the body of the tap, which is connected by means of the pipe (o') with the body, and by means of the connection (p') with the vacuum pump.

The salt separated out in the stills is washed with salt-liquor, and is then of sufficient purity to be again used for the manufacture of soap.

Glycerin to be suitable for the manufacture of nitro-glycerin must have a specific gravity of at least 1.262, and should be free from lime, sulphuric acid, chlorine, and arsenic. On mixing equal parts of glycerin and a 10 per cent. solution of silver nitrate and leaving it in the dark for ten minutes, it should not show any black turbidity. The glycerin should further be easily nitrated, and the nitrated glycerin should separate cleanly and without leaving flocculent impurities, within ten minutes. The nitro-glycerin when poured into water should not become milky, and should become clear soon after washing. The glycerin should not contain more than 0.25 per cent. of organic and inorganic residue together, of which not more than 0.10 per cent. should be of inorganic matter. Rubbed on the palm of the hand it should not leave an unpleasant smell. A flavour of burnt sugar is not of any consequence, as it is due to the glycerin having been burnt in the still.

In spite of fulfilling these and other prescribed conditions, it may still happen that one glycerin is less suitable for the manufacture of nitro-glycerin than another, as the nitro-glycerin made from it will not stand the English heat test. The causes of this have not yet been completely elucidated.

The examination of glycerin is conducted as follows:—

The specific gravity is determined at 15° C. in a Sprengel's apparatus, or in a specific gravity bottle. A qualitative examination is made for chlorine with silver nitrate, for sulphuric acid with barium chloride, and for lime with ammonium oxalate. Further, the silver test described above shows the presence of fatty acids, and finally the residue is determined. This is done by weighing 25 grammes of glycerin in a platinum dish and evaporating slowly in a water or sand-bath, or over a small flame. The evaporation is quickened by blowing over the surface with a pointed glass tube. If an open flame be used careful heating is

necessary, since otherwise the glycerin catches fire, and vapours of acrolein are developed at a temperature above 160° C.

In the old method, as soon as the residue became thick the flame was taken away, and the final evaporation done in an air-bath at 160° C. with the assistance of a vacuum. Some experiments made by Mr. Otto Hehner have shown that this proceeding does not give exact results. There was such a difference according to the quantity taken for the operation that with a perfectly faultless glycerin, for instance, the residue on evaporating 5 grammes was 0·05 per cent., while on evaporating 25 grammes of the same glycerin it amounted to 0·35 per cent. M. Schalkwijk has informed the author that this difference can be avoided altogether if at the finish water is repeatedly added to the residue to prevent its thickening. In this case the quantity of glycerin evaporated does not influence the percentage of residue, and the whole examination is finished much more quickly. As soon as the residue is evaporated to dryness, the platinum dish is cooled in a desiccator and weighed. The residue gives the quantity of organic and inorganic impurities taken together. After this the contents of the platinum dish are calcined and again cooled in a desiccator. The remaining residue is the quantity of inorganic matter, and the difference of weight is, of course, that of organic impurities.

For the nitrating test 10 grammes of glycerin are slowly poured into a mixture of  $27\frac{1}{2}$  parts of nitric acid of 1·500 specific gravity, and  $72\frac{1}{2}$  parts of sulphuric acid of 1·840 specific gravity. The beaker is dipped into a bucket of cold water with the one hand, and continually shaken during the running of the glycerin. After the nitration is finished, the nitro-glycerin floating on the top is decanted in a separating funnel, and afterwards, together with the remaining acid, is kept standing in long burettes for half-an-hour.

As previously stated, the separation of the bulk of the nitro-glycerin ought to take place within ten minutes and without any flocculent residue being left. After standing half-an-hour there will have separated below the nitro-glycerin some acid, and in the other burette on the top of the acid some nitro-glycerin. Both are separated, and the total nitro-glycerin formed is measured. On multiplying the number of cubic centimetres of nitro-glycerin by the specific gravity (1·600) the weight of nitro-glycerin is obtained. This should be at least 200 per cent. of the glycerin employed.

Pure glycerin has no colour and is without odour. It has considerable viscosity, is neutral, and its taste is strongly sweet. It can absorb up to 50 per cent. of moisture from the air, and in a concentrated state it absorbs moisture from the skin, which gives a strong burning sensation; nevertheless, the interesting case of a workman secretly drinking about half-a-pint of glycerin every day, evidently because the burning in the stomach gave him the same sensation as brandy, once came under the author's notice.

Dilute glycerin can, in general, be submitted to very low temperatures, but if a few glycerin crystals are put into glycerin which has been cooled down below  $0^{\circ}$  C., the whole mass then freezes in long monoclinic crystals. This property was formerly utilized by Sarg in Vienna for concentrating dilute glycerin by allowing it to freeze and separating the crystals by means of centrifugal machines. On account of its liability to freeze it is necessary to thaw glycerin in winter, because it freezes almost regularly in the drums, and once frozen it can be left for weeks in the open air at a temperature of  $20^{\circ}$  C. and over without completely thawing. As a rule, therefore, dynamite factories have special houses heated with steam in which the drums are stored a few days before use in order to thaw the glycerin.

The warmer the glycerin the more liquid it is. On the other hand, its specific gravity is diminished, and since, as we shall see later on, the glycerin is as a rule measured and not weighed into the nitrating apparatus, it is of advantage to keep it at such a temperature that whilst its specific gravity is almost the same under any circumstances, it can yet run easily into the apparatus.

Glycerin is completely soluble in water, alcohol, and ether-alcohol, but it is not soluble in ether, carbon disulphide, petroleum-spirit, benzene, or chloroform. It dissolves alkalies and many salts, and also a number of other substances, such as iodine, carbolic acid, etc. When mixed with sulphuric acid it forms sulpho-glyceric acid, of which use has been made in the Boutmy-Faucher process for the manufacture of nitro-glycerin.

On treating glycerin with concentrated nitric acid ordinary nitro-glycerin is formed. On nitrating with dilute nitric acid, or if on nitrating with concentrated nitric acid an excess of glycerin has been employed, part of it will without doubt be converted into mono- and di-nitro-glycerin. These are soluble in concentrated sulphuric acid, so that they are dissolved as soon

as formed, but on standing for a prolonged time they are converted partly into tri-nitro-glycerin, or they come up to the surface of the acid in various forms of easily-decomposed products, which under special circumstances may give rise to a decomposition of the whole mass.

Formerly wooden drums made tight with "glycerin-pitch" were used for the carriage of glycerin. In hot summers considerable leakage occurred from time to time, which sometimes amounted to 50 per cent. of the whole contents. Glycerin has, in spite of its great viscosity, the property of leaking out in large quantities, evidently by capillary action, through the most minute opening or fissure. It is therefore now exclusively carried in iron drums, holding about 10 cwt. and fitted with a screw plug for emptying. It is quite possible that on standing for a long time, or after the empty iron drums have been exposed for some time in the air, rust is formed in them, and is partly taken up by the glycerin. This would considerably increase the percentage of iron and perhaps be a disadvantage in making nitro-glycerin, but with a little precaution it is easily avoided. On the other hand, it has been shown that some glycerin, which although when supplied answered all requirements, after having been stored in tightly-closed drums for several months yielded nitro-glycerin which could only be separated with difficulty. The cause of this is not yet sufficiently cleared up, and it is therefore advisable in keeping glycerin to depend on the results obtained from submitting a large sample to practical nitrating tests on a large scale, and not on analyses alone.

#### 14. BENZENE [C<sub>6</sub>H<sub>6</sub>].

Benzene is a distillation product from tar, and is chiefly found in the light oils coming over at the commencement of the process. Rectified benzene is obtained from crude benzene by washing it with sulphuric acid and soda solution, and then re-distilling. As found in commerce it is never quite pure. The impurities, of which there are a considerable quantity, consist of hydro-carbons, chiefly toluene.

As a rule, a specially pure benzene is not required for explosives, since the greater part of the impurities are hydro-carbons which can be nitrated, and if a certain properly-arranged process is adhered to, benzene alone is chiefly nitrated, the impurities remaining in the waste acid. As a rule, it is sufficient to use 90 per cent. benzene.

This designation of benzene by so much "per cent." does not mean that the sample in question really contained the stated percentage of pure benzene, but that at 100° C. 90 per cent. of the total quantity present distil over. In reality 90 per cent. benzene, according to Allen, sometimes contains about 70 per cent. of benzene, 24 per cent. of toluene, and 4 to 6 per cent. of carbon di-sulphide, acetylene,



FIG. 37.

and light hydro-carbons. Pure benzene has, according to Mendeljeff, a specific gravity of 0.8841. A lower specific gravity shows that it is adulterated with petroleum-spirit, the specific gravity of which is only 0.70.

Benzene is a colourless liquid, which crystallizes at 0° C. and liquefies again between 5° and 7° C. It boils at 80° C., and if

pure the whole of it will distil over within one degree of this temperature. Benzene is soluble in alcohol, ether, acetone, and chloroform, but is insoluble in water. It is a good solvent for resins, fats, essential oils, sulphur, etc. Benzene is highly inflammable and burns with a thick smoky flame. Its vapours when mixed with air are explosive, and as benzene vapour is heavier than air, it generally lies along the floor, so that it may happen that whilst larger quantities are near the floor, a person in the room can only detect a slight smell of the hydro-carbon.

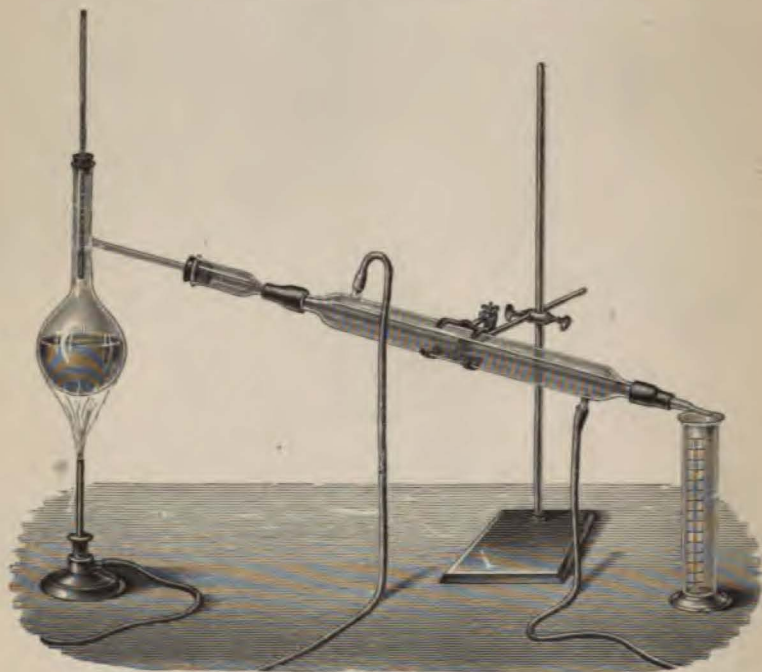

FIG. 38.

Benzene vapours cause giddiness and stupor; in large quantities it is poisonous, and in contact with the skin it causes an unpleasant dryness by dissolving the greasy matter.

The examination of benzene for the manufacture of explosives chiefly relates to its capacity for nitration, to determine which about 100 grammes of benzene are submitted to this test. Professor Lunge's nitrating flask, which is shown in Fig. 37, is very suitable for this purpose; it holds about 500 cubic centimetres. A mixture of 150 grammes of nitric acid of 1.40 specific gravity, and 180 to



200 grammes of sulphuric acid of 1.84 specific gravity, which has been previously cooled, is allowed to run through the thistle funnel (a) drop by drop into the benzene, the flask being shaken and cooled by water. As soon as all the acid has been run in and the temperature ceases to rise, the flask is slightly heated for one or two hours, the tube (b) having been previously replaced by a Liebig's condenser. The contents of the flask are then put into a separating funnel, allowed to rest, and the acid separated from the nitro-benzene. The separated acid is diluted with several times its volume of water, and any oil separating out after a few hours' rest is added to the nitro-benzene. The nitro-benzene is then washed three times with its own volume of water, once with a very dilute soda solution, and once again with water, the water being removed after each washing by means of a separating funnel. The nitro-benzene is then distilled at 150° C. in a fractionating flask (Fig. 38). The residue is again nitrated with an excess of the acid mixture and washed. What then remains is considered incapable of being nitrated. One hundred parts of benzene yield theoretically 157.6 parts of nitro-benzene.

To determine the percentage of benzene a distillation test is used. This is done in the distilling apparatus mentioned above, which is shown in Fig. 38. One hundred cubic centimetres of benzene are carefully measured in a dry measuring cylinder, and poured into the fractionating flask, which must also have been previously dried or rinsed with benzene. The flask is closed with the stopper, through which a thermometer passes, in such a way that the top of the bulb is near the branch-pipe. The heat is applied slowly, and the distillation so regulated that the distillate falls as quickly as is possible in single drops into the measuring cylinder. As soon as the temperature of 100° C. is reached, the volume of the distillate in cubic centimetres is noted, and the distillation continued until finished.

### 15. TOLUENE [ $C_6H_5(CH_3) = C_7H_8$ ].

Toluene is a homologue of benzene, containing one atom of methyl ( $CH_3$ ) in the place of one atom of hydrogen, and like benzene is obtained from tar by distillation. It is a colourless liquid with a smell differing but little from that of benzene, which it also resembles in its other properties. According to Dr. Häussermann (Lunge's 'Coal Tar Industry'), commercial toluene should distil over completely within 1° C. of its boiling-point, and not show any coloration when shaken for a prolonged period with

its own volume of concentrated sulphuric acid. If, however, 90 cubic centimetres of toluene are violently shaken during a few minutes with 10 cubic centimetres of nitric acid of 1.44 specific gravity in a long stoppered glass cylinder, the nitric acid should become red in colour, remaining at the same time, however, perfectly clear and transparent, and not becoming greenish-black and opaque. The distillation test is done in the same manner as with benzene, but is only necessary in cases where toluene contains hydro-carbons which cannot be nitrated; and since the quantity of these is, as a rule, small, a comparatively large quantity of toluene must always be submitted to the nitrating test.

#### 16. NAPHTHALENE [ $C_{10}H_8$ ].

Naphthalene is found in the light oils from tar distillation such as creosote oil, but chiefly in the carbolic oil which distils over between 210° and 240° C. Full information as to its manufacture and purification may be found in Professor Lunge's book on 'Coal Tar Industry.' Naphthalene forms brilliant thin laminae with a peculiar tar-like smell. It melts at 79° C. and boils at 270° C. Its specific gravity is 1.1517. It is volatile at ordinary temperatures, insoluble in water, but easily soluble in alcohol and ether, and burns with a very sooty flame. It is to be obtained in commerce almost chemically pure.

#### 17. PHENOL (*Carbolic Acid*) [ $C_6H_5OH=C_6H_5O$ ].

A full account of the manufacture of phenol can also be obtained from Professor Lunge's work on the 'Coal Tar Industry.' In a pure state it forms long white prisms of characteristic smell, melts at 42.2° C. to a clear colourless liquid, and boils at 182° C. without decomposition. Its specific gravity at 18° C. is 1.065. It absorbs moisture from the air, but is not easily soluble in water, though it is soluble in all proportions in alcohol, ether, benzene, glycerin, etc. A red coloration in phenol is no detriment to its use for the manufacture of explosives. It can be obtained in commerce almost chemically pure, or containing at most only traces of mineral impurities. The examination of phenol for its percentage of water is performed by shaking it with five times its weight of finely-slimed oxide of lead, and drying between 70° and 80° C. until of constant weight. The percentage of phenol is best

found by a method proposed by Koppeschar, which, according to Lunge, is conducted as follows:—

The re-agents required are: first, a solution of sodium thio-sulphate, made to correspond exactly to an iodine solution containing 5 g. of iodine to the litre; second, a solution of starch; third, bromine water of such strength that 50 cubic centimetres of it after decomposition with potassium iodide require between 18 and 20 cubic centimetres of thio-sulphate solution; fourth, a solution of potassium iodide, which contains 125 grammes of KI to the litre.

Four grammes of carbolic acid are dissolved in water and diluted to a litre, 25 cubic centimetres of this solution are transferred by means of a pipette into a glass-stoppered flask of half a litre. It is then closed and shaken for some time; 50 cubic centimetres of the bromine water are measured by a pipette into a small beaker containing 5 cubic centimetres of the potassium iodide solution. After half-an-hour the contents of the half-litre flask are emptied into a large beaker, containing 5 cubic centimetres of the potassium iodide solution, and the flask is twice rinsed into the same beaker. The liquids in the small and in the large beaker are then titrated by adding at the finish of the operation a little starch solution and taking the reading when after a few moments the blue colour does not appear again. Thus, suppose 25 cubic centimetres of phenol solution have been employed corresponding to 0.1 gramme of phenol; to this 47.5 cubic centimetres of bromine water were added, and 50 cubic centimetres of the latter were titrated with the thio-sulphate solution of the strength mentioned. Let (A) be the number of cubic centimetres of the thio-sulphate required for the 50 cubic centimetres of bromine water, and let (B) be the number of cubic centimetres of thio-sulphate solution used for the excess of bromine in the 25 centimetres of solution, then the formula— $(9.5 A - B) 0.61753$ —will give the percentage of phenol in the sample.

### 18. CRESOL $[C_6H_4(CH_3)(OH) = C_7H_8O]$ .

Cresol is a homologue of phenol. There are three isomers—ortho-cresol, para-cresol, and meta-cresol. The cresylic acid of commerce contains about 40 per cent. of meta-cresol, 35 per cent. of ortho-cresol, and 25 per cent. of para-cresol. It is a colourless liquid of 1.044 specific gravity, and has a boiling-point of between 185° and 203° C. At present meta-cresol only is used for making

explosives. It is a thick liquid boiling at about 200° C., and does not solidify even at a very low temperature. Ortho-cresol and para-cresol are crystalline, and their nitration is somewhat difficult. Cresol is only slightly soluble in water, and has in general the properties of carboic acid.

### 19. KIESELGUHR.

The absorbing material first used for nitro-glycerin was kieselguhr, an infusorial earth found in the Lüneburg moors,



FIG. 39.—Three hundred times full size.

chiefly near Unterlüss, between Bremen and Hanover. Under the microscope it consists chiefly of shells of diatomacæ (Figs. 39 and 40). All its parts are cellular, and hence each particle forms a kind of reservoir, capable of holding liquid; it is this structure that makes kieselguhr so highly absorbent. With the best varieties, the absorbing capacity for nitro-glycerin is as high as 82 per cent.

At Unterlüss kieselguhr is found in various strata, generally

immediately below the surface, but its purity changes very much. Frequently the upper layer is much contaminated with lime, iron, etc. Some strata contain more lime than others, some again more earthy material. The colour also differs. On calcining kieselguhr the colour often changes from pure white to yellowish-green and grey, these again passing into pink and bright orange, whilst sometimes it remains white. The coloration is chiefly due to oxide of iron, and sometimes to the admixture of clay.



FIG. 40.—Three hundred times full size.

The best kieselguhr is of a pure white, and on calcining changes its colour to a pale pink. Kieselguhr is also found in many other places, as, for instance, in Scotland, France, and Italy, and in considerable quantities in Norway, where it is found at the bottom of numerous lakes, and covers old lake beds. This is chiefly the case in the neighbourhood of Stavanger, but the Norwegian kieselguhr is as a rule not so pure as the Hanoverian. In the Lüneburg moors kieselguhr is chiefly

obtained by excavation and then purified by sliming. The finest quality is sold as "white slimed" kieselguhr for the purpose of making dynamite. Inferior qualities, especially such as are otherwise pure but contain a good deal of organic matter, are placed into large chambers and slightly calcined by means of a

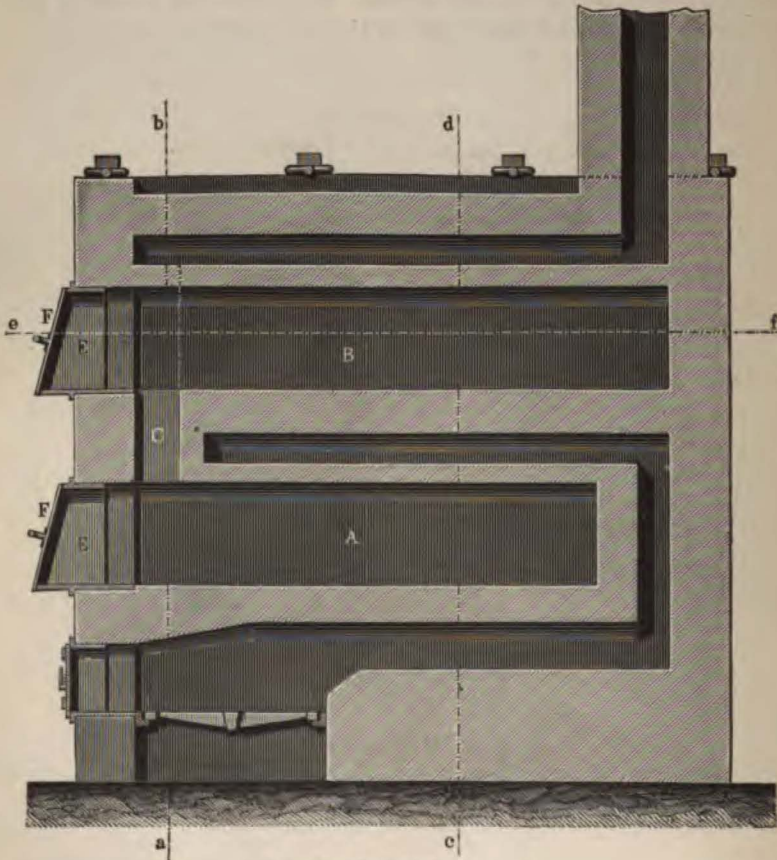

FIG. 41.—One-40th full size.

fire. In the ordinary process kieselguhr is dried in the open air, or in heated rooms.

Kieselguhr consists almost entirely of silica with traces of oxide of iron, organic matter, and sometimes some alumina or sulphate of aluminium. A percentage of sulphate of aluminium has been proved to be disadvantageous in making dynamite, as



it affects its stability. In dynamite factories kieselguhr is first of all submitted to a calcining process. For this purpose open flame-furnaces or muffle-furnaces are used. Open flame-furnaces are constructed in the usual way, and the kieselguhr is frequently raked over whilst in them. The disadvantage of using them is

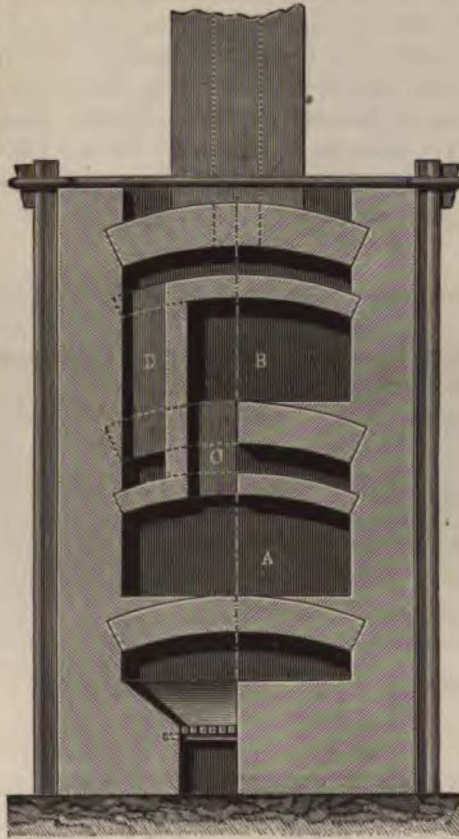

FIG. 42.—One-40th full size.

that particles of soot and coal deposit on the kieselguhr, giving it a bad colour, and somewhat decreasing its absorbing capacity.

Sometimes kieselguhr is simply spread out on a hearth of iron plates and there calcined, but in this manner the kieselguhr can be easily burnt dead, which will diminish its absorbing capacity. The most advantageous process, although not the most economical as far as coal consumption goes, is calcining in muffle-furnaces. Figs. 41 to 43 show a form designed by the author

which gives very good results. It consists of two muffles (A and B), which are connected with each other by means of a shoot (C) going through the flue. The fire passes along the bottom of the first muffle (A), from thence over the arch of the same and under the bottom of the second muffle (B), then through two connecting flues (DD) over the arch of the second muffle and into the chimney. The charging doors (E) are inclined in front, and have covers loosely hung to allow the moisture to escape. The upper muffle (B) is charged with the kieselguhr, which, after having been freed there from moisture, is raked down through the shoot (C) into the lower muffle (A), where it is calcined. In the lower muffle the colour of the brickwork and of the kieselguhr when hot should not be more than a dark cherry-red.

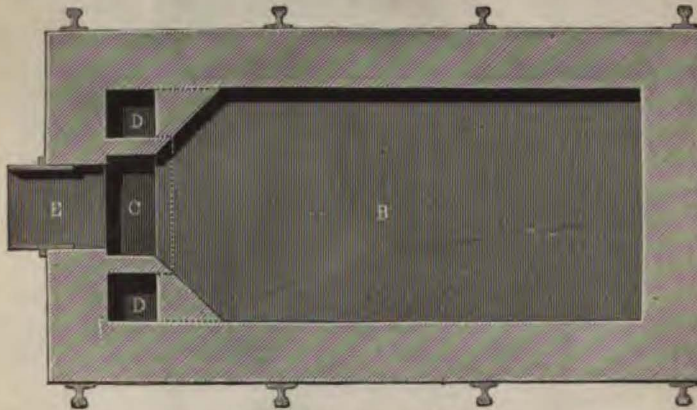

FIG. 43.—One-40th full size.

When the calcination is finished the kieselguhr is drawn out into iron vessels, in which it is allowed to cool. It is then in the form of more or less solid lumps, and also contains small nodules of oxide of iron which are slightly harder than the rest of the mass.

After cooling the kieselguhr is crushed to a fine powder by a pair of rolls. This crushing, however, must not be carried too far. From the rolls it passes through a trommel-sieve, in which all the finest particles are sifted off. After sifting the kieselguhr should not contain more than 1 per cent. of moisture at most. It is then placed in tight bags and used for making dynamite the same day, as it might absorb two and more per cent. of moisture from the air, if kept for a longer time.



## 20. LIMEGUHR.

In stalactite caves, and especially in old river-beds on limestone rocks, a porous tufa is frequently found, which consists chiefly of wart-like nodules, giving when ground a fine porous powder. Although the absorbing capacity of this mass, which to distinguish it from kieselguhr has been called limeguhr, is slightly smaller than that of kieselguhr, it was formerly used in the manufacture of an explosive called "white dynamite," which was made by Charles Diller at St. Lambrecht. It has the advantage of great permanence of absorbing power, the nitro-glycerin in dynamite made with it does not easily exude; and as it consists exclusively of calcium carbonate it had a special value at the time when alkalinity of dynamite was considered to be a great advantage, because it neutralized at once all the traces of acidity which were in time supposed to appear in nitro-glycerin. As has been said above, its absorbing capacity is not so good, as it rarely exceeds 70 per cent. of nitro-glycerin.

## 21. RANDANITE AND OTHER ABSORBING MATERIALS.

There was a time when it was believed that the silica of kieselguhr was essential for making dynamite. During the war of 1870 the French began to make dynamite. They did not like to depend on foreign countries for absorbing materials, and tried to discover a suitable absorbent at home. They found in the neighbourhood of Ceysat, in the Department of Puy-de-Dôme, a mass similar to kieselguhr, which consisted chiefly of decayed feldspathic rocks. In addition to this they used silica from the neighbourhood of Vierzon and Launois, magnesium carbonate, and calcium carbonate ("Blanc de Meudon") as absorbents. Of course they are now no longer used. Tripoli powder which absorbs up to 68 per cent., and even ground bricks, finely-ground coal, cinders, and, especially during the siege of Paris, ashes of boghead coal have also been used.

## 22. ALKALIES.

Most factories, from reasons which will be considered later, find it advisable to add a small quantity of alkali to dynamite and gun-cotton.

Originally, and for a long time, only sodium carbonate was used for this purpose. Experience, however, showed that by

washing gun-cotton with sodium carbonate the yield was reduced, as small quantities were decomposed by it. It was then replaced by calcium carbonate, which later on has also been used for dynamite. Magnesium carbonate is now also used.

Experiments which Dr. August Dupré made with various alkalies showed that sodium carbonate slightly attacks dynamite. According to the author's view every alkali does so, and it will be seen later that such an addition is quite superfluous if the dynamite is properly made. Sodium carbonate is as a rule used in the shape of pure alkali, made either by the Leblanc or the Solvay process. The calcium carbonate used comes chiefly from Meudon as "Blanc de Meudon," whilst magnesium carbonate is a well-known chemical product. All three are to be had of sufficient purity, and since the quantity used is small, a special examination is only necessary when there is cause to doubt their purity.

### 23. OCHRE.

In some factories dynamite is coloured red with ochre. This probably originates from the fact that on calcining kieselguhr in open flame-furnaces it is contaminated with particles of soot. Another reason is that some kinds of kieselguhr leave the furnace with a more or less dirty yellow colour, or are sometimes white, instead of the reddish-yellow colour of the best kinds of calcined kieselguhr. In order to obtain dynamite of a uniform colour burnt ochre was added to the kieselguhr dynamite, and when later on gelatine dynamites were introduced, the miners would have been made suspicious by a differently coloured explosive, and therefore these also received a similar addition.

It is not necessary to dwell upon the special properties of ochre, since the small quantity added to dynamite plays a very insignificant rôle.

Ochre is a loose earthy mineral, found in various countries, and its colouring matter consists chiefly of hydrate of iron or oxide of iron. In the first case it is yellow, and in the latter case red. On calcining its colour changes more or less into red. It is purified by sliming, and is obtained in commerce as a fine powder.

### 24. VASELINE. (*Mineral Jelly.*)

This body is used for reducing the rate of combustion in certain smokeless powders and slightly greasing the barrel on

shooting with them. It is a mixture of petroleum hydro-carbons of high boiling and melting points, and is made either from ozokerite or from the residue from refining American petroleum. In both cases it is filtered through animal charcoal, or treated with sulphuric acid, potassium chromate, or discolouring powders (residue from the manufacture of prussiate of potash). Pure vaseline melts at 32° C., but as a rule a mixture of solid and liquid vaseline which has a pasty consistence is employed. According to the English specification it must be free from foreign admixture, scales, and specks, must have a flashing point of at least 400° F., and its specific gravity taken with the hydrometer must not be below 0.87 at 100° F. Placed in an open dish on a water-bath, the water being boiling, it should not show a loss of more than 0.2 per cent. in weight after twelve hours' heating. It should have a melting-point not below 86° F., and be free from acidity and solid mineral matter.

Vaseline is very stable, and does not become acid and rancid. It also does not become gummy, and cannot be saponified, though if mixed with stearine or beeswax it can be partially saponified.

#### 25. PARAFFIN WAX.

In certain exceptional cases paraffin wax is an ingredient of smokeless powders. Its melting-point varies with its hardness, and the manner in which it has been produced. It is between 40° and 60° C., and is selected according to the special requirements of the case. Of course, paraffin cannot be simply mixed with other components, but must be added by melting it in. In consequence of its having been treated in its manufacture with sulphuric acid, it is sometimes slightly acid, but this can be removed by washing when melted.

#### 26. ACETONE (C<sub>3</sub>H<sub>6</sub>O).

When speaking above of the distillation of wood, it was stated that the products of distillation are volatile and liquid bodies. Amongst the products passing over in the manufacture of acetic acid by the destructive distillation of wood, and condensed in the cooling apparatus, are methylic alcohol and acetone. On rectifying the methylic alcohol, acetone passes over, and is condensed separately. It can be purified by treating it with sodium bi-sulphate and decomposing with soda.

On a large scale acetone is made by the decomposition of acetate of lime. An apparatus for this purpose, which has been erected at the Royal Gunpowder Factory, Waltham Abbey, by the author, and made by Richard Luhn of Haspe, is shown in Fig. 44. It consists of a cast-iron still (a), with a stirring-paddle (b), a dust-catcher (c), a condenser (d), and a pyrometer (e) for measuring the temperatures. The object of the dust-catcher is to retain any calcium acetate dust, which may be carried over mechanically, and which can be removed through the cleaning

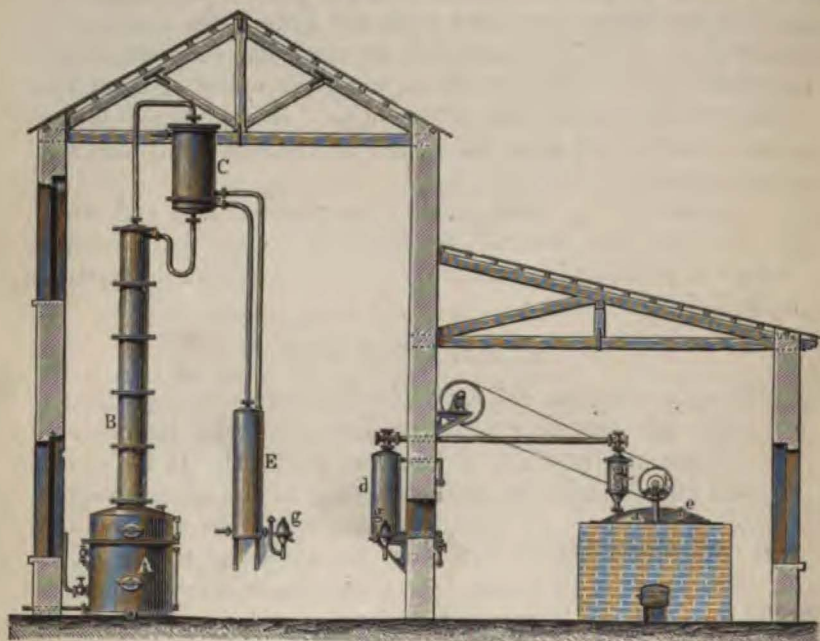

FIG. 44.—One-125th full size.

doors ( $f'$  and  $f''$ ).  $g$  is an alcohol-lute for observing the process of distillation. This apparatus gives crude acetone, the yield being about 22 parts of crude acetone for 100 parts of pure acetate of lime of 80 per cent. The temperature required for decomposition is about  $752^{\circ}$  F. ( $400^{\circ}$  C.). The crude acetone is then submitted to a further distillation in the rectifying apparatus (shown on the left-hand side of Fig. 44). This consists of a copper still (A), holding about 335 gallons, in which the acetone is heated by steam. Above the still is a column (B) with the

usual inlets and outlets, which is fitted with a number of finely-perforated copper plates. There is a condenser (c) connected with the column, which condenses any water that may pass over and returns it to the column. A pipe leads from the condenser to the cooler (E) in which refined acetone is condensed. This cooler also has an alcohol-lute (g). With this apparatus 21 parts of pure acetone are obtained from 22 parts of the crude acetone.

On account of the great inflammability of acetone it is advisable to isolate the cooler from the fire of the crude acetone still.

In another process, invented by Schwartz, acetone is prepared by decomposing acetate of lime by superheated steam. In order to obtain condensation of the steam the water in the cooler would have to be heated, and the acetone condensed in a second one.

Acetone is a perfectly clear liquid, boiling at  $58^{\circ}$  C., and having a slightly empyreumatic smell. Both acetone and its vapours are combustible, and the latter when mixed with air are explosive. Caution, both when stirring and using it, is therefore necessary. Its specific gravity is about 0.800.

The specifications of all military authorities for acetone are about the same. In Germany and Austria it is specified—Firstly, that the acetone should be perfectly clear and colourless; secondly, that it should be miscible in all proportions with distilled water, and that this mixture should not show turbidity, or give a precipitate either immediately or after prolonged rest; thirdly, that it should be perfectly neutral; fourthly, that on testing it at  $150^{\circ}$  C. with the weight-thermo-alcoholometer it should show at least 98.2 per cent.; fifthly, that it should not contain more than 0.1 per cent. of aldehyde; sixthly, that the iodometric test should show 98 per cent. of pure acetone; and seventhly, that on heating it at  $58^{\circ}$  C., at least 95 per cent. of acetone should distil over.

The English Government specify: that the specific gravity at  $60^{\circ}$  F. shall not exceed 0.802; that on evaporating at  $212^{\circ}$  F. no residue shall be left; that four-fifths of the volume tested should distil over at a maximum temperature of  $138^{\circ}$  F.; that the residue after distillation shall not contain any constituent which is not a result of the manufacture besides acetone; that the acetone shall not contain more than 0.005 per cent. of acidity (calculated as acetic acid); and that the distinct coloration shall be retained at least two minutes after 1 cubic centimetre of 0.10 per cent. solution of pure potassium permanganate is added to 100 cubic centimetres of acetone.

Testing by the weight-thermo-alcoholometer is done in an

apparatus made by G. A. Schulze, of Berlin. The amount of aldehyde is determined by reducing a silver solution, consisting of 3 grammes of crystallized silver nitrate, 3 grammes of sodium hydrate, and 20 grammes of ammonia solution (of about 0.9 specific gravity) made up to 100 cubic centimetres. The solution will keep good for a long time in the dark. Ten cubic centimetres of the acetone to be tested are added to 10 cubic centimetres of distilled water, to which 2 cubic centimetres of silver solution, made as above described, have been added, and kept standing in the dark for a quarter of an hour. The liquid is decanted from the reduced silver, and is tested for unreduced silver by means of as clear as possible a solution of ammonium sulphate. If unreduced silver be found the percentage of aldehydes in the acetone is less than 0.1 per cent. The excess of the silver is shown by a brownish-black precipitate, or a brown turbidity of the liquid.

The iodometric determination of acetone was first described by Krämer. By it acetone is transformed quantitatively into iodoform at ordinary temperatures, by an excess of iodine solution in the presence of sodium solution—

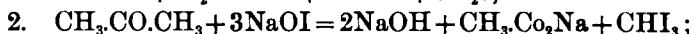

that is, one molecule of acetone is transformed into one molecule of iodoform by 6 atoms of iodine; 58 grammes of acetone correspond therefore to 761.1 grammes of iodine. The quantity of iodine which has not been used remains, according to the first formula, as NaI and NaOI, the iodine in which, on neutralizing with hydrochloric acid, again becomes free, and is determined with sodium thio-sulphate.

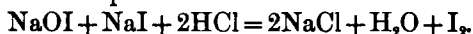

For the purpose of examination 8 grammes of acetone are carefully weighed and dissolved in water, the solution being made up to 1 litre. Ten cubic centimetres of this solution are put into a bottle fitted with a well-ground glass stopper, and holding 250 cubic centimetres. To this 50 cubic centimetres of normal sodium solution are added, and 50 cubic centimetres of fifth-normal or quarter-normal iodine solution are run in, the whole being vigorously shaken for half-an-hour. The liquid on the stopper is washed into the bottle, 50 cubic centimetres of normal hydrochloric acid run in, and the liberated iodine titrated with deci-normal sodium thio-sulphate solution, until the colour produced on adding clear starch paste disappears. The number of cubic centimetres of thio-sulphate solution is calculated to their

equivalent of iodine solution, and deducted from the 50 cubic centimetres used. The difference is expressed in per cents., by weight, of acetone. It must be borne in mind that 1 gramme of acetone corresponds to 517.26 cubic centimetres of fifth-normal and 413.8 cubic centimetres of quarter-normal iodine solution. The alkalinity is tested by adding 1 cubic centimetre of deci-normal soda solution to 100 cubic centimetres of acetone, to which a few drops of phenol-phtaleïne solution have been previously added, when a distinct red coloration should take place. A solution of mercuric chloride should not produce any turbidity in the acetone.

The English Government specify that the testing for acidity is to be performed as follows:—50 cubic centimetres of acetone are diluted with 50 cubic centimetres of distilled water, 2 cubic centimetres of phenol-phtaleïne solution (1 gramme for 1000 cubic centimetres of 50 per cent. alcohol) added, and the liquid titrated with 100th-normal soda solution from a burette. Here 1 cubic centimetre of soda solution corresponds to 0.0006 gramme of acetic acid.

The determination of the boiling-point of acetone must be done carefully. In order to get an exact result 80 to 100 grammes of acetone are weighed into a dried flask holding about 150 cubic centimetres. This is placed on a sheet of asbestos, about 8 inches square and  $\frac{1}{4}$  inch thick, in the centre of which a hole about an inch diameter has been cut, and is heated by an open flame. As the flask has on the bottom a diameter of about  $1\frac{1}{2}$  inches it rests on all sides, with the exception of the hole which is touched by the flame, on the sheet of asbestos, and is thereby protected from radiant heat. The distillate is collected in a dried and weighed bottle, and the percentage which has passed over at the boiling temperature can be easily calculated from the quantities employed and obtained.

Acetone is soluble in water, alcohol, chloroform, and ether. It dissolves resins, fats, camphor, gun-cotton, and nitro-glycerin, but it does not dissolve potassium, sodium, chlorine, or calcium. In the manufacture of smokeless powder it is used for dissolving gun-cotton and nitro-glycerin. A sample of acetone made by Hugo Blank in Berlin, and examined according to the English specification, showed:—

Specific gravity at 15° C., 0.7965.

On distilling at a temperature of between 56.2° and 56.4° C., 98 per cent. passed over.

Permanganate test. The coloration remained for nine minutes.

Acidity 0.0025 per cent.

A very delicate test for detecting acetone has been described by Schwicker. To the solution to be tested a few drops of ammonia of 0.890 specific gravity, and 2 drops of deci-normal iodine solution are added. A cloudy precipitate of nitrogen-iodide is formed, which on shaking, or slight heating, disappears and forms a precipitate of iodoform. The reaction is trustworthy to  $\frac{1}{10000}$  per cent.

### 27. ETHYLIC ETHER (*Sulphuric or Common Ether*) ( $C_2H_5)_2O$ .

On distilling a mixture of sulphuric acid and alcohol a volatile body, commonly known as sulphuric ether, is formed by the elimination of one equivalent of water from the alcohol. The name "sulphuric ether" was given to it in former times on account of its method of manufacture, although it does not contain any sulphur.

The manufacture is carried out in lead distilling apparatus, heated by direct fire, and charged with 9 parts of concentrated sulphuric acid and 5 parts of rectified alcohol of 90 per cent. by volume. The mixture boils at 140° C., and the crude ether which escapes consists of ether, alcohol, water, and a little sulphurous acid. It is condensed in a cooling-worm, and is then rectified in a copper fractional distilling apparatus. The components are collected separately, which is done with the greatest ease, as ether boils at 35° C., alcohol at 78° C., and water at 100° C.

The French Government in 1888 built a special factory for the manufacture of ether, in order to be independent of private manufacturers, and to have its supply assured in the case of war. This seemed to be particularly necessary, because since the introduction of the so-called "B" powders considerable quantities of ether are required. In 1890 alone, nearly 120 tons were ordered.

The Government factory is built in Bordeaux in a neighbourhood conveniently near to the gunpowder works of Pont-de-Buis and St. Médard. The following details are taken from a description in the 'Mémorial des Poudres et Salpêtres,' 1891, p. 32:—

The manufacture is divided into two distinct operations, namely, the production of the crude ether, and its rectification.

For the manufacture of crude ether two apparatus are used. They are cylindrical sheet-iron vessels with a lead lining and copper covers, they are 6 feet 7 inches high, and 5 feet 11 inches



in diameter, and are heated by means of a lead-coil, through which steam of about 45 lbs. pressure passes. To each apparatus there is a thermometer with a scale, an oil-bath, a float, and an open pressure gauge, which also serves as a safety-tube. On starting, each apparatus is charged with about 7050 lbs. of alcohol. Steam is turned on, and the mixture heated to, and kept at, a temperature of about 266° F. The alcohol enters in a continuous stream from a reservoir holding about 330 gallons, into which it is pumped from the storage tanks by means of a small steam-pump, and also from the alcohol rectifying column, of which more will be said later. The rate at which the alcohol runs in is regulated by the inlet-tap, according to the progress of the reaction.

The crude ether vapour from this apparatus, which consists of a mixture of ether, alcohol, and water, together with a small quantity of acid, passes to the saturating vessels, of which there are three, one being a spare one. Each of them is 4 feet 7 inches high by 2 feet square, and is lined all over on the inside with lead. They serve to remove the acid, as completely as possible, from the crude ether. The ether vapours enter by an opening at one side of the bottom, and issue from the top. Placed over each saturating vessel are three lead trays, and on the top of these a cover. The cover and the trays each have a lute sealed with soda solution, which is run on to the cover from a tap, and runs from this on to each of the trays successively. The trays have tubular openings which are fitted with caps, and sealed by the soda solution on the trays. Consequently the vapours must pass through the soda solution before they can escape from the saturating vessels. Experience has shown that 85 per cent. of the total acid contained in the vapour is neutralized by this apparatus, and that for each 812.5 lbs. of crude ether or 400 lbs. of pure ether, 1 lb. of soda is required to effect this. The liquid collecting at the bottom of the saturating vessel is drawn off through a tap into the crude ether storage-tank, where its excess of soda neutralizes the last traces of acidity. The vapours escaping from the saturating vessels are condensed in leaden cooling-worms standing in a sheet-iron tank filled with water. The condensed ether issues through an "alcohol-lute," such as is commonly used with rectifying apparatus, and passes into the storage-tank for crude ether, which holds about 700 gallons.

The rectifying of the crude ether is done by a method similar to that used in the case of acetone, which is described on

page 118. The crude ether is pumped by means of a steam-pump into an overhead tank, holding 330 gallons. The rectification is done in a copper "column" apparatus with 27 plates.

The liquid is evaporated in the column apparatus by means of steam. As the vapour rises in the column it is cooled, and water and alcohol condense and run down the column; whilst the ether, which is volatile at 97° F., and traces of alcohol escape from the top into a condenser, where the remaining alcohol condenses and runs back into the column. The ether passes from the first condenser into a second tubular one, in which it is liquefied and flows out through an alcohol-lute into storage vessels. The mixture of alcohol and water collected in the lower part of the column, after having attained a certain height, is run through an opening on the side into a second column similar to the preceding one, but containing 43 plates. In this the alcohol and water are separated. The alcohol as it runs out from the lute should mark 94°.

The ether issuing from the column has a density of 65°, and is mixed with sufficient alcohol of 95° to make ether of 56° or 52° B., according to requirements. For ether of 56° B. about 91 parts by weight of ether of 65°, and 5 parts by weight of alcohol of 95° are required.

The mixing is done in a store in which there are two storage tanks, each of 545 gallons capacity, and in the centre an alcohol tank. The empty barrels are placed on a weighing-machine, and by opening the taps of the storage vessels alcohol and ether are allowed to run in in the desired proportions.

Each crude ether apparatus yields when working normally 440 lbs. of crude ether per hour, which corresponds to about 220 lbs. of 65° or 341 lbs. of 56°.

The factory thus produces 16,310 lbs. of ether of 56° in twenty-four hours. The rectifying apparatus yields 660 lbs. of pure ether per hour. As its capacity is larger than that of the crude ether apparatus, it need only work about two-thirds of the time. The theoretical yield is one part of pure ether to 1.26 parts of pure alcohol. In actual work 133 lbs. of alcohol of 95° are required for the manufacture of 100 lbs. of ether of 56°. The cost of ether of 56° is 1.342 francs per kilogramme, and adding to this the interest on the working capital and the freight to the powder factories for the full and empty barrels, there was nevertheless a saving of 0.417 franc per kilogramme effected at the factory of Pont-de-Buis. For the orders given out in 1890,

the saving would have therefore been 405,320 francs, whilst the whole installation, including purchase of materials, cost only 360,000 francs; so that the factory paid for itself within one year.

Pure ether is as clear as water, perfectly neutral, and its odour is characteristic and well known. It boils, according to Gay-Lussac, at 35.6° C., and according to Kopp at 34.9° C. Its specific gravity is 0.725. It is soluble in ten volumes of water and miscible in all proportions with alcohol, acetone, methylic alcohol, chloroform, and volatile and fatty oils. It dissolves many organic compounds, including nitro-glycerin, nitro-benzene, etc. It is decomposed at ordinary temperatures by chlorine with the evolution of light and heat and a separation of carbon. Ether vapours when mixed with air are highly explosive. Ether containing water, or mixed with alcohol, shows after some time an acid reaction, through an absorption of oxygen. Pure ether evaporates without residue, and should not have any smell but its own characteristic one. If these two conditions are fulfilled a further examination of ether is unnecessary, as it is then hardly possible that it can be adulterated. Ether is used in the explosives industry for the manufacture of smokeless powders.

### 28. ACETIC ETHER ( $C_2H_3O.O.C_2H_5$ ).

Formerly, acetic ether was generally used, and still is in some cases, for the manufacture of smokeless powder in Germany. It is produced by decomposing sodium acetate by means of sulphuric acid, whereby sodium sulphate and acetic ether are formed.

According to Grosschopf, acetic ether is made on a large scale by distilling anhydrous acetate of sodium with a cooled mixture of concentrated sulphuric acid and alcohol of 95° in copper stills heated by steam and provided with a stirring-gear. Bottles are about two-thirds filled with the crude distillate and then filled up with water, sufficient potassium carbonate being then added, until, on shaking, the liquid no longer gives an acid reaction. The aqueous liquid which separates below the ether is syphoned off, and the ether washed several times by shaking with water. Then, in order to eliminate water, the ether is mixed with fused calcium chloride and rectified over magnesia.

Acetic ether is colourless and clear like water. It has an agreeable smell, a specific gravity of 0.9072, and boils at 77 $\frac{1}{2}$ ° C. It is soluble in 8 parts of water of 0° C., but rather less soluble in water of 15° C. Perfectly pure acetic ether is neutral and very stable. If it contains water it tends to decompose and to

become acid. This circumstance and its high boiling-point lessen its suitability for the manufacture of smokeless powders, since non-liability to become acid and easy evaporation of the solvent are important factors in making them.

### 29. NITRIC ACID.

Nitric acid is manufactured on a large scale by distilling a mixture of nitrate of soda and sulphuric acid, when the following reaction takes place—

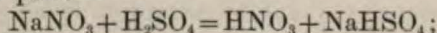

or, in other words, one part of pure sodium nitrate and 1.153 parts of monohydrated sulphuric acid yield 0.741 part of monohydrated nitric acid.

The sodium nitrate used is of varying purity according to the conditions the nitric acid is to fulfil. In most cases it is desirable to obtain nitric acid as free as possible from chlorine and hyponitric acid, and therefore nitrate of soda with a minimum percentage of sodium chloride is used. Good nitrate of soda contains between 0.3 and 0.7 per cent. of sodium chloride, and in general about 96½ per cent. of pure sodium nitrate. According to the strength of the nitric acid required, the sulphuric acid used is of various degrees of concentration. If the highest concentrated nitric acid is required, the nitrate of soda used must first be thoroughly dried and the sulphuric acid must contain at least 96 per cent. of monohydrate.

In America they sometimes go so far as to melt nitrate in pots and cast it into cakes in order to have it quite free from moisture, but as a rule it is sufficient to dry it to ½ per cent. of moisture by the waste heat of the stills. For weaker acids, for instance, nitric acid of 1.420 specific gravity as used for making nitrobenzene, the nitrate need not be dried, and ordinary chamber acid can be used. With good distilling and condensing apparatus, sulphuric acid of 1.530 specific gravity is sufficient for making nitric acid of about 1.380 specific gravity.

By mixing nitrate of soda and sulphuric acid considerable heat is evolved, but it is not sufficient to maintain the reaction. Artificial heat has therefore to be applied, by means of a direct fire round cast-iron distilling vessels, as a rule. In this way it may happen that the mixture is locally heated, mostly at the walls of the vessel, to a higher degree than it should be. In this case another reaction takes place, namely:—

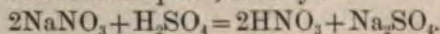

On comparing the two formulæ, it would appear that the most advantageous proportion for charging is 0.576 part of sulphuric acid monohydrate to one part of sodium nitrate. This is not so, because with such proportions the temperature would remain nearly constant at 257° F., until about half of the total nitric acid present was distilled off. The acid sulphate produced would then have to act further on the nitrate which remained undecomposed, and for this so high a temperature would be required that a great amount of the nitric acid would be transformed into nitrous acid. At the same time neutral sodium sulphate would remain as a residue in the still in the form of a hard cake, whilst the iron still would also be actively attacked. Since in practice the convenience of having a liquid residue outweighs the increased cost of sulphuric acid required to get it, it is usual to aim at such proportions between the sulphuric acid and the nitrate that an acid sulphate residue will be chiefly obtained. Therefore, about equal weights of sodium nitrate and sulphuric acid are as a rule taken. In some places an excess of sulphuric acid monohydrate up to 8 per cent. is even taken. This will give for each part by weight of nitrate of soda either 1.083 parts of sulphuric acid of 1.840 specific gravity, or 1.656 parts of 1.530 specific gravity; these proportions are, however, frequently changed for various reasons. Sometimes, for instance, only 1.333 parts of acid of 1.563 specific gravity are used, instead of 1.575 parts as would correspond to the above proportions.

For most purposes pure acid can be obtained by using the above proportions, although it will always contain a little hyponitric acid. Since a greater heat is required for making strong acid, or when the charge is to be distilled off in a short time, it is clear that the acid will in both these cases contain more hyponitric acid than under other circumstances.

There is only one metal that is thoroughly suitable for the construction of stills for distilling nitric acid, and that is cast-iron. Almost all other metals are rapidly attacked by nitric acid, or are too expensive for their use to be practicable. Earthenware would be very suitable, but it is hardly possible to make vessels of sufficient size for working on a large scale, and with the least want of precaution they would crack. The production of a cast-iron mixture capable of resisting for as long a period as possible the attacks of the various acids is a constant study with ironfounders who make this kind of apparatus, and it is still an open question what mixture of cast-iron is best for nitric acid. It is, however,

quite clear that the cast-iron should be homogeneous, and free from blow-holes or included slag. The skin should not be removed, since it is less rapidly attacked than the iron under it. Almost every foundry has a mixture of its own, but good hematite iron, with a small percentage of "white" pig-iron, is probably the best. Chips and scraps should not be used for the mixture, because they tend to produce slags.

A suitable mixture of iron is an important factor in the life of a still; some are eaten through in less than a year, and some after being at work for twenty years are still without any

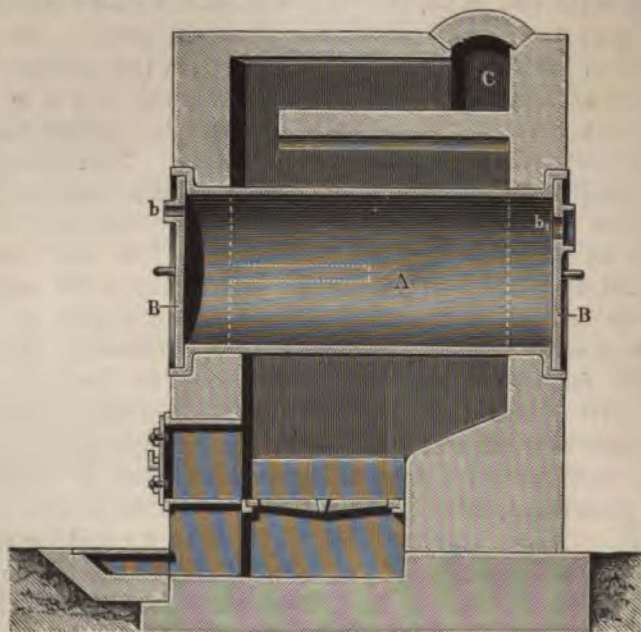

FIG. 45.—One-40th full size.

signs of wear. Some parts of the still are more quickly attacked than others. Probably the most rapid wear takes place on the covers of the stills, or on the ends of cylinders, which is to be ascribed chiefly to the cooling and condensation of the acid vapours on these parts.

The apparatus for distilling nitric acid can be divided into two groups: cylinders and stills. The most frequently used, especially for weaker nitric acid, is the cylinder which is shown in Fig. 45, and also in Figs. 63 and 64. Sometimes the cylinder stands by itself, sometimes with a second one in the same



furnace; but frequently a long row of them placed side by side are surrounded by brickwork. As a rule, the cylinder apparatus consists of a cast-iron cylinder (A) of 2 feet 4 inches to 3 feet diameter, and 5 to 6 feet long, the thickness of metal being from  $1\frac{1}{2}$  to 2 inches. It is shaped at the ends into the form of a socket to receive the covers (B). Sometimes, but rarely, the

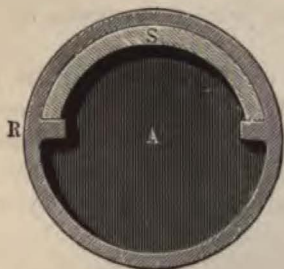

FIG. 46.—One-40th full size.



FIG. 47.—One-40th full size.

cylinder is cast with one end solid, but as a rule both ends can be taken off. Sometimes flagstones are used, but generally cast-iron covers (B), having sockets (b and b<sub>1</sub>) at their upper parts, one for introducing the sulphuric acid, and the other for carrying away the acid vapours to the condenser.

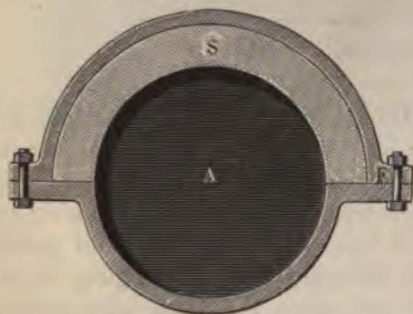

FIG. 48.—One-40th full size.

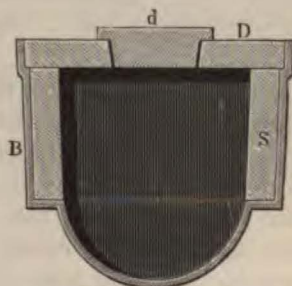

FIG. 49.—One-40th full size.

The apparatus is charged with nitrate by removing a cover, and the nitre cake is discharged in the same way. After charging, the cover is placed in and luted with clay. As shown in the figure, the fire passes round the lower part of the cylinder, and from there into a main flue (c). Sometimes the cylinders have a rib (as at R, in Fig. 46) cast on to their upper half, on which

a lining to the upper half of the cylinder of acid-proof stones (s) rests. In order to have the whole area of the circle available, the upper half is sometimes of a larger diameter than the lower one, and is connected by means of a flat portion (f, Fig. 47), so that the internal radius of the brickwork on the upper half is the same as the lower unlined half. Sometimes the cylinder is made in two halves (as shown in Fig. 48), and the upper half lined with bricks. The two parts are jointed by means of bolts and a sheet of asbestos.

The cylinder is a very good form of distilling apparatus, as it allows the fire to play round it freely on all sides, and therefore no acid can condense on the upper half. If, notwithstanding this, it is in time attacked, the cylinder can be turned through 180°, and a comparatively unattacked part obtained. Cylinders

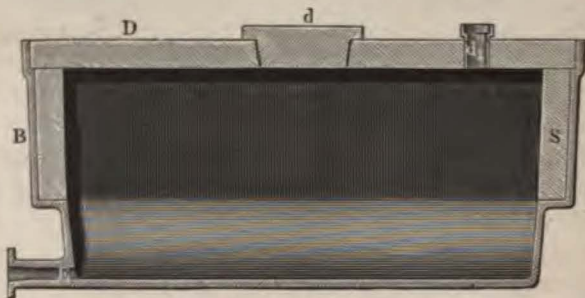

FIG. 50.—One-40th full size.

have the disadvantage that the ends are of necessity exposed to the cooling action of the air, and are therefore attacked readily. In some factories, therefore, they are covered with a protecting composition, and the nitrate introduced through a charging-hole in the cover. On the other hand, the taking off and putting on again of the covers for charging and discharging is very troublesome, and takes time; and since the nitre cake must be first cooled before the cover can be taken off, it has to be broken in the cylinder itself. More recently covers with a discharging-hole for the bi-sulphate, as in Fig. 64, have been used; but such a cylinder is just as difficult to cast as a still, and there is then no longer any reason for using a cylinder, especially as their use is not advantageous when highly concentrated nitric acid is being made. It is quite superfluous to brick-line cylinders, since the whole surface is surrounded by fire, and if the vapour



exit-pipe is placed in a suitable position, condensation cannot easily take place in it. At the same time, even if the bricks are perfectly acid-proof, the mortar in the joints is gradually eaten away, and as soon as there is the least hole, acid vapour will condense between the brickwork and the metal, and the iron will be rapidly attacked. The brickwork is also liable to fall in.

A transitional form of apparatus between the cylinders and stills, which was formerly used in some factories, is shown in

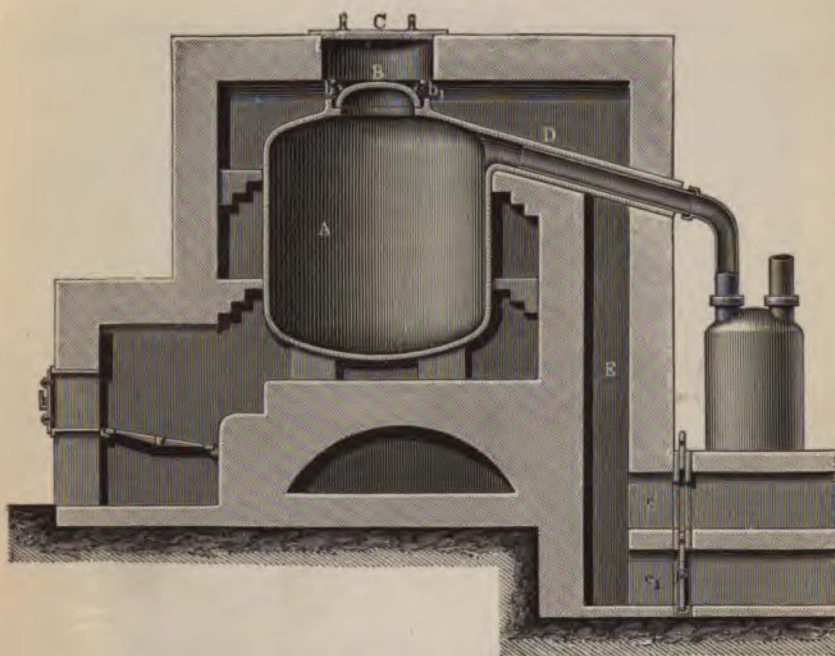

FIG. 51.—One-40th full size.

Figs. 49 and 50. It consists of a lower part (A), which is surmounted by a flat-sided upper part (B). The ends are rounded, so that the whole tank has an oval form. It is lined inside with bricks (s), and has a stone cover (D), in which are the necessary openings for the introduction of nitrate (d), and outlet of gases (d<sub>1</sub>). The setting is arranged so that the lower part is surrounded by fire, while the lower part of the flat sides rests on the brickwork. The outlet (E) is for discharging the bi-sulphate.

Cup-shaped stills have been in use for a very long time,

and although they were probably the first type of distilling apparatus, most primitive forms of them are still to be found. The original form was probably a simple iron pot with a rim cast on it, into which a flagstone with a hole in the centre, through which the gases issued, was placed as a cover. Since the cover is not attacked in such pots, they last a long time, but the flagstone has to be lifted off at each charging. The bi-sulphate

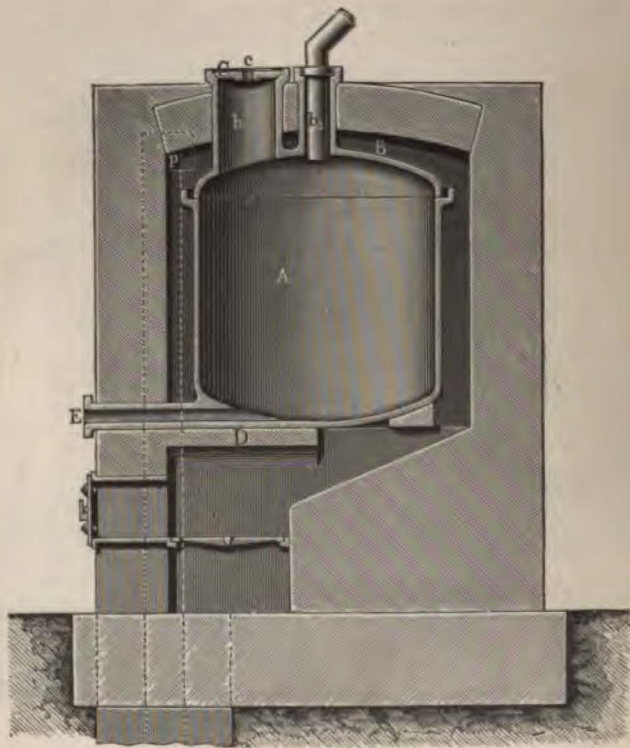

FIG. 52.—One-40th full size.

has to be ladled out, or if by the carelessness of the workmen it has been allowed to get hard, it has to be broken in the pot itself. Another kind of pot is illustrated in Fig. 51. The brick-setting, which is clearly shown in the illustration, allows the fire to play completely around the pot. The pot (A) is closed by the charging-cover (B) with two handles (b), and a second cover (c) above the brickwork. The vapour outlet (D) is sloped downwards on one side. This is a disadvantage, as, if the contents

of the still froth up, bi-sulphate may be carried over into the condensing vessels; moreover, no discharging-hole for the bi-sulphate is provided. At its lower end the flue (E) divides into two branches (e and e<sub>1</sub>), either of which can be connected alternately with the still by means of the damper (F). When the fire-gases pass through the upper one (e), the condensing vessels are first heated so as to prevent their cracking.

A good still for small charges is illustrated in Fig. 52. The cover (B) is loose, and is cemented on in some suitable manner.

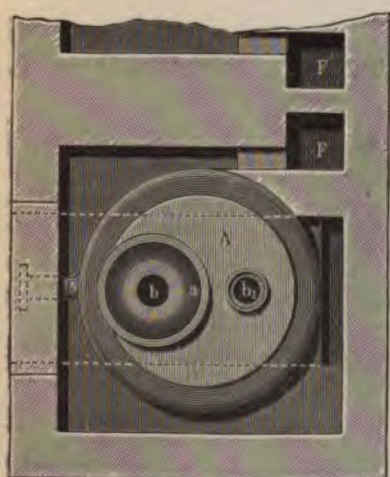

FIG. 53.—One-40th full size.

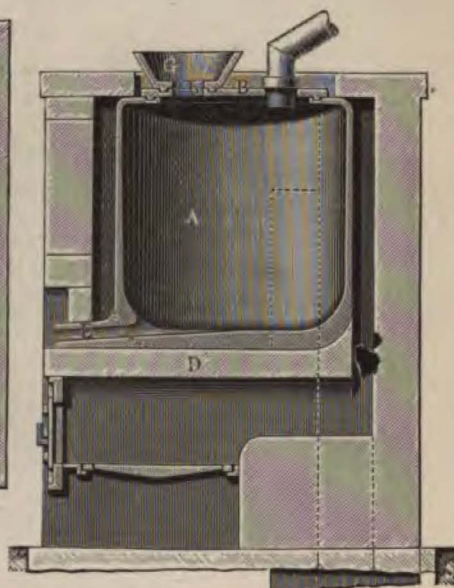

FIG. 54.—One-40th full size.

It has two sockets (b and b<sub>1</sub>), the one (b) for introducing the nitrate, the other (b<sub>1</sub>) for carrying away the vapours distilling off. The charging socket is closed by a cast-iron or stone cover (c), in which there is a small opening (c), through which the sulphuric acid is run in. The still rests on a brick arch (D), and the fire passes from the back of the still upwards, and out at the front by the flue (E). A similar still, long rows of which are used in large factories, is illustrated in Figs. 53 and 54, but the form of the lower part is slightly different. The cover (B) is flat, and simply rests on an internal flange, the joint being made with putty. A rib on the cover fits into a groove in this flange, and



is made tight by asbestos putty. The charging-hopper (c) is fitted to the cover in a similar manner.

For large charges it is not advisable to cast the stills in one piece, as the weight of the still would then be too great for it to be handled conveniently, and also because when part of it is eaten away, the whole still would have to be replaced. Further, there are advantages in working with large stills, since the labour in firing, charging, and discharging is almost as great with small stills as with large ones, and as a rule the condensing apparatus is sufficient to deal with the larger amount of work. On the

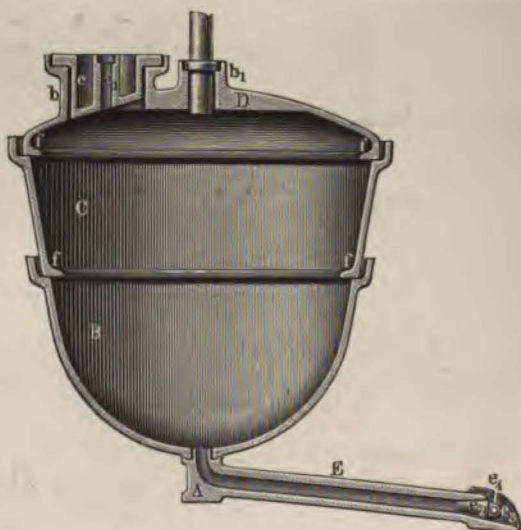

FIG. 55.—One-40th full size.

other hand, there is a certain limit to the capacity of the condensers which has to be considered. Taking all things into consideration, 12 to 14 cwt. of nitrate is about the highest practical limit of a charge. The still must be of larger dimensions than is actually required to contain this quantity, as the upper half of the still should always remain empty, in order to give vapour space and sufficient room for the frothing up of the mass.

A form of still which has been frequently used by the author with very satisfactory results is illustrated in Fig. 55. It consists of a base (A) cast in one with a discharge-pipe (E) for the bisulphate, a hemispherical vessel (B), a conical upper piece (C), and a cover (D). This arrangement is convenient, since it permits easy

bricking-in of the still and replacement of the worn-out parts. In the cover there is a large charging-socket (b) and a vapour-exit socket (b<sub>1</sub>). The charging-hole is closed by means of the plug (e), in which there is a central hole (e<sub>1</sub>) for running in the sulphuric acid. Both the upper section (c) and the cover have an internal flange (f) round their lower edge, the object of which is to turn the contents, when frothing back, towards the centre, and so prevent them from rising. It also prevents any acid condensing on the sides from trickling down by causing it to drip off clear of them. The discharge-pipe (E) is closed by a cast-iron stopper

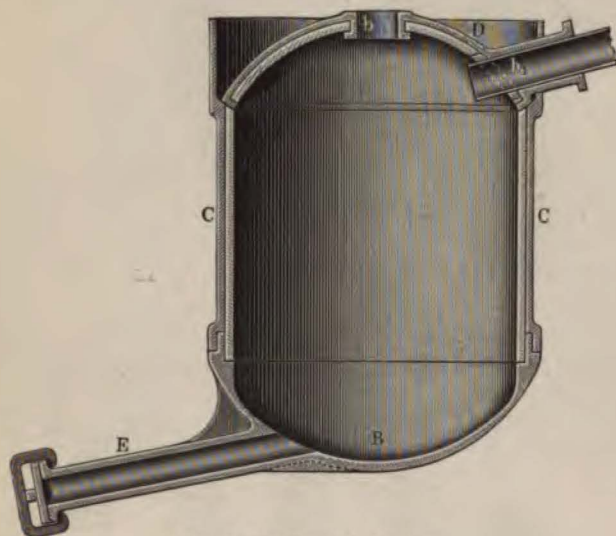

FIG. 56.—One-40th full size.

(e<sub>2</sub>) which is held in position by an iron bar passing through the eye (e<sub>3</sub>) and the slots (e<sub>4</sub>) at the end of the discharge-pipe. The various parts of the still are put together by means of rust joints. The brick-setting is arranged so that the fire plays round the whole of the still, and also over the cover. Wrought-iron plates are put over the cover to close the brick-setting at the top, which thus attains about the same heat as the still. At the same time they serve for drying the nitrate which is spread upon them, and it is thus possible to dry the charge for the next day by what would otherwise be waste heat. It was formerly the practice to line the covers of similar stills with brickwork, but this is not necessary when the fire gases play over the cover.

A similar still, but of rectangular form, is used in a factory in Austria. Another form, illustrated in Fig. 56, has been designed by Mr. Walter F. Reid, the peculiarity of which is that the whole of its vertical parts and the cover are lined with flagstones. The

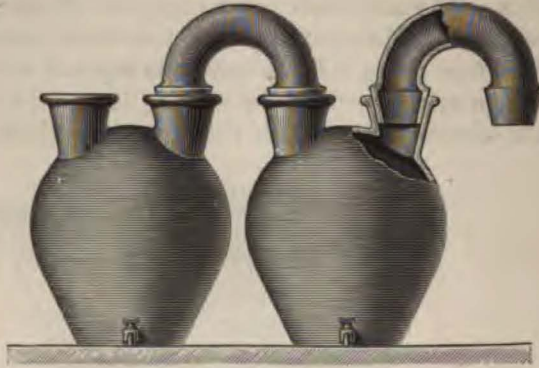

FIG. 57.—One-25th full size.

separate parts of the still are made tight by means of asbestos rings.

For the condensation of nitric acid, it is hardly possible to use anything but earthenware and glass apparatus. The ordinary

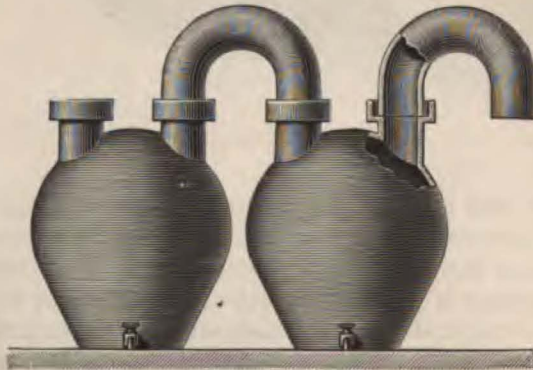

FIG. 58.—One-25th full size.

earthenware receivers, which are still largely used, were probably the earliest form of condenser employed for this purpose. They are simply Woolf bottles, with or without a tap at the bottom, and are connected with each other by means of bends. Formerly



they had conical sockets, into which the ends of the bends, which were also conical, were ground, as in Fig. 57. Later on, the form illustrated in Fig. 58 was adopted, and it is the form now generally used. The bends as a rule are jointed with asbestos putty, or sometimes with clay. The disadvantages of receivers are that they require a very large amount of space, and that a large number of them is required to condense a given quantity of gas. Their cooling power depends upon the surface in contact with the acid vapours, and as there is always a certain quantity of hot acid remaining in the receivers, part of the surface is not

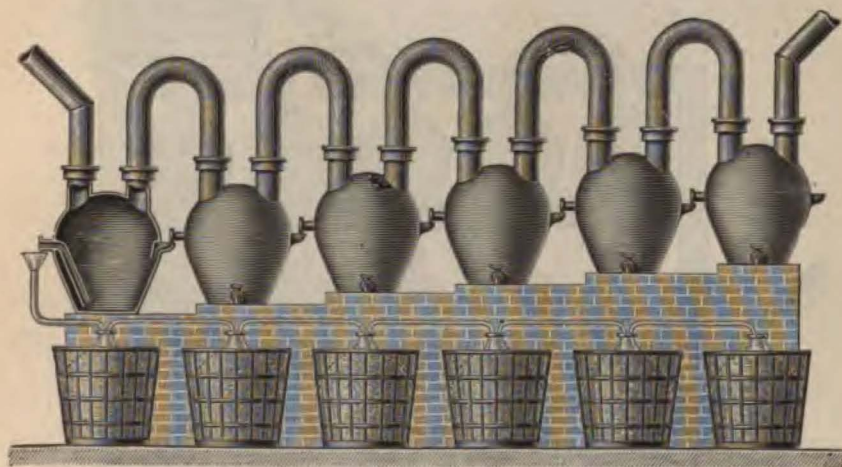

FIG. 59.—One-50th full size.

available for cooling. Another disadvantage is that the acid, being in constant contact with the vapour, absorbs all impurities in it.

The receivers are sometimes arranged in steps, and each of them has an inlet on the side and an outlet tube reaching to the bottom, so that the acid of the first receiver gradually runs into the lower ones, and finally issues from the last one. Fig. 59 shows such an arrangement, and also the manner in which the acid is automatically conveyed into glass carboys by means of glass syphons inserted in them.

A better system of condensation is that of Plisson and Devers (Fig. 60), which is still to be found in some old factories. A number of bulb-shaped vessels (A) are built up in columns. The condensed acid first runs into a special receiver (B), and is collected by itself. The uncondensed gas passes gradually through

several systems of balloons, the last of which ( $A_1$ ) is filled with pieces of coke, and any gases which escape from this, uncondensed, pass into a cooling-worm ( $C$ ).

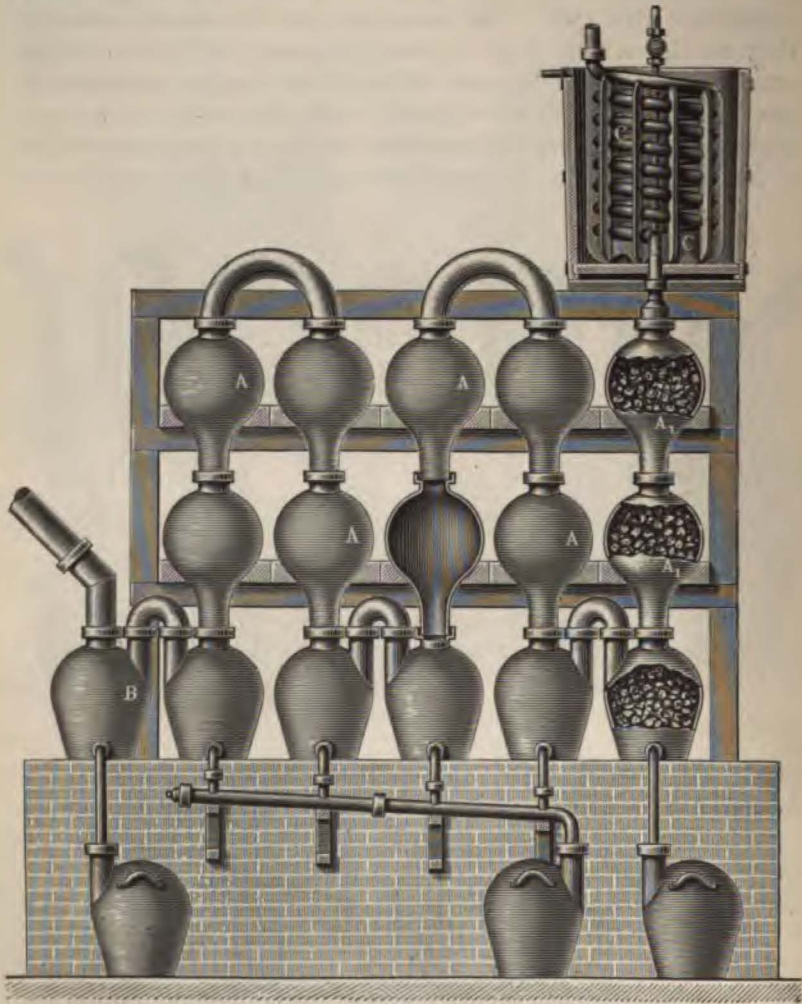

FIG. 60.—One-40th full size.

Marchal improved upon this system. His arrangement is shown in Figs. 61 and 62. It consists of a number of receivers with conical bottoms, which are connected with each other by means of straight pipes and bends. The outlet at the lowest



part of each receiver is fitted with a liquid seal (Fig. 62), so that the acid condensing in the receivers constantly runs out. Each seal is connected with a main acid pipe which leads to a collector. By means of this the whole of the acid produced is of the same strength.

Another means of condensation formerly used were earthenware cooling-worms, which stood in tubs through which cold water ran continuously, and in which the whole or part of the acid was condensed. Sometimes these worms were made of corrugated tubes

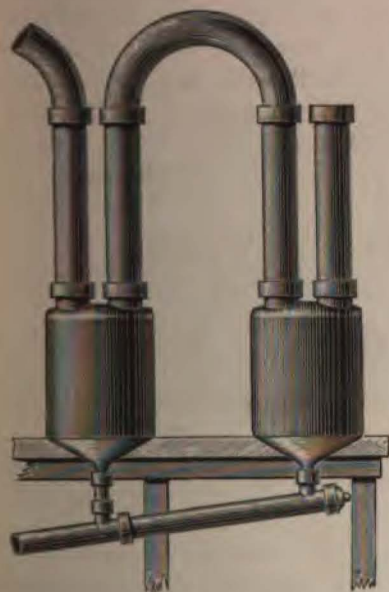

FIG. 61.—One-40th full size.

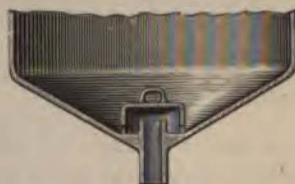

FIG. 62.—One-15th full size.

to increase the cooling surface. The readiness with which they crack under continuous changes of temperature is a great and unavoidable disadvantage. Unless made from very good material, they are also easily broken. The chief objection, however, to these cooling-worms is that the gases enter them at the top and are never completely condensed, so that the draught is impaired and the distillation retarded. In any case all impurities are absorbed by the acid and all water vapour condensed with it, so that a weaker and less pure acid is produced with them.

The chemical factory of Griesheim have patented a process for the manufacture of purified nitric acid, a plan of the

apparatus for which is shown in Fig. 63 and a section in Fig. 64. It has the usual cylinder (A) for distilling, the construction of which can be readily seen from the drawing. To this is connected an intermediate vessel (B), in which the nitric acid is condensed, and through which compressed air is blown. This bleaches the acid already formed by driving off the nitrous acid and the halogens. The nitrous acid which is mixed with the air is condensed in the cooling-worms (D) in the form of nitric acid. This runs back into the intermediate vessel, whilst the halogen compounds escape through the pipe (E). The purified acid in the intermediate vessel runs into the collector (F), and the gases which have not condensed in it are further cooled in the receiver (G), and, finally, the few uncondensed

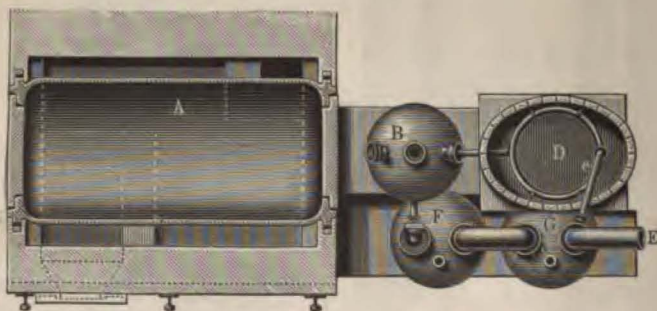

FIG. 63.—One-60th full size.

traces escape through the chimney. It is said that this apparatus produces very good acid with a high percentage of monohydrate, but a large quantity of weaker acid must be obtained with it at the same time.

The process patented by Dr. F. Valentiner, of Leipsic, for the manufacture of pure nitric acid, the apparatus for which is illustrated in Fig. 65, deviates from the usual process only in so far that the nitric acid is distilled under a partial vacuum. The nitric acid is distilled in the still (A), which is provided with a man-hole (a) and sight-window (b). The vapour distilling over passes first through a cooling-worm (B), and then through a number of receivers, in which it condenses. Between these receivers and the air-pump (D), two air-vessels (E) are inserted, by means of which it is possible to keep a vacuum in one apparatus, whilst the second one is being emptied. There are, further, two washing-bottles (F)

filled with soda solution inserted between these air-vessels and the air-pump, in order to prevent even traces of the vapours from passing to the pump. The inlet to the first receiver (C<sub>1</sub>) is controlled by a three-way tap (c), in order to separate the weak acid passing over at the beginning from the rest. By this process part

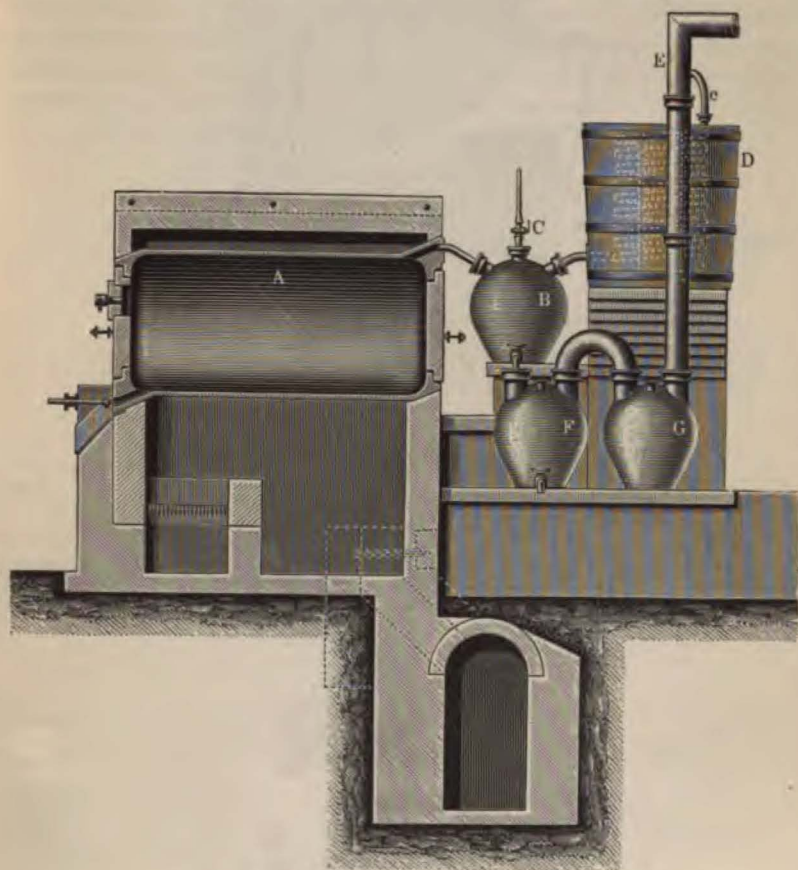

FIG. 64.—One-60th full size.

of the acid is said to be obtained of extraordinary strength, even up to 99.5 per cent.  $\text{HNO}_3$ , and the time of distillation is said to be so reduced by the vacuum that three charges per day can be worked. The maintenance of this apparatus in working order, however, will most probably be very troublesome.

Mr. Manning Prentice, of Stowmarket, has patented an apparatus



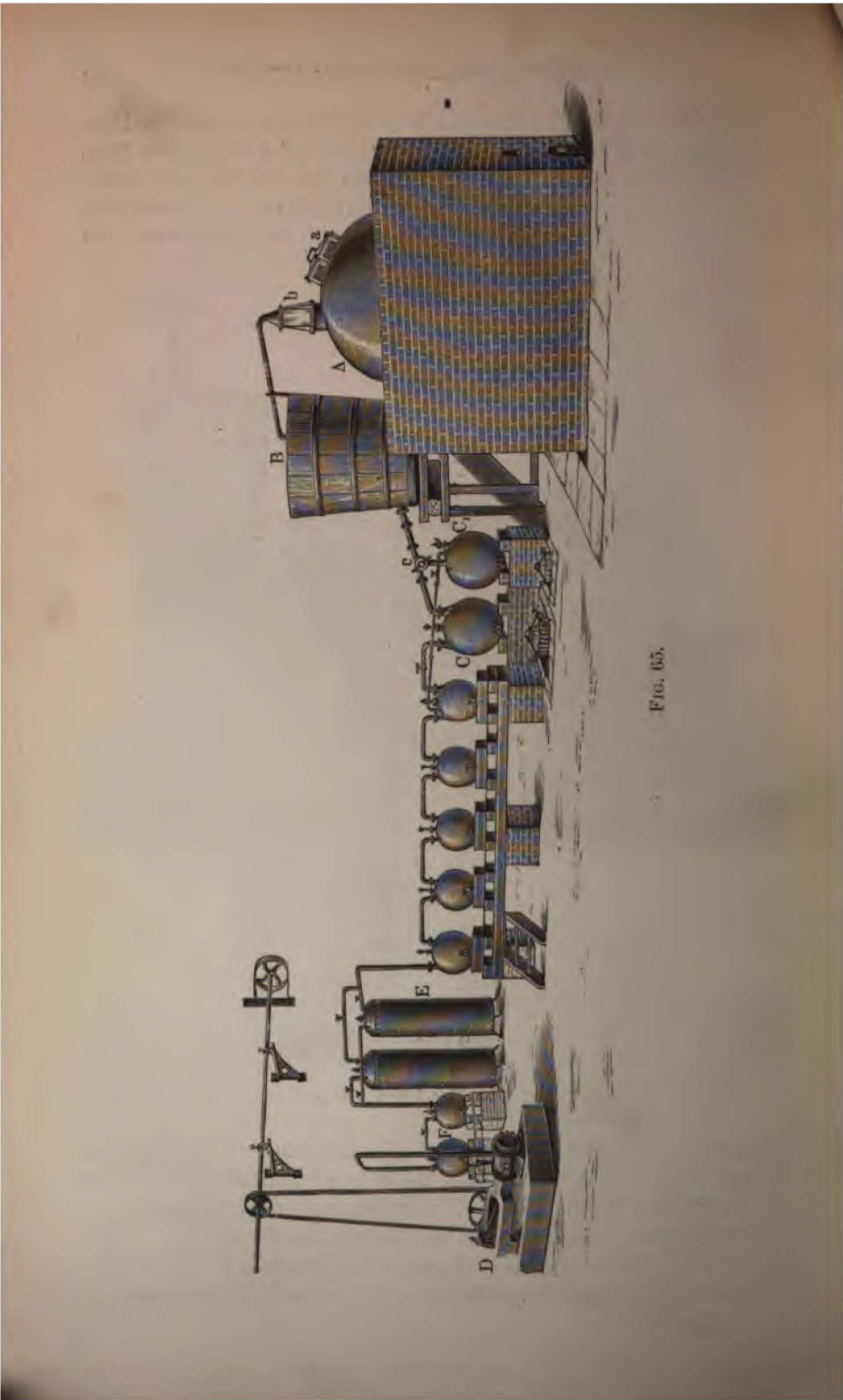

FIG. 65.

for the continuous manufacture of nitric acid. It consists of an oblong cast-iron trough (A, Fig. 66), which is divided into several compartments by means of partitions (b). Over each of these compartments a pyramidal cover (B) with gas-pipes (c) is fitted, in such a manner that the partition of the compartment makes a tight joint with the cover. The partition is perforated at the bottom, so that the liquid can circulate from one compartment to another, but not the gases. At the front of the apparatus an inlet socket (E) is cast on, into which are introduced, by means of a feed-arrangement, nitrate, in the form of powder, and sulphuric acid. The feeding-arrangement consists of a hopper (F), and a screw-

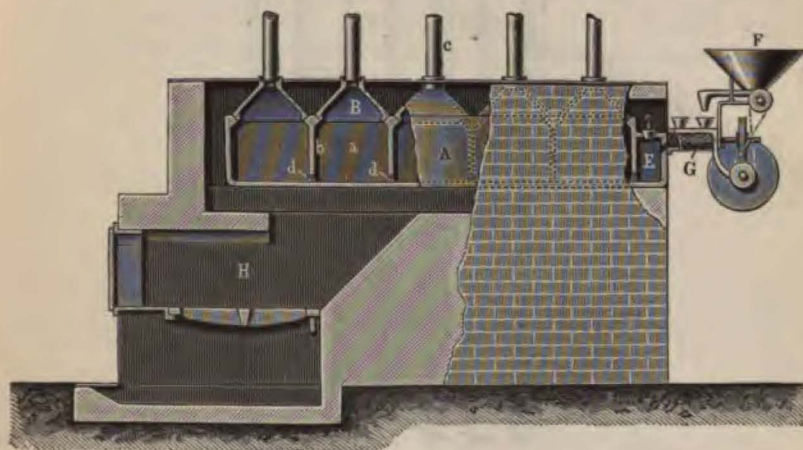

FIG. 66.—One-48th full size.

conveyer (G). Sulphuric acid and nitrate enter into it, and are mixed inside by the screw-conveyer, which feeds them into the apparatus in the form of a thin paste. At the lower end of the apparatus a discharge-socket for bi-sulphate is provided, being placed sufficiently high to always maintain a certain level of liquid within the apparatus. The gas-pipes on the covers lead to ordinary condensing batteries consisting of stoneware receivers. The whole apparatus is set in a furnace (H), which is provided with a fire-grate and bridge, and the products of combustion pass all round the apparatus and over the covers. The author has seen this apparatus at work, and found that continuous work is really done by it. The bi-sulphate discharged is practically free from nitric acid. In order to keep the charge continually

liquid, and to prevent the caking of neutral sulphate, an excess of at least 20 per cent. of sulphuric acid is required. The nitric acid formed varies in strength to a still greater degree than is the case with intermittent distillation, this depending on whether it comes from a compartment nearer or further from the fire-end of the apparatus, but the acid produced is very pure. The apparatus has no special advantage over ordinary apparatus for the manufacture of highly-concentrated nitric acid, except when at the

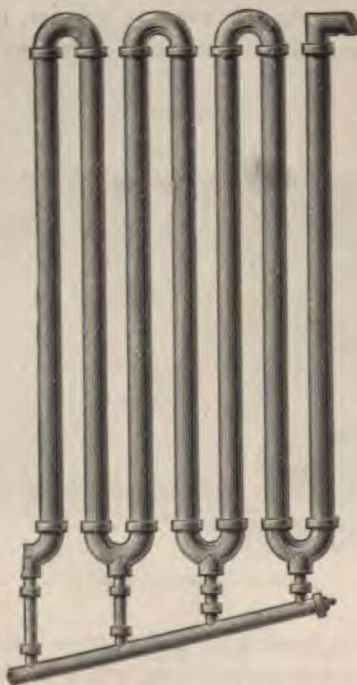

FIG. 67.—One-40th full size.

same time the manufacture of super-phosphate manure can be carried on, as the necessity for a large excess of sulphuric acid outweighs by far the advantages of continuous working. On the other hand, it is quite possible to let the bi-sulphate run direct into ground phosphates, with the addition of water if necessary, and to work the mixture into manure in a mixing-machine. Such manure, however, will probably find a very limited use, since it will contain a good deal of sodium sulphate.

As before mentioned, receivers have the disadvantage that

the condensation only takes place on the walls, and the contents of the vessels must of necessity be excessively large in proportion to the cooling surface. Starting from this fact, and supported by the excellent quality and workmanship of the apparatus made by Ludwig Rohrmann at Krauschwitz, in Germany, the author was led to use long earthenware pipes exclusively, for condensation. At the same time he considered that the condensation of nitric acid in fractions is in most cases undesirable, and that the separate drawing off of acid from a number of receivers is for many reasons inconvenient, chiefly because that with bad work a highly concentrated acid is obtained from one receiver and a very weak one, sometimes below 1.150 specific gravity, from others. Although manufacturers selling different strengths of acids may find it desirable to get the various degrees of concentration direct

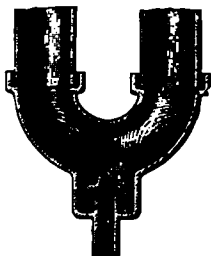

FIG. 68.—One-15th full size.

from their receivers, nevertheless the mixing of the acids and bringing them to uniform strength requires much labour and testing. Marchal had a similar idea when he made a main discharge-pipe in constructing his battery.

Originally the author also used a similar arrangement. Figs. 67 and 68 show the original form of the Guttman condensing battery. It consisted of a series of pipes about 4 feet 4 inches long and 4 inches bore, connected alternately on the top and bottom by means of special bends. The construction of these is shown on an enlarged scale in Fig. 68. The drain-pipes were connected with the main discharge-pipe by means of small socket-pipes. This arrangement was rather liable to breakage, and was especially inconvenient on account of the number of joints it entailed. The author later on designed a modified form of this battery in which a so-called "chamber-pipe" took the place of the numerous connecting bends.



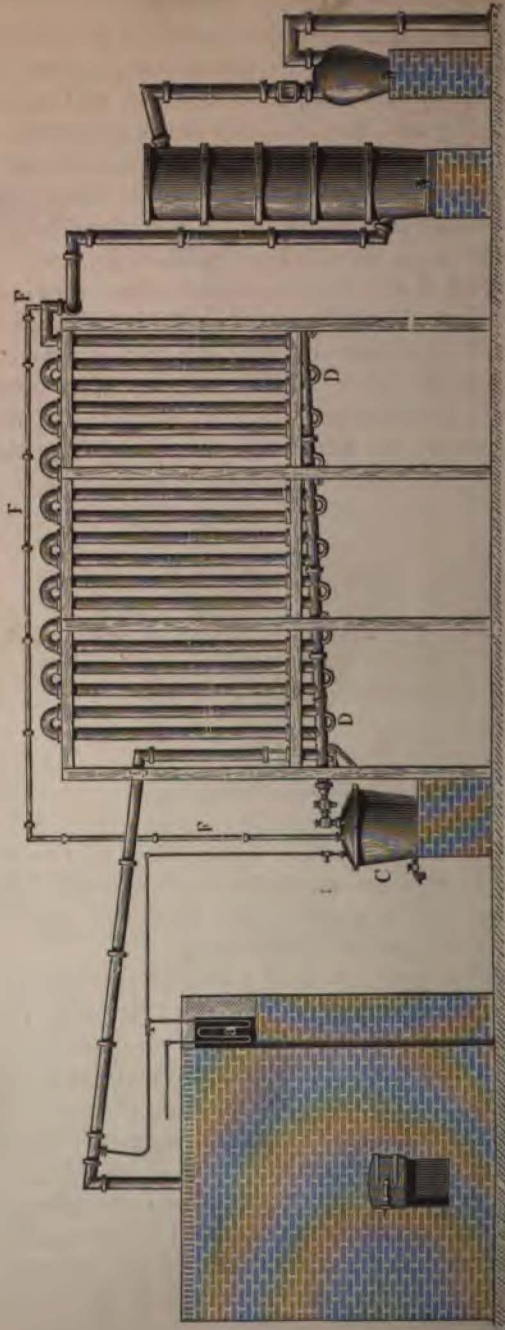

FIG. 69. — One-80th full size.

Fig. 69 shows the whole arrangement of nitric acid plant on this system, and in Fig. 70 the section of the chamber-pipe is shown to an enlarged scale. The chamber-pipe (A) is a long pipe which is set on a slope, it is of 4 inches bore, and has sockets at suitable distances, the height of which constantly increases, so that the upper parts of the sockets are all at one level. Partitions (C) cross the chamber-pipe between each two sockets, and so divide it into a number of compartments, each provided with two sockets. Each of these chambers is connected by means of a small bend (D) with the next chamber, and the whole forms a pipe burnt in one piece, which is very durable. As can be seen from Fig. 69, the acid runs without interruption from one end of the chamber-pipe to the other, so that only the small bends (D) are constantly filled with acid, whilst the pipe itself is empty. The non-condensed gases have thereby free passage from one pipe to another by

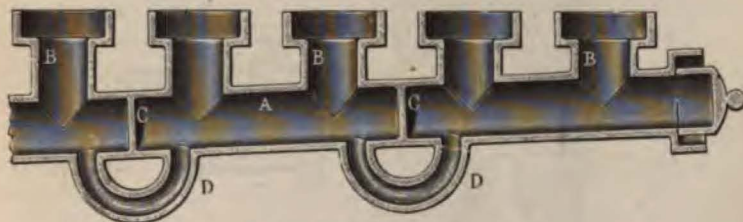

FIG. 70.—One-15th full size.

means of the upper elbows. The chamber-pipe is closed at one end by means of a cap, and at the lower end has a T-piece provided with two taps, one of which serves for drawing samples, whilst the other leads into a collecting vessel (C). The gas issuing from the acid contained in the collector passes through a pipe-line (F) to a condensing-tower. The whole battery is mounted in a wooden framework, to which the chamber-pipe is secured near the sockets by means of iron straps. It is at the same time supported on several rollers. The vertical tubes are held at the top by iron clamps which, whilst they prevent lateral motion, allow the pipes to expand freely as they become hot.

This process of condensation is specially intended for use when the distillation is conducted at high temperatures. With it the gases passing through the condensing battery are not allowed to fall below a certain minimum temperature, in order that the hyponitric acid developed, and the chlorine liberated in the still, shall be

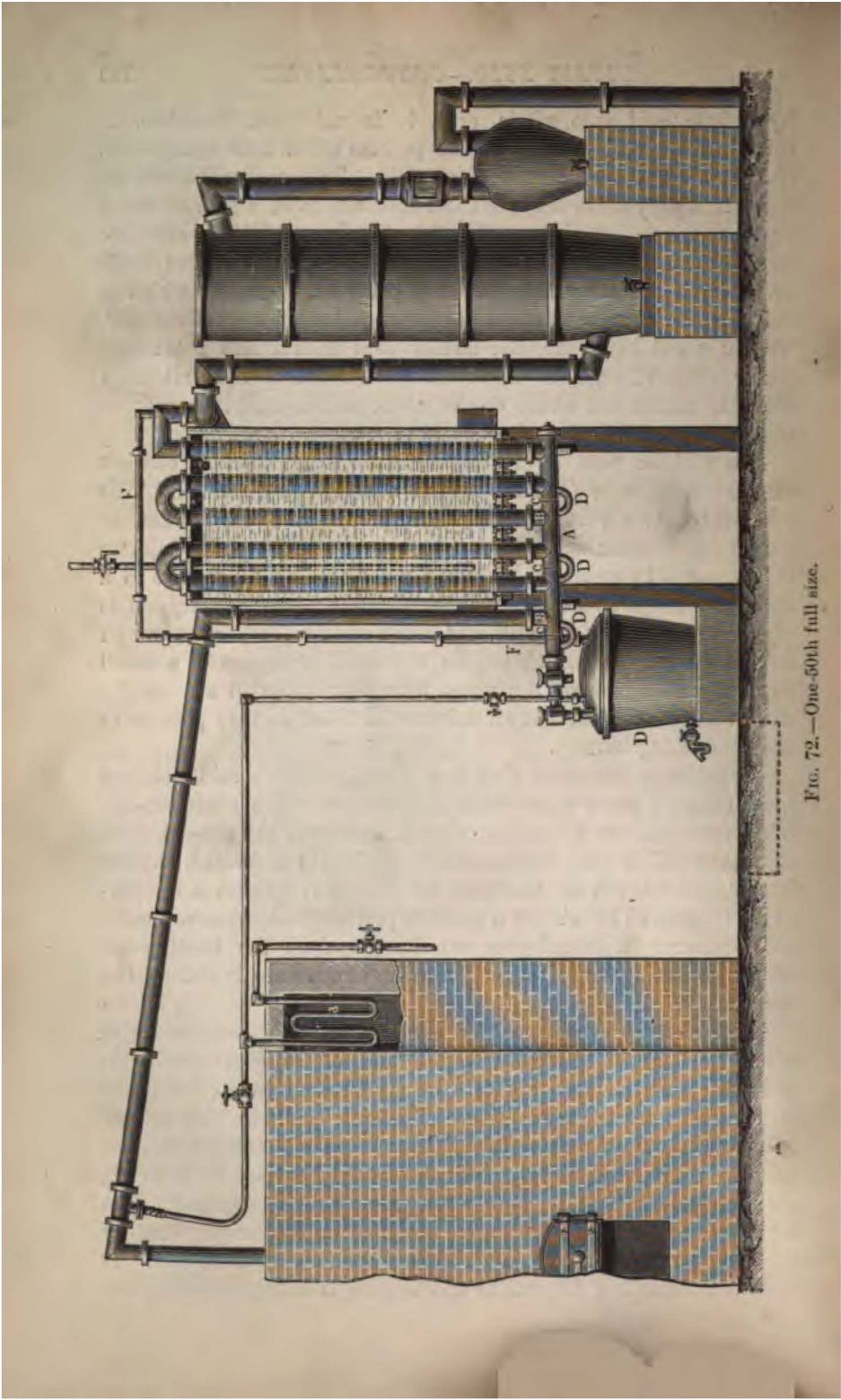

FIG. 72.—One-50th full size.



hyponitric acid into nitric acid, it is sufficient, therefore, to introduce air and water, but the process often lasts many days if cold air be blown in the nitric acid. This conversion can be done in a very short time, if the nitric acid is in a gaseous state and hot air is introduced. In this case, the addition of water in the form of steam is superfluous, since nitric acid as made on a large scale contains about 5 per cent. of water, which is sufficient to convert a much larger quantity of hyponitric acid. To carry out this plan, the author uses Rohrmann's patent injector (Fig. 71), placed immediately in front of the exit from the still, where the whole of the nitric acid is still in a gaseous state.

As will be seen from the illustration, the injector consists of a straight tube (A), into which a nozzle (B) is fixed. This consists of two parts ( $b$  and  $b_1$ ) inserted into each other, so that a fine annular space ( $c$ ) is left between them. This injector is connected by means of a short piece of india-rubber hose to a small wrought-iron heating-coil (a, Fig. 69). The heating-coil is placed in the flue of the still, and compressed air is blown through it, the quantity of which can be regulated by means of a small tap. By this injector the gases formed in the still are rapidly drawn away, and the hot air mixes with them as they pass on to the condensing battery.

Experience has shown that in this manner nitric acid, with not more than 0.7 per cent. of hyponitric acid, and at a concentration of 97 per cent., can be made during the whole of the process. The more the still is fired, the more hyponitric acid is formed, but the hotter also will the air become. In general it reaches a temperature of about 176° F. If a product perfectly colourless or nearly so be desired, a branch-pipe can be run from the heating-coil to the collecting vessel, and air also be blown into it during the distillation.

For certain purposes, as, for instance, for the manufacture of nitric acid as highly concentrated and of as great purity as possible; for the recovery of nitric acid from waste acids by denitrating; for the manufacture of arsenic acid, etc., this battery is specially suitable, since in all three cases a prolonged contact of acid, steam, and air is required. Such a battery is, however, rather costly to instal where weak nitric acid is required. The author, therefore, has recently designed a condensing battery cooled by water, which has given exceptionally good results. It is illustrated in Fig. 72, and, as will be seen, is simply a Guttman-

Nitric acid does not come over from the stills in a uniform stream, but, as Hart observed, in several stages, this can be explained from the equations given above for the formation of nitric acid. At the beginning the reaction between the sulphuric acid and nitrate is very violent, and the distillation must therefore be started very slowly, as otherwise bi-sulphate would be carried over into the condensing apparatus, and the development of gases become more rapid than the condensing apparatus could deal with. As soon as the formation of solid neutral sulphate begins, the distillation stops for a moment, beginning again violently when a stronger heat is applied. The distillation must therefore be carefully regulated. The duration of distillation may vary. For a charge of about 12 cwt., it is as a rule between 24 and 36 hours. It is not at all difficult to finish a distillation in 6 hours, provided the condensing apparatus are sufficiently large, but with such rapid distillation the corrosion of the iron vessels

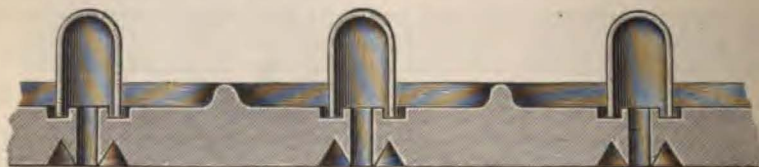

FIG. 77.—One-half full size.

is of necessity great and the acid produced is very impure. With the stills and batteries designed by the author, which are described above, the time of distillation is reduced to between 12 and 14 hours.

The quality of acid varies according to the still and condensing apparatus. As mentioned above, when using ordinary receiver condensing batteries and dried nitrate of high percentage and sulphuric acid of 96 per cent., the strength of acid obtained varies between 1.260 and 1.510 specific gravity. With the Guttman battery the whole of the acid made is of between 95 and 96 per cent. of monohydrate, and only that part of the acid which is condensed in the tower is of about 1.380 specific gravity.

The quantitative yield is about the same in all well-conducted factories. As previously mentioned, theoretically 74.13 parts of nitric acid monohydrate can be made from 100 parts of pure sodium nitrate. As a rule about 95 per cent. of this are condensed in the batteries and about 5 per cent. pass to the tower.



Bohrmann battery, with six pipes only. Of these five are in a wooden tank filled with water, whilst the sixth, which is connected with the still, is outside, and is therefore cooled by air alone. The fixing of the pipes in the tank is very simple: at the top the sockets rest on a board through which the pipes pass, and at the lower end they pass through the bottom of the tank, the joints here being made water-tight by means of rubber rings squeezed between iron flanges. The arrangement of collectors, injectors, and heating-coils, and also of the pipe-line leading to the tower, are the same as in the case of the air-condensing battery. With this apparatus all the acid can be obtained at a strength of 96 per cent. monohydrate; but since the condensation is done more rapidly and less time is given for the reaction between the air and steam, the acid made in it will always contain slightly over 1 per cent. of hyponitric acid. This, however, is still low enough to be considered favourable in most factories.

As a matter of course, no system of condensation is perfect, and the stronger the acid manufactured the more gases will escape uncondensed from the batteries. This is not only a direct loss, but a nuisance to the neighbourhood, and in some countries the maximum amount of acid allowed by law to escape into the air is very small. In Great Britain it is below four grains per cube foot of sulphuric acid, and practically no nitric acid. It is therefore desirable to condense as much of the gas as possible. A very simple means would be to pass them through burnt lime, and to use the nitrate of lime thus formed. Mr. W. F. Reid, according to a communication he has made to the author, formerly tried charging stills with nitrate of lime, but it led occasionally to a very violent stormy evolution of gas, which caused much damage. Repeated attempts have been made, especially with the Plisson and Devers system, to effect the condensation of the final trace of gas in a column filled with broken pumice stone or coke, over which water was allowed to run. If the water runs through in sufficiently large quantities the gases are completely absorbed, but when the water is only slightly acid, it cannot be used further, and is just as big a nuisance as the unabsorbed gases, since it attacks the soil and pollutes rivers. Nevertheless, suitably constructed coke towers (Fig. 73) have been gradually introduced where a small escape of gas is not objected to, and by carefully regulating the water running down them, acid of about 1.260 specific gravity can be obtained, which is suitable for some uses. Such towers are built up of earthenware cylinders (A) with sockets (a<sub>1</sub>). As a rule, they

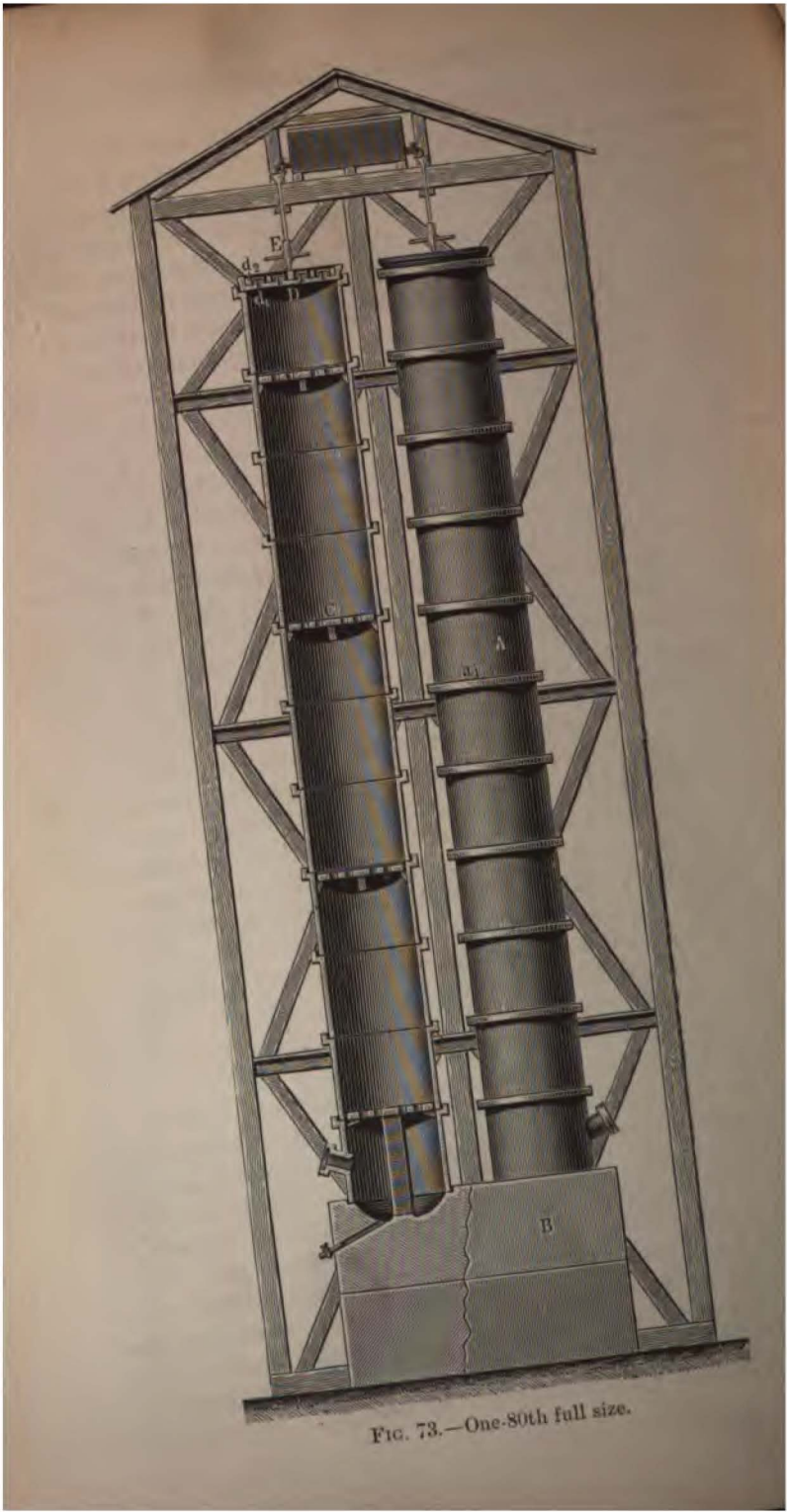

FIG. 73.—One-80th full size.



stand on a base block (B), and in about every third cylinder a perforated plate (c) is placed to relieve the weight of the coke. It is supported by a suitable framework in such a manner that the entire weight of the tower does not come on the base, and that the whole is easily accessible. On the top is a cover (D) in which there are a number of perforations ( $d_1$ ) covered with caps ( $d_2$ ), forming a water-lute over each. In the centre of the cover is a Segner reaction wheel (E), which is fed from a water-tank in the roof, and as it revolves distributes the water evenly over the cover.

These towers have a number of serious disadvantages. The

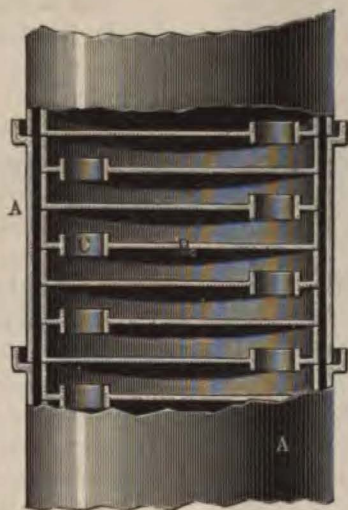

FIG. 74.—One-20th full size.

coke is attacked by the nitric acid, and gradually decomposes the latter. By and by the coke settles into a dense mass, and its surface, which when newly introduced is rough and consequently very large, becomes smaller and smaller. The water gradually forms small channels through which it flows down almost without hindrance, and without moistening the coke itself to any extent. In this way the capacity of such coke towers is diminished. If acid of some strength is to be obtained in such a tower, it must be made very high; and in fact the tower here illustrated, which is 45 feet high and 3 feet in diameter, is only sufficient for a factory using about three tons of nitrate per day.



FIG. 75.

Although coke towers on account of their simplicity are not costly, yet the framework required, including steps and boarding for protection from wind and weather, makes them in the end fairly expensive. Attempts have therefore been made to adapt the column system to the construction of such towers, and in Fig. 74 one of these is illustrated. It consists of a number of cylindrical pipes (A), like those used with coke towers; into these dishes (B) with the lipped openings (c) are placed alternately to the right and left. It will readily be seen that the acid will rise in these dishes until it overflows through the openings (c); a certain height of liquid is therefore always maintained on the dishes, and the gases passing over the liquid are gradually absorbed by it.

A much more perfect tower has been designed by Dr. George Lunge, which is known as the Lunge-Rohrman plate-tower. It is illustrated in Fig. 75 (also Figs. 69 and 72). The gas enters into the lowest section, from which the acid formed is run off through a tap. The bottom piece also serves, if

required, as a collector for acid. On this bottom piece stand a suitable number of intermediate cylinders (B), and on the top of them a top section (C). A number of plates ( $b_1$ ) are placed one on top of the other in these intermediate cylinders with earthenware distance rings ( $b_2$ ) between them. The surface of each plate is divided into a number of squares by means of small ribs running across, and in each square there is a perforation. Altogether there are 1200 holes in each plate. Round each hole is a lip (Fig. 76), so that a thin layer of acid stands on the plate. The plates are so made that the holes of one plate stand opposite the solid parts of another, by which means acid dropping through the holes in one plate is divided into a spray by striking the next plate below. In this way a fine cloud of minute drops is formed between the plates, and the gases are forced to pass through this cloud, and over the layer of acid on the plate. This causes a very perfect absorption of gases to take place, and the tower illustrated

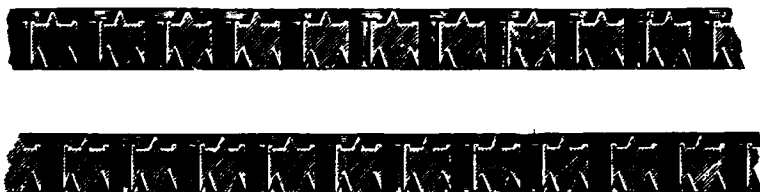
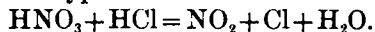

Fig. 76.—One-half full size.

here, which is only 10 feet high, has about the same capacity as the coke tower of 45 feet height shown in Fig. 73. About half the uppermost cylinder is left free, so that the uncondensed gas can pass through a branch pipe into a receiver, and from there to the chimney. The colour of the gas, and from this the action of the tower, can be seen through a lantern (Figs. 69 and 72). The lantern is fitted with small plugs by means of which the draught can be regulated at will. The top section is closed by a cover (Fig. 77), the holes in which are made gas-tight by caps forming water-lutes. Although in other cases it is convenient to run the water on by means of a Segner reaction wheel, or better still by means of a distributor, when making nitric acid it is much more advantageous to let the water run on to the tower in a very thin thread which with correct dimensions of the tower is sufficient to absorb the gases, yielding acid of 1.400 specific gravity. The tower rests on a dressed stone ring about 4 inches thick and 4 inches high, which in turn rests on a brick pier.

The percentage of hyponitric acid varies according to the purity of the nitrate used and the working of the stills.

The chlorine contained in the nitrate forms hydrochloric acid with the sulphuric acid, and this decomposes the nitric acid already formed into hyponitric acid and chlorine.



Thus each 1 per cent. of sodium chloride causes a loss of 1.453 per cent. of sodium nitrate, and forms 1.573 per cent. of nitrous acid, 0.607 per cent. of chlorine, and 0.308 per cent. of water. Upon heating strongly, nitric acid also decomposes into hyponitric acid and water. Thus the chlorine contained in the nitrate and excessive heating dilute the acid.

In commercial nitric acid only a very small quantity of hyponitric acid is tolerated, sometimes none at all, but in factories making nitric acid for their own purposes, so much stress is not laid upon the absence of hyponitric acid. It will be seen that opinions are divided as to what percentage of hyponitric acid is allowable. There have been dynamite factories of the first rank which have used nitric acid containing as much as 7 per cent. of hyponitric acid, whilst others insist on its not being above  $\frac{1}{2}$  per cent. The conditions justifying these two extremes will be referred to later. In general it may be said that a larger quantity than 2 per cent. is undesirable.

Nitric acid should contain a minimum of chlorine, and no sulphates at all. The latter will only get into the nitric acid when the distillation is hurried, or when the exit-pipe of the still bends down too suddenly, or when distillation is carried too far at the finish and sulphuric acid distilled over. Should the latter be the case, it is then better to have some arrangement as in the Guttman-Rohrmann battery, by which the inlet to the collector can be shut off, and the mixture of sulphuric and nitric acids, which may still come over, be collected separately and used again with another charge.

The bi-sulphate remaining as a residue in the still is either allowed to cool and then broken out, or it is discharged from the still in a liquid state and run into flat cast-iron vessels, or into pits lined with cast-iron plates. If the bi-sulphate is not more than 8 inches thick in these pits, it can be broken, after cooling, into irregular cubes by dropping a wedge-shaped iron bar on to it. On examining the bi-sulphate it can easily be ascertained whether the distillation was complete or whether some nitric acid has been left in the bi-sulphate.

Nitric acid is usually more or less discoloured by hyponitric acid, and varies from a light yellow to a brownish-red. It can be perfectly bleached by heating and passing a current of air through it. For this purpose a bleaching apparatus, such as is illustrated in Fig. 78, may be used. A large earthenware receiver (A) is placed in a wooden box forming a water-jacket (B) round it, which is heated by means of steam. An air-pipe is put into the receiver,

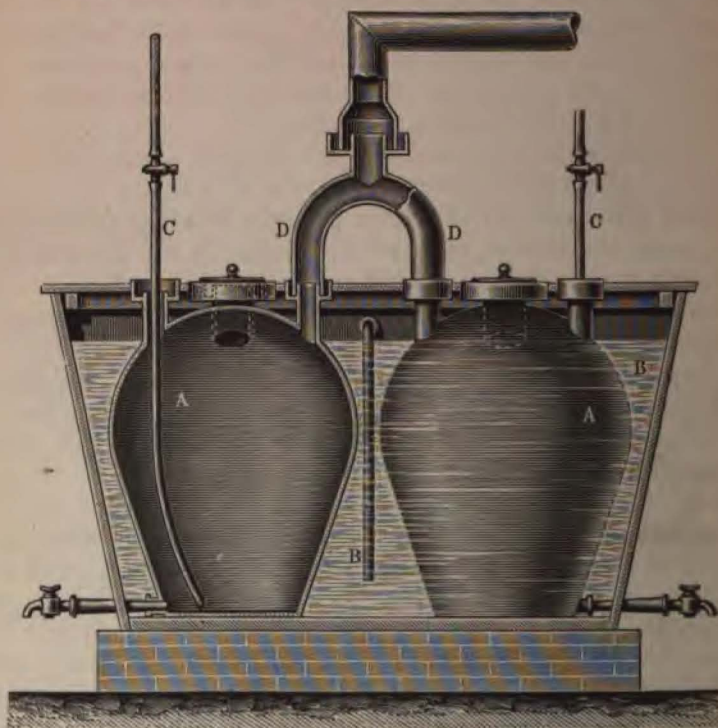

FIG. 78.—One-25th full size.

while a gas discharge-pipe (D) carries the chlorine and the vapours of hyponitric acid and nitric acid developed, away to the tower. The bleached acid is drawn off by means of a tap passing to the outside of the wooden box.

The operation of bleaching lasts about forty-eight hours. It can be done much more quickly if a current of hot compressed air is passed through the nitric acid. For this purpose an iron or copper coil is put into a flue and the air for bleaching passed through it. This always weakens the acid a little.



If nitric acid containing hyponitric acid is diluted with water, it becomes green, the colour being darker the more hyponitric acid there is present. The green colour is due to the formation of nitro-sulphonic acid (chamber crystals) which dissolve in the acid.

The erection of pottery and cylinders requires some attention. To make a tight joint in iron apparatus, an asbestos mill-board, or, better still, a rust-joint is sufficient. A good cement for the rust-joints consists of 99 parts of sifted cast-iron borings to one part of ammonium chloride (sal ammoniac) made into a paste with vinegar or urine. The cement is put into the cavities in layers of about  $\frac{3}{8}$  inch thick at a time, and each well caulked. After about twenty-four hours it will as a rule have set quite hard.

Pottery joints can be made by means of clay or one of the various cements in common use. The best joint, according to the author's experience, is made with a cement composed of silicate of sodium and asbestos powder, in the following manner:— 1 part of silicate of sodium is dissolved in 19 parts of water, and fine asbestos powder is mixed with it in small quantities at a time, the mass being constantly kneaded until a tough paste is obtained, which will break without sticking. Should a cement be required which will become very hard, a little finely-powdered barium sulphate should be mixed with it, but as a rule this is not desirable, since, if pipes have to be changed, the cement cannot be removed without risk of damaging them. The proportion of silicate of sodium and water is of importance, since otherwise the water absorbed by the cement will cause it to swell and burst the sockets.

The cement is put into the sockets in small bits, and tightly pressed in by means of a piece of wood with a blunt end. The surface should then be made flat, and it is well to moisten it a little with some sodium silicate solution. The same putty is well adapted for mending cracks in pottery. To do this the cracked place must be carefully cleaned, moistened with a little sodium silicate solution, and a thick roll of putty then carefully laid on and allowed to harden for twenty-four hours. On account of the heating and cooling of the pottery the putty in the socket shrinks, and in time the joints become leaky and allow disagreeable escapes of gas to occur in the factory. It is therefore advisable to carefully rake out about  $\frac{3}{8}$  inch of the top of the cement in such

sockets as are liable to leak and to put on a fresh layer about once a week. If this is carefully done for a few weeks, no further trouble will arise from the joints.

The consumption of coal varies between rather wide limits according to the system of distillation employed, and the manner of working the stills. As a rule it is about half-a-pound of best coal for each pound of nitrate taken, or about three-quarters of a pound for each pound of nitric acid monohydrate produced. With good stills and condensing apparatus the consumption has been reduced to 0.16 and 0.25 lb. respectively. It is not at all necessary however to use the best kinds of coal for firing. Lignite and peat have been found very serviceable, and since workmen have always a tendency to keep their grates full of fuel, and also since it is not advisable to distil too fast, it is best to use such a fuel that will allow of easy control, and therefore sometimes an inferior fuel is preferable.

The quantity of bi-sulphate varies according to the manner of working the still. On an average it amounts to 1.2 lbs. to each pound of nitrate used. It will be rarely possible to make use of the bi-sulphate. Sometimes it is sold to manure-makers, who use it as an addition to manure. Sometimes crystallized glauber salt is made from it by means of quicklime. In some cases, where a hydrochloric acid factory is connected with the establishment, it is used exclusively, or as an addition, for the manufacture of sodium sulphate.

Nitric acid is best stored in glass carboys or earthenware vessels, which should be previously weighed, and to which, after they are filled with nitric acid, a small wooden label, on which the weight of the full and empty vessel is marked, should be attached. The carboys should not be tightly closed, but loosely covered with an earthenware or, better still, with a glass cover in the form of a hollow cap fitting over the neck, which is sufficient to protect it against the action of the moisture of the air, and at the same time allows free egress for any gases which may develop. It is a good plan to dip the straw in which the carboys are packed in a solution of zinc chloride, or bi-sulphate, to render it incombustible. The upper part of the glass carboys should be lime-washed in the summer, because direct sunlight gradually decomposes nitric acid. The manner of storing the carboys is of importance; it is advisable to place them in rows of two abreast on low-lying or excavated ground, and to leave about 2 feet of space between



each row, so that in the event of one carboy bursting the others can easily be taken out of the way. Both at Avigliana and Angoulême very extensive fires have arisen from unsuitable storage. Carboys may be moved about by inserting into the baskets two iron bars, or gas-pipes, which are carried by a workman at each end, or on special trolleys.

Pure nitric acid is colourless. If it contain the least trace of hyponitric acid it becomes yellowish, and as the percentage increases the colour approaches more and more to a dark red. It is a strong oxidizer, fumes in contact with the air, and has a peculiar pungent odour. Even pure nitric acid changes its colour when exposed to sunlight, because the latter decomposes part of it into hyponitric acid and water. As a rule, the oxidizing action of nitric acid takes place in the cold, but it is increased by heating. Most organic substances are oxidized by it, animal tissues becoming of a yellow colour under its action, metals, with the exception of gold, platinum, rhodium, and iridium, are dissolved by it, nitric oxide being at the same time evolved. Cast-iron assumes the so-called passive state when placed in highly concentrated nitric acid, and is not attacked in the cold, but it is attacked when hot, probably because the very dilute vapours containing nitrous acid act upon it as they condense. On dissolving zinc in nitric acid, no hydrogen is developed, but nitric acid is reduced to ammonia. A mixture of nitric and hydrochloric acids forms the well-known "aqua-regia," which, on account of it containing free chlorine, dissolves gold and platinum. Arsenious and some other acids are more highly oxidized by nitric acid. Arsenic acid is made on a large scale in this way.

The chief use for nitric acid is in the manufacture of nitro-compounds from various organic substances, in which atoms of hydrogen are replaced by nitroxyl molecules. This reaction is utilized in the manufacture of nitro-benzene, nitro-glycerin, gun-cotton, nitro-naphthalene, picric acid, tri-nitro-cresol, and the whole army of nitro-compounds produced in the coal-tar industry. Some of the compounds contain one, two, or more nitroxyl molecules according to variations in the process by which they are made, and mono-, di-, tri-, etc., nitro-compounds are respectively obtained.

The boiling-point of nitric acid varies according to the quantity of water it contains. Pure nitric acid boils at 86° C. The following table shows the various boiling-points of acids of different degrees of strength:—

## SPECIFIC GRAVITY.

1.52  
1.50  
1.48  
1.42  
1.40  
1.35  
1.30  
1.20  
1.15

## BOILING-POINT.

86° C.  
99°  
115°  
123°  
119°  
117°  
113°  
108°  
104°

The determination of the boiling-point of nitric acid is attended with considerable difficulties. The thermometer must be held in the vapours of the nitric acid, and as near as possible to the surface of the liquid. The reading must be taken at the moment the first bubble appears, as the temperature still continues to rise after this point on account of the continuous decomposition of nitric acid, until a nearly constant temperature of 123° C. is reached.

The percentage of nitric acid of various specific gravities, at a temperature of 15° referred to water at 4° in vacuo, has been determined by Lunge and Rey in a series of most careful and troublesome experiments, and can be seen from the following table:—

SPECIFIC GRAVITIES AT 15° (IN VACUO).	DEGREES BAUMÉ.	DEGREES TWADDELL.	100 PARTS BY WEIGHT CONTAIN					1 LITRE CONTAINS KILOGRAMMES				
			N <sub>2</sub> O <sub>5</sub> .	HNO <sub>3</sub> .	Acid of 36° B.	Acid of 40° B.	Acid of 48½° B.	N <sub>2</sub> O <sub>5</sub> .	HNO <sub>3</sub> .	Acid of 36° B.	Acid of 40° B.	Acid of 48½° B.
1.000	0	0	0.08	0.10	0.19	0.16	0.10	0.001	0.001	0.002	0.002	0.001
1.005	0.7	1	0.85	1.00	1.89	1.61	1.03	0.008	0.010	0.019	0.016	0.010
1.010	1.4	2	1.62	1.90	3.60	3.07	1.95	0.016	0.019	0.036	0.031	0.019
1.015	2.1	3	2.39	2.80	5.30	4.52	2.87	0.024	0.028	0.053	0.045	0.029
1.020	2.7	4	3.17	3.70	7.01	5.98	3.79	0.033	0.038	0.072	0.061	0.039
1.025	3.4	5	3.94	4.60	8.71	7.43	4.72	0.040	0.047	0.089	0.076	0.048
1.030	4.1	6	4.71	5.50	10.42	8.88	5.64	0.049	0.057	0.108	0.092	0.058
1.035	4.7	7	5.47	6.38	12.08	10.30	6.54	0.057	0.066	0.125	0.107	0.068
1.040	5.4	8	6.22	7.26	13.75	11.72	7.45	0.064	0.075	0.142	0.121	0.077
1.045	6.0	9	6.97	8.13	15.40	13.13	8.34	0.073	0.085	0.161	0.137	0.087
1.050	6.7	10	7.71	8.99	17.03	14.52	9.22	0.081	0.094	0.178	0.152	0.096
1.055	7.4	11	8.43	9.84	18.64	15.89	10.09	0.089	0.104	0.197	0.168	0.107
1.060	8.0	12	9.15	10.68	20.23	17.25	10.95	0.097	0.113	0.214	0.182	0.116
1.065	8.7	13	9.87	11.51	21.80	18.59	11.81	0.105	0.123	0.233	0.198	0.126
1.070	9.4	14	10.57	12.33	23.35	19.91	12.65	0.113	0.132	0.250	0.213	0.135
1.075	10.0	15	11.27	13.15	24.91	21.24	13.49	0.121	0.141	0.267	0.228	0.145
1.080	10.6	16	11.96	13.95	26.42	22.53	14.31	0.129	0.151	0.286	0.244	0.155
1.085	11.2	17	12.64	14.74	27.92	23.80	15.12	0.137	0.160	0.303	0.258	0.164
1.090	11.9	18	13.31	15.53	29.41	25.08	15.93	0.145	0.169	0.320	0.273	0.173

NITRIC ACID.—PERCENTAGE TABLE

SPECIFIC GRAVITIES AT 15° (IN VACUO).			100 PARTS BY WEIGHT CONTAIN					1 LITRE CONTAINS KILOGRAMMES				
	DEGREES BAUMÉ.	DEGREES TWADDELL.	N <sub>2</sub> O <sub>5</sub>	HNO <sub>3</sub>	Acid of 36° B.	Acid of 40° B.	Acid of 43½° B.	N <sub>2</sub> O <sub>5</sub>	HNO <sub>3</sub>	Acid of 36° B.	Acid of 40° B.	Acid of 43½° B.
1.095	12.4	19	13.99	16.32	30.91	26.35	16.74	0.153	0.179	0.339	0.289	0.184
1.100	13.0	20	14.67	17.11	32.41	27.63	17.55	0.161	0.188	0.356	0.304	0.193
1.105	13.6	21	15.34	17.89	33.89	28.89	18.35	0.170	0.198	0.375	0.320	0.203
1.110	14.2	22	16.00	18.67	35.36	30.15	19.15	0.177	0.207	0.392	0.335	0.212
1.115	14.9	23	16.67	19.45	36.84	31.41	19.95	0.186	0.217	0.411	0.350	0.223
1.120	15.4	24	17.34	20.23	38.31	32.67	20.75	0.195	0.227	0.430	0.366	0.233
1.125	16.0	25	18.00	21.00	39.77	33.91	21.54	0.202	0.236	0.447	0.381	0.242
1.130	16.5	26	18.66	21.77	41.23	35.16	22.33	0.211	0.246	0.466	0.397	0.252
1.135	17.1	27	19.32	22.54	42.69	36.40	23.12	0.219	0.256	0.485	0.413	0.263
1.140	17.7	28	19.98	23.31	44.15	37.65	23.91	0.228	0.266	0.504	0.430	0.273
1.145	18.3	29	20.64	24.08	45.61	38.89	24.70	0.237	0.276	0.523	0.446	0.283
1.150	18.8	30	21.29	24.84	47.05	40.12	25.48	0.245	0.286	0.542	0.462	0.293
1.155	19.3	31	21.94	25.60	48.49	41.35	26.26	0.254	0.296	0.561	0.478	0.304
1.160	19.8	32	22.60	26.36	49.92	42.57	27.04	0.262	0.306	0.580	0.494	0.314
1.165	20.3	33	23.25	27.12	51.36	43.80	27.82	0.271	0.316	0.598	0.510	0.324
1.170	20.9	34	23.90	27.88	52.80	45.03	28.59	0.279	0.326	0.617	0.526	0.334
1.175	21.4	35	24.54	28.63	54.22	46.24	29.36	0.288	0.336	0.636	0.543	0.345
1.180	22.0	36	25.18	29.38	55.64	47.45	30.13	0.297	0.347	0.657	0.560	0.356
1.185	22.5	37	25.83	30.13	57.07	48.66	30.90	0.306	0.357	0.676	0.577	0.366
1.190	23.0	38	26.47	30.88	58.49	49.87	31.67	0.315	0.367	0.695	0.593	0.376
1.195	23.5	39	27.10	31.62	59.89	51.07	32.43	0.324	0.378	0.715	0.610	0.388
1.200	24.0	40	27.74	32.36	61.29	52.26	33.19	0.333	0.388	0.735	0.627	0.398
1.205	24.5	41	28.36	33.09	62.67	53.23	33.94	0.342	0.399	0.755	0.644	0.409
1.210	25.0	42	28.99	33.82	64.05	54.21	34.69	0.351	0.409	0.775	0.661	0.419
1.215	25.5	43	29.61	34.55	65.44	55.18	35.44	0.360	0.420	0.795	0.678	0.431
1.220	26.0	44	30.24	35.28	66.82	56.16	36.18	0.369	0.430	0.815	0.695	0.441
1.225	26.4	45	30.88	36.03	68.24	57.64	36.95	0.378	0.441	0.835	0.712	0.452
1.230	26.9	46	31.53	36.78	69.66	59.13	37.72	0.387	0.452	0.856	0.730	0.466
1.235	27.4	47	32.17	37.53	71.08	60.61	38.49	0.397	0.463	0.877	0.748	0.475
1.240	27.9	48	32.82	38.29	72.52	61.84	39.27	0.407	0.475	0.900	0.767	0.487
1.245	28.4	49	33.47	39.05	73.96	63.07	40.05	0.417	0.486	0.921	0.785	0.498
1.250	28.8	50	34.13	39.82	75.42	64.31	40.84	0.427	0.498	0.943	0.804	0.511
1.255	29.3	51	34.78	40.58	76.86	65.54	41.62	0.437	0.509	0.965	0.822	0.522
1.260	29.7	52	35.44	41.34	78.30	66.76	42.40	0.447	0.521	0.987	0.841	0.534
1.265	30.2	53	36.09	42.10	79.74	67.99	43.18	0.457	0.533	1.009	0.860	0.547
1.270	30.6	54	36.75	42.87	81.20	69.23	43.97	0.467	0.544	1.031	0.879	0.558
1.275	31.1	55	37.41	43.64	82.65	70.48	44.76	0.477	0.556	1.054	0.898	0.570
1.280	31.5	56	38.07	44.41	84.11	71.72	45.55	0.487	0.568	1.077	0.918	0.583
1.285	32.0	57	38.73	45.18	85.57	72.96	46.34	0.498	0.581	1.100	0.938	0.596
1.290	32.4	58	39.39	45.95	87.03	74.21	47.13	0.508	0.593	1.123	0.957	0.608
1.295	32.8	59	40.05	46.72	88.48	75.45	47.92	0.519	0.605	1.146	0.977	0.621
1.300	33.3	60	40.71	47.49	89.94	76.70	48.71	0.529	0.617	1.169	0.997	0.633
1.305	33.7	61	41.37	48.26	91.40	77.94	49.50	0.540	0.630	1.193	1.017	0.646
1.310	34.2	62	42.06	49.07	92.94	79.25	50.33	0.551	0.643	1.218	1.038	0.659
1.315	34.6	63	42.76	49.89	94.49	80.57	51.17	0.562	0.656	1.243	1.059	0.673
1.320	35.0	64	43.47	50.71	96.05	81.90	52.01	0.573	0.669	1.268	1.080	0.686
1.325	35.4	65	44.17	51.53	97.60	83.22	52.85	0.585	0.683	1.294	1.103	0.701
1.330	35.8	66	44.89	52.37	99.19	84.58	53.71	0.597	0.697	1.320	1.126	0.715
1.3325	36.0	66.5	45.26	52.80	100.0	85.27	54.15	0.603	0.704	1.333	1.137	0.722
1.335	36.2	67	45.62	53.22	100.80	85.95	54.58	0.609	0.710	1.346	1.148	0.728
1.340	36.6	68	46.35	54.07	102.41	87.32	55.46	0.621	0.725	1.373	1.171	0.744
1.345	37.0	69	47.08	54.93	104.04	88.71	56.34	0.633	0.739	1.400	1.193	0.758
1.350	37.4	70	47.82	55.79	105.67	90.10	57.22	0.645	0.753	1.427	1.216	0.772
1.355	37.8	71	48.57	56.68	107.31	91.51	58.11	0.658	0.768	1.455	1.240	0.788
1.360	38.2	72	49.35	57.57	109.03	92.97	59.05	0.671	0.783	1.483	1.265	0.803

SPECIFIC GRAVITIES AT 15° (IN VACUO).	DREIERE BAUMÉ.	DEGREES TWADDLE.	100 PARTS BY WEIGHT CONTAIN					1 LITRE CONTAINS KILOGRAMME-				
			N <sub>2</sub> O <sub>5</sub> .	HNO <sub>3</sub> .	Acid of 36° B.	Acid of 40° B.	Acid of 48½° B.	N <sub>2</sub> O <sub>5</sub> .	HNO <sub>3</sub> .	Acid of 36° B.	Acid of 40° B.	Acid of 48½° B.
1.365	38.6	73	50.13	58.48	110.75	94.44	59.98	0.684	0.798	1.513	1.289	0.818
1.370	39.0	74	50.91	59.39	112.48	95.91	60.91	0.698	0.814	1.543	1.314	0.835
1.375	39.4	75	51.69	60.30	114.20	97.38	61.85	0.711	0.829	1.573	1.339	0.850
1.380	39.8	76	52.52	61.27	116.04	98.95	62.84	0.725	0.846	1.603	1.366	0.868
1.3833	40.0	—	53.08	61.92	117.27	100.00	63.51	0.735	0.857	1.623	1.383	0.879
1.385	40.1	77	53.35	62.24	117.88	100.51	63.84	0.739	0.862	1.633	1.392	0.884
1.390	40.5	78	54.20	63.23	119.75	102.12	64.85	0.753	0.879	1.665	1.420	0.902
1.395	40.8	79	55.07	64.25	121.68	103.76	65.90	0.768	0.896	1.697	1.447	0.919
1.400	41.2	80	55.97	65.30	123.67	105.46	66.97	0.783	0.914	1.731	1.476	0.937
1.405	41.6	81	56.92	66.40	125.75	107.24	68.10	0.800	0.933	1.767	1.507	0.957
1.410	42.0	82	57.86	67.50	127.84	109.01	69.23	0.816	0.952	1.803	1.537	0.976
1.415	42.3	83	58.83	68.63	129.98	110.84	70.39	0.832	0.971	1.839	1.568	0.996
1.420	42.7	84	59.83	69.80	132.19	112.73	71.59	0.849	0.991	1.877	1.600	1.016
1.425	43.1	85	60.84	70.98	134.43	114.63	72.80	0.867	1.011	1.915	1.633	1.037
1.430	43.4	86	61.86	72.17	136.68	116.55	74.02	0.885	1.032	1.955	1.667	1.058
1.435	43.8	87	62.91	73.39	138.99	118.52	75.27	0.903	1.053	1.995	1.701	1.080
1.440	44.1	88	64.01	74.68	141.44	120.61	76.59	0.921	1.075	2.037	1.736	1.103
1.445	44.4	89	65.13	75.98	143.90	122.71	77.93	0.941	1.098	2.080	1.773	1.126
1.450	44.8	90	66.24	77.28	146.36	124.81	79.26	0.961	1.121	2.123	1.810	1.150
1.455	45.1	91	67.38	78.60	148.86	126.94	80.62	0.981	1.144	2.167	1.848	1.173
1.460	45.4	92	68.56	79.98	151.47	129.17	82.03	1.001	1.168	2.212	1.886	1.198
1.465	45.8	93	69.79	81.42	154.20	131.49	83.51	1.023	1.193	2.259	1.927	1.224
1.470	46.1	94	71.06	82.90	157.00	133.88	85.03	1.045	1.219	2.309	1.969	1.250
1.475	46.4	95	72.39	84.45	159.94	136.39	86.62	1.068	1.246	2.360	2.012	1.278
1.480	46.8	96	73.76	86.05	162.97	138.97	88.26	1.092	1.274	2.413	2.058	1.307
1.485	47.1	97	75.18	87.70	166.09	141.63	89.95	1.116	1.302	2.466	2.103	1.335
1.490	47.4	98	76.80	89.60	169.69	144.70	91.90	1.144	1.335	2.528	2.156	1.369
1.495	47.8	99	78.52	91.60	173.48	147.93	93.95	1.174	1.369	2.593	2.211	1.404
1.500	48.1	100	80.65	94.09	178.19	151.96	96.50	1.210	1.411	2.672	2.278	1.447
1.501	—	—	81.09	94.60	179.16	152.78	97.03	1.217	1.420	2.689	2.293	1.456
1.502	—	—	81.50	95.08	180.07	153.55	97.52	1.224	1.428	2.704	2.306	1.465
1.503	—	—	81.91	95.55	180.96	154.31	98.00	1.231	1.436	2.720	2.319	1.473
1.504	—	—	82.29	96.00	181.81	155.04	98.46	1.238	1.444	2.735	2.332	1.481
1.505	48.4	101	82.63	96.39	182.55	155.67	98.86	1.244	1.451	2.748	2.343	1.488
1.506	—	—	82.94	96.76	183.25	156.27	99.27	1.249	1.457	2.759	2.353	1.494
1.507	—	—	83.26	97.13	183.95	156.86	99.62	1.255	1.464	2.773	2.364	1.502
1.508	48.5	—	83.58	97.50	184.65	157.47	100.00	1.260	1.470	2.784	2.374	1.508
1.509	—	—	83.87	97.84	185.30	158.01	100.35	1.265	1.476	2.795	2.384	1.514
1.510	48.7	102	84.09	98.10	185.79	158.43	100.62	1.270	1.481	2.805	2.392	1.519
1.511	—	—	84.28	98.32	186.21	158.79	100.84	1.274	1.486	2.814	2.400	1.524
1.512	—	—	84.46	98.53	186.61	159.13	101.06	1.277	1.490	2.822	2.406	1.528
1.513	—	—	84.63	98.73	186.98	159.45	101.26	1.280	1.494	2.829	2.413	1.532
1.514	—	—	84.78	98.90	187.30	159.72	101.44	1.283	1.497	2.835	2.418	1.535
1.515	49.0	103	84.92	99.07	187.63	160.00	101.61	1.287	1.501	2.843	2.424	1.539
1.516	—	—	85.04	99.21	187.89	160.22	101.75	1.289	1.504	2.848	2.429	1.543
1.517	—	—	85.15	99.34	188.14	160.43	101.89	1.292	1.507	2.854	2.434	1.546
1.518	—	—	85.26	99.46	188.37	160.63	102.01	1.294	1.510	2.860	2.439	1.549
1.519	—	—	85.35	99.57	188.58	160.81	102.12	1.296	1.512	2.864	2.442	1.551
1.520	49.4	104	85.44	99.67	188.77	160.97	102.23	1.299	1.515	2.869	2.447	1.554

The following corrections have to be made for temperatures of a few degrees above and below 15°:—

Specific Gravity.	Correction for $\mp$ 1° C.	Specific Gravity.	Correction for $\mp$ 1° C.
1·000 to 1·020	$\mp$ 0·0001	1·281 to 1·310	$\mp$ 0·0010
1·021 „ 1·040	0·0002	1·311 „ 1·350	0·0011
1·041 „ 1·070	0·0003	1·351 „ 1·365	0·0012
1·071 „ 1·100	0·0004	1·366 „ 1·400	0·0013
1·101 „ 1·130	0·0005	1·401 „ 1·435	0·0014
1·131 „ 1·160	0·0006	1·436 „ 1·490	0·0015
1·161 „ 1·200	0·0007	1·491 „ 1·500	0·0016
1·201 „ 1·245	0·0008	1·501 „ 1·520	0·0017
1·246 „ 1·280	0·0009		

Hyponitric acid considerably increases the specific gravity of nitric acid containing it. Lunge and Marchlewski have carefully examined its influence. It is true they only worked with acid of 1·496 specific gravity, but it can hardly be doubted that the effect on acids of lower strength is in the same proportion. The following table shows the increase of specific gravity caused by hyponitric acid :—

Percentage of $N_2O_4$ .	Alteration of specific gravity due to $N_2O_4$ .	Percentage of $N_2O_4$ .	Alteration of specific gravity due to $N_2O_4$ .	Percentage of $N_2O_4$ .	Alteration of specific gravity due to $N_2O_4$ .
0·25	0·0005	4·50	0·0288	8·75	0·0583
0·50	0·0008	4·75	0·0305	9·00	0·0600
0·75	0·0015	5·00	0·0323	9·25	0·0616
1·00	0·0030	5·25	0·0337	9·50	0·0633
1·25	0·0048	5·50	0·0360	9·75	0·0650
1·50	0·0068	5·75	0·0378	10·00	0·0660
1·75	0·0078	6·00	0·0395	10·25	0·0682
2·00	0·0105	6·25	0·0418	10·50	0·0698
2·25	0·0125	6·50	0·0430	10·75	0·0714
2·50	0·0143	6·75	0·0448	11·00	0·0730
2·75	0·0163	7·00	0·0465	11·25	0·0745
3·00	0·0180	7·25	0·0472	11·50	0·0760
3·25	0·0199	7·50	0·0500	11·75	0·0775
3·50	0·0217	7·75	0·0517	12·00	0·0785
3·75	0·0235	8·00	0·0533	12·25	0·0805
4·00	0·0253	8·25	0·0550	12·50	0·0820
4·25	0·0269	8·50	0·0566	12·75	0·0835

In the qualitative examination of nitric acid impurities, such as chlorine, sulphates and iron are detected in the usual manner. The presence of hyponitric acid is at once apparent from a more or less marked yellow coloration.

The quantitative examination is made chiefly to determine the value of the acid for manufacturing purposes, and the result is best given as percentage of pure nitric acid monohydrate it contains.

A small quantity of water is put in a flask with a glass stopper ground in, and holding 100 cubic centimetres. The flask and water are weighed, and about 10 cubic centimetres are taken with a pipette and titrated with deci-normal soda solution, using phenol-phtaleine, or methyl-orange, as an indicator, the latter being preferable. One cubic centimetre of deci-normal soda solution corresponds to 0.0063 gramme of nitric acid monohydrate. More exact results are obtained if 2 grammes are weighed in a flask as above, and the whole is titrated after diluting it with water. The number found indicates the total acidity calculated as nitric acid, but the percentage of hyponitric acid will have to be deducted. This is determined by the following method, which was first proposed by Feldhaus and closely examined by Lunge:—

A quantity, taken at random, of deci-normal permanganate solution is run into an Erlenmeyer's flask from a burette, and to this 2 cubic centimetres of nitric acid are added drop by drop from an accurate pipette and shaken. Care must be taken to keep the pipette immediately above the permanganate solution. The quantity of nitric acid used should be sufficient to discolour the solution of permanganate. It is then diluted with water, and more permanganate solution added from a burette until after shaking for a minute the distinct pink colour still remains. If this precaution is not taken, considerable heating will occur, and nitrous fumes which will impair the result be developed. One cubic centimetre of deci-normal permanganate solution corresponds to 0.0046 gramme of hyponitric acid. The weight of hyponitric acid so found is divided by the specific gravity of the nitric acid and multiplied by 100. This gives the volumetric weight of hyponitric acid, in per cents. of monohydrate.

If it be assumed that the nitric acid contains no other impurity than hyponitric acid, then the percentage of nitric acid monohydrate can be determined by means of Lunge and Rey's table. The specific gravity of the nitric acid must be determined by means of a hydrometer, reading to the fourth decimal, then the percentage of hyponitric acid found by the method given above, and deducted from the percentage of nitric acid corresponding to the specific gravity of the acid according to the table. In most cases this determination is sufficient.

In most countries it is customary to buy it by specific gravity or degrees Baumé or Twaddell. From the tables of Lunge and Marchlewski, it will be seen that this can only give rise to errors.

If, for instance, nitric acid of 1.500 specific gravity is bought, and it contains 1 per cent. of hyponitric acid, it will then only contain 92.60 per cent. of pure nitric acid monohydrate instead of 94.02—that is  $1\frac{1}{2}$  per cent. less than if pure. To describe any acid in degrees Baumé is still more unreliable, because an exact definition of this hydrometric scale does not exist. It is, however, becoming more and more the custom to designate commercial nitric acid in a rational manner, namely, by the percentage of pure nitric acid monohydrate it contains.

### 30. SULPHURIC ACID.

Although explosives factories using sulphuric acid on a large scale frequently have their own plant for manufacturing it, it is nevertheless beyond the scope of this book to give a description of its manufacture. It is also superfluous, because there exists an admirable standard work on the subject by Dr. George Lunge, in which those interested in the matter will find information on everything required.

For explosives, only the strongest and most highly concentrated sulphuric acid is as a rule used. It is employed in nitration, in which its *rôle* is the immediate absorption of any water chemically formed during the process, in order that the nitric acid may remain at its proper strength. It is evident that highly concentrated sulphuric acid is most effective for this purpose. Those nitrating processes, the manufacture of nitro-benzene or collodion cotton for instance, in which weaker nitric acid is used, are exceptions, since dilution can be effected by using sulphuric acid of lower concentration. As a rule, it may be taken that the sulphuric acid to be used for nitration should be used as free from iron as possible, and that it should not contain more than about one-tenth per cent. of arsenic, as both these substances reduce nitro-compounds.

Sulphuric acid is examined like nitric acid, by titrating with deci-normal soda solution, methyl-orange being used as an indicator. One cubic centimetre of deci-normal soda solution corresponds to 0.0098 gramme of sulphuric acid monohydrate.

It is purely a matter of calculation whether in some cases it is not more advantageous to use sulphuric acid of 97 per cent., or more, monohydrate, instead of 95 per cent. The answer will depend chiefly upon the price of acid. Under 94 per cent. it



is no longer suitable for some operations, especially for the manufacture of nitro-glycerin, since the yield becomes too small.

Sulphuric acid can be easily stored and carried in wrought-iron tanks, such as old boilers, and even acid of 1.600 specific gravity is not materially affected by such storage, provided the storage vessel be kept tightly closed.

Attempts have recently been made to strengthen the waste acid from the manufacture of gun-cotton, by mixing anhydrous sulphuric acid with it, and thereby making it again available. The heat evolved with such mixture is so considerable that without means of artificially cooling the waste acid it decomposes, and the nitric acid contained is driven off, with the development of large quantities of nitrous fumes. Moreover, the quantity of anhydrous acid required is considerable, and there is a constant excess of unsalable acid obtained, which makes the process expensive.

## CHAPTER II

### GENERAL PROPERTIES OF EXPLOSIVES

AN explosion takes place when by some mechanical or chemical agency a body is suddenly transformed into a gaseous state. The quantity of heat, the quantity of gases developed, and the time within which this takes place, determine the force of the explosion. An explosive is therefore a body which possesses the property of suddenly liberating large quantities of gas and heat, and by their action is capable of performing work.

Chemical science has already discovered a large number of explosive bodies, and it may be safely assumed that there are others still to be found. It is unnecessary to enumerate them, as they are to be found in almost every large work on chemistry. Explosives only acquire a real significance if they can be used for practical purposes, when it is not sufficient that the body should be merely capable of exploding. For instance, coal-gas, if mixed with air, is explosive, and use is made of this property in the well-known gas-engines, nevertheless it cannot be considered as an explosive in the general sense of the word. In order to be properly considered as an explosive for practical use, a body must fulfil the following conditions: First, it must not develop less than a certain minimum of energy. Secondly, its use should have no injurious action on health, nor be otherwise inconvenient. Thirdly, it must be of a nature suitable for the ordinary conditions of manufacture, storage, and use, and it must also have sufficient stability—that is, it must neither volatilize, nor alter mechanically or chemically when kept. Fourthly, its manufacture on a large scale must not be attended with difficulties, and its cost must be in proportion to the work it does. Considered from these points of view, a number of bodies possessing explosive properties are not applicable as practical explosives.

From a chemical point of view explosives cannot be classified in a definite manner, because neither their composition, nor

their formation, nor the quantity of gas developed, nor the heat liberated are favourable for such a classification. According to the manner in which a full development of their force can be initiated, Colonel Hess divided explosives into two groups. First, low explosives (directly exploding materials), and secondly, high explosives (indirectly exploding materials). The type of the first class is black powder, which can be made to exert its full force by a direct action—for instance, by ignition. The type of the second class is gun-cotton, the highest effect from which can only be obtained by use of an intermediate agent—a detonator, for instance.

The pressure of a given quantity of gases is, according to Gay-Lussac's law, proportionate to their temperature. The greater, therefore, the quantity of heat which is imparted to a certain quantity of gas, the higher will its pressure become. The heat developed on decomposition can therefore be taken as a measure of the theoretical strength of an explosive, which can generally be expressed by the formula  $E=425 Q$ , in which  $E$  is the maximum potential work in kilogramme-metres, and  $Q$  the number of calories developed by the decomposition.

In practice an important factor enters into this formula—the duration of explosion. According to the classical example given by the late Lieut.-Colonel Cundill, a certain quantity of wood can slowly burn away under a boiler, and would yet develop just as much heat and the same products of combustion as if burnt rapidly, but the heat would be rapidly dispersed, and its action on the boiler would be lost; the same thing takes place with explosives. If a certain quantity of an explosive is decomposed, a large part of its heat is lost by the cooling action of the walls surrounding it. The shorter the time, therefore, in which complete change into gas takes place, the more heat remains to increase the pressure of gas.

According to the investigations of Berthelot and Vieille, an undulatory movement takes place on explosion; it is a single wave which is characteristic, and carries forward the chemical alteration from point to point. Sir Frederick Abel was the first to point to the setting up of molecular vibrations by explosion. Abel found also that there is a certain synchronism between these vibrations which must exist for simultaneous explosion to take place; gun-cotton, for instance, only burns away when dynamite is exploded on the top of it, whilst in the reverse arrangement both compounds explode. Vieille has determined

by direct experiments that when an explosion takes place in a closed space, a true undulatory wave is set up, which, when it reaches the enclosing walls, is reflected back with the effect that at certain points in the exploding mass an addition of the direct and reflected waves occurs, and consequently a greater effect than would be possible without this reflection of the primary wave.

The heat of combustion, that is, the absolute quantity of heat that would be given off by unit weight of an explosive, on cooling it down at constant volume from the temperature of explosion to absolute zero ( $-273^{\circ}$  C.), has been determined experimentally several times. The researches of Berthelot, Roux and Sarrau, and Noble and Abel, on this subject are classical, and a description of some of the apparatus used by them will be found in the chapter dealing specially with the various apparatus used for the examination of explosives.

Roux and Sarrau obtained in their experiments the following values for complete explosion:—

	CALORIES.
Fine sporting powder ... ..	849
Cannon powder ... ..	795
Rifle powder B ... ..	773
Exportation powder... ..	736
Blasting powder ... ..	612
Nitrogen chloride ... ..	339
Nitro-glycerin (obtained by multiplying the result for dynamite of 75 per cent. by $\frac{1}{3}$ ) ... ..	1784
Gun-cotton ... ..	1123
Picric acid ... ..	852
Potassium picrate ... ..	840
Mixture of { Potassium picrate 55 } { Potassium nitrate 45 } ... ..	964
Mixture of { Potassium picrate 50 } { Potassium nitrate 50 } ... ..	1224
Mercury fulminate ... ..	752

Bunsen and Schischkoff found the heat developed by one kilogramme of black powder to be  $619\frac{1}{2}$  calories. Noble and Abel, after reviewing all preceding work, and refuting the objections of Berthelot, amongst others, to their method, found the following heat of combustion for the powders examined by them:—

	CALORIES.
Pebble powder, W. A. ... ..	721.4
R. L. G., W. A. ... ..	725.7
F. G., W. A. ... ..	738.3
Curtis and Harvey's No. 6 ... ..	764.4
Spanish cylinder powder... ..	767.3
Blasting powder ... ..	516.8

Berthelot (see the English translation of his work, 'Sur la force des matières explosives,' by Macnab and Hake) made the calculation of the heat of combustion the object of a special study based on theoretical grounds. His observations led him to the discovery of the following general principles:—

Firstly, "If a system of simple or compound bodies under constant volume and pressure undergoes a chemical or physical change without any exterior mechanical effect being produced, then the heat developed depends solely on the initial and final state of the system, and it is the same whatever the nature or the sequence of the intermediary changes may be."

Secondly, "If such a change is accomplished by a series of chemical and physical transformations following in succession, then the heat liberated is equal to the sum of the heats liberated in each single transformation."

Thirdly, "The heat liberated in a reaction is equal to the heat absorbed in the inverse reaction."

Fourthly, "The heat liberated on passing from one compound system to another one is equal to the difference of heat which is required for the formation of the initial and final composition."

Fifthly, "Each chemical transformation produced without the intervention of foreign energy tends towards the production of bodies liberating a maximum heat."

From the above it is evident that for the calculation of the heat developed on burning an explosive it is sufficient, according to the fourth principle above, to know the equation of the process of combustion, and the quantity of heat developed or absorbed by each component in the initial and final states, and the difference between the two will give the number of calories liberated by the combustion of the explosive in question.

The temperature of combustion, which is, of course, different from the heat of combustion, is that temperature which would be acquired by the products of combustion if the heat on combustion were exclusively used for heating them.

Prechtl, basing his calculations on the heat developed by combustion of charcoal and the specific heat of the various compounds, estimated the temperature produced by exploding black powder to be 8984° C. Bunsen and Schischkoff examined sporting powder in the open air, and under pressure. They use the quotient  $\frac{W}{S}$ , in which the numerator shows the quantity of heat developed on combustion of a certain quantity of powder, and

the denominator the sum of the specific heat of the products of combustion of powder compared with water. They obtained for W the real heat of combustion, 619.5 calories; and for S the specific heat of 0.207 for combustion in open air, and of 0.1857 in a confined space, whence they obtained the temperatures of combustion of 2993° and 3340° respectively. Sarrau obtained similar high results.

Noble and Abel, in their frequently-quoted 'Researches on Fired Gunpowder,' question the truth of these results. Although they had not sufficient data for the exact calculation of the real temperature of explosion, yet on theoretical grounds they came to the conclusion that for "Pebble" or "R. L. G." powder it would be about 2100°; for Spanish cylinder powder, 2200°; and for blasting powder about 1800°.

Lieut.-Colonel Chevalier de Vuich, in the 'Mittheilungen über Gegenstände des Artillerie- und Geniewesens,' shows that with the methods hitherto in use for the determination of the temperature of explosion, the fault has been that the specific heat has been assumed to be independent of the temperature. He introduced into the calculation a correction based on Wiedemann's experiments, which show that the specific heat of carbonic acid is increased by 0.000155 for each degree of temperature. The formula he thus obtained was

$$A = \frac{c_0 + \sqrt{c_0^2 + 2 Q_r a}}{a}$$

in which  $c_0$  is the absolute specific heat of the products of explosion;  $Q_r$  the quantity of heat given off by the explosion of 1 kilogramme, and,  $a$ , Wiedemann's co-efficient. By this formula Vuich calculated the following data:—

	BLACK POWDER.	POWDER FROM					NITRO-GLYCERIN.
		1 Molecule Trinitro cellulose, 2 Molecules Dinitro cellulose.	1 Molecule Trinitro cellulose, 1 Molecule Dinitro cellulose.	2 Molecules Trinitro cellulose, 1 Molecule Dinitro cellulose.	Pure Trinitro cellulose.	Ballistite 1 Part Nitro-glycerin, 1 Part Dinitro cellulose.	
Specific heat $C_0$	0.1855	0.2183	0.2146	0.2121	0.2064	0.2110	0.1971
Temperature of combustion	1874°	2110°	2234°	2329°	2516°	2697°	3005
Reduced quantity of heat $Q_r$	670	866	920	972	1066	1190	1480

The quantity of heat thus calculated can be taken as the measure of the energy developed by the explosive, since the pressure

it will set up depends on it alone and is a direct function of it. If the heat of combustion is multiplied by the mechanical equivalent of heat (425), then the maximum work which can be performed by 1 kilogramme of explosive is obtained, assuming that complete change into gas takes place adiabatically, that is to say, without either the addition or abstraction of heat. This product (heat of combustion by the mechanical equivalent of heat) is called the potential of an explosive.

In reality, only part of the work that is theoretically possible for an explosive to develop is obtainable as useful work. Sébert and Hugoniot found the ratio of the theoretical and the actual work of black powder to be as 305 is to 134, that is, only about 44 per cent. of the total force is available. Practical experiments have shown that the work that can be performed by 1 lb. of black powder is 290 foot-tons.

In former times they had peculiar ideas as to the force of black powder. Thus, for instance, Schreiber, in his 'Büchsenmeister Discours,' A.D. 1656, says about the force of black powder: "Wenn der brennende Schwefel unter den kalten Salliter kommt, so hebt der Salliter an zu spritzeln und speyen und zapfelt von wegen der widerwärtigen Hitze des Schwefels, so ihm ganz zuwider ist, so machen Hitze und Kälte solch einen starken Dampf, der sonst läufig ist." ("If the burning sulphur comes under the cold saltpetre, then the saltpetre begins to spurt and spit, and it splutters on account of the unpleasant heat of the sulphur, which is very disagreeable to it. Thus heat and cold make such a strong vapour which would otherwise disperse.")

In order to increase the propelling force of black powder, sal-ammoniac, camphor, arsenic, mercury, and verdigris have been recommended in former times.<sup>1</sup>

Later on, it was held that the small quantity of moisture which on combustion of the powder is transformed into steam,

<sup>1</sup> The following passage, taken from a manuscript of the year 1563, shows what curious ideas were formerly held, and is worth quoting here as a curiosity: "For saltpetre to make poisonous breath add, when molten, small serpents, toads, spiders, blindworms, and basilisks. If you have not the latter, you make them artificially in the following way: Put fresh eggs greased with linseed oil for a fortnight in sheep's dung, then worms will develop which eat each other. The last one feed on men's blood which is bled in the bathing-house, or with the back of a rat. On feeding it close your mouth with rue and sage. After a fortnight burn it to ashes on an open field in a well-luted glass. You can also imprison together a pair of two-year old cocks with fiery red eyes until they are copulated, and let the eggs be bred by a large toad."



increased the pressure. This is certainly not correct, because the combustion is retarded on account of the moisture of the powder. The temperature of combustion is therefore lowered, and more heat is required for the formation of steam than the steam contributes to the tension. Robins, as early as 1743, stated in his 'Nouveaux principes d'Artillerie,' that moisture had a markedly bad effect on the force of black powder, and this has been confirmed by more recent experiments. In the same way those statements that the atmospheric air enclosed in the interstices and pores of the black powder increases the propelling power on account of the air expanding by the heat of combustion and producing a better combustion for the black powder, are incorrect. A Prussian manuscript of 1741 states, to some extent correctly, that saltpetre develops air on heating; this is the effective part of the powder, not the air between the grains. Nevertheless, in 1842, Coxthupe proposed to enclose air between the charge and the projectile, by which he imagined he would require some 20 per cent. less black powder, but his process did not find favour with artillerists.

If the expansion of gases, which increases with the temperature set up by the explosion, is prevented by the resistance of some body, the gases of necessity exert a pressure on that body, the amount of which depends mainly upon the temperature of the gases. This pressure must therefore be set up when black powder is burnt in a closed space. The degree of pressure has been determined at various times. Rumford, in 1797, from calculations which he had made, gave it as 54,000 atmospheres. Piobert gave it as between 5000 and 10,000 atmospheres. Bunsen estimated that with sporting powder a pressure of 4373·6 atmospheres, corresponding to a theoretical work of 21·71 foot-tons, was produced. Noble and Abel examined the relation between gas-pressure and the density of the products of explosion. They obtained the following results with "Pebble" powder and "R. L. G." powder.

DENSITY OF PRODUCTS OF EXPLOSION.	PRESSURE PER SQUARE CENTIMETRES.	DENSITY OF PRODUCTS OF EXPLOSION.	PRESSURE PER SQUARE CENTIMETRES.
0·1	231·5	0·6	2266·3
0·2	513·4	0·7	3006·5
0·3	839·4	0·8	3942·0
0·4	1220·5	0·9	5112·1
0·5	1683·6	1·0	6567·3

Further particulars on the calculation of the force and the gas-pressures of explosives may be found in the papers by Sir Frederick Abel and Sir Andrew Noble. Their methods of experimenting are referred to further on.

## CHAPTER III

### BLACK POWDER

#### 1. COMPOSITION

BLACK powder from its earliest times has always consisted of saltpetre, sulphur, and charcoal, mixed in various proportions according to whether a military, a sporting, or a blasting powder was required. The various kinds of powder have to serve various objects. With military powder great propulsive force is required; with sporting powder, quick ignition and combustion; and with blasting powder as large as possible a quantity of gases at a high temperature.

The ease with which black powder is ignited is not materially influenced by the proportions of the ingredients. An excess of charcoal quickens combustion; an excess of saltpetre slackens it. The propulsive force depends chiefly on the rate of combustion and the volume of gases produced, which of course vary with the proportions of the mixture.

In the course of centuries the proportions have undergone a constant change, as will be seen from the examination of a series of recipes for military powder. Before the right proportions were arrived at, many experiments extending over a long period had to be made. With all the experiments made to find the proper mixtures, only experience could show the way. In former times theoretical investigations were rarely made; but also in modern times it is the propulsive force of powder that has been chiefly considered, and more regard has been paid to the method of manufacture than to theoretical considerations as to combustion.

At the end of the last century Berthollet endeavoured to experimentally determine proportions that would give the best powder mixture, and arrived at the following:—80 parts of saltpetre, 5 parts of sulphur, and 15 parts of charcoal.

More recently Berthelot has calculated the proportions the three ingredients should have in the mixture in order to get the theoretical maximum of heat and the minimum of gaseous

products. These he found to be 84 parts of saltpetre, 8 parts of sulphur, and 8 parts of charcoal. Assuming that the charcoal consists of pure carbon, then the stoichiometric proportion for the formula,  $2\text{KNO}_3 + \text{S} + 3\text{C}$ , would be 74.84 parts of saltpetre, 11.84 parts of sulphur, and 13.32 parts of charcoal. Of course theoretical considerations cannot be alone of importance, since black powder is not a chemical product but a mechanical mixture, on the intimate and careful incorporation of which its complete combustion depends. It has, however, been proved by experience that a higher percentage of sulphur increases the keeping qualities of black powder, and on the other hand that the charcoal used is never pure carbon. The percentage of moisture changes, and the powder mixture also undergoes some change of composition during the various operations.

The results of experiments in the following table made with Prussian black powder show this very clearly:—

STATE OF THE POWDER.	PERCENTAGE OF		
	Saltpetre.	Sulphur.	Charcoal.
Normal proportions ...	74	10	16
Incorporated charge ...	74.30	10.13	15.84
Powder-cake ...	73.60	10.25	16.15
Granulated cake ...	73.66	10.38	15.96
Air-dried powder ...	73.94	10.20	15.86
Sifted powder ...	74.43	9.73	15.84
Dusted powder ...	74.49	9.72	15.79

The earliest mixture used in Germany is said to have consisted of equal parts of saltpetre, sulphur, and charcoal. In 1546 the following proportions were given:—

	LARGE GUNS.	MEDIUM GUNS.	MUSKETS.
Saltpetre ...	50	66.7	83.4
Sulphur ...	33.3	20	8.3
Charcoal ...	16.7	13.3	8.3

Fronsperger, in his 'Kriegsbuch' of 1555, gives the proportions as  $66\frac{2}{3}$  parts of saltpetre,  $22\frac{2}{3}$  parts of sulphur, and  $11\frac{1}{3}$  parts of charcoal.

In 1649 the following were recommended:—

	FOR LARGE GUNS.	FOR MUSKETS.	FOR PISTOLS.
Saltpetre ...	66.8 ; 70.0	72.5 ; 75.5	78.7 ; 85.6
Sulphur ...	16.6 ; 14.0	13.0 ; 11.2	9.4 ; 8.5
Charcoal ...	16.6 ; 16.0	14.5 ; 13.3	11.9

In 1774 the mixtures used in Prussia were:—

	LARGE GRAINED POWDER.	FINE GRAINED POWDER.
Saltpetre ...	74·4	80
Sulphur ...	12·3	10
Charcoal ...	13·3	10

At the beginning of this century the following proportions obtained in Prussia:—75 parts of saltpetre, 10 parts of sulphur, and 15 parts of charcoal; but they were soon replaced by the following:—75 parts of saltpetre, 11·5 parts of sulphur, and 13·5 parts of charcoal.

Boillot, in France, in his 'Modelles d'artifices de feu,' and also de Bry in 1619, recommended as the best mixture:—75 parts of saltpetre, 12·5 parts of sulphur, and 12·5 parts of charcoal.

In 1686, 76 parts of saltpetre, 12 parts of sulphur, and 12 parts of charcoal were used in France; but in 1696 the original proportions were again employed. In consequence of experiments made in 1794, the following proportions were adopted:—76 parts of saltpetre, 9 parts of sulphur, and 15 parts of charcoal.

In 1800 the Swiss composition of 76 parts of saltpetre, 10 parts of sulphur, and 14 parts of charcoal was adopted; but in 1808 the old composition was again resorted to, and this is still used now-a-days.

In Sweden the composition altered as follows:—

	1726.	1770.	1827.
Saltpetre ...	73	75	75
Sulphur ...	10	16	15
Charcoal ...	17	9	10

In Nye's 'Art of Gunnery' (London, 1670), it is stated that the following proportions were in use at different times:—

	SALTPETRE.	SULPHUR.	CHARCOAL.
About 1380 ... ..	1	1	1
„ 1410 ... ..	3	2	2
„ 1480 ... ..	8	3	3
„ 1520 (best powder) ...	4	1	1
„ 1670 (pistol powder)	6	1	1
„ 1670 (musket powder)	5	1	1
„ 1670 (cannon powder)	4	1	1

The proportions used at the present time by the following Governments are:—

(a) *Rifle powder.*

	AUSTRIA- HUNGARY.	BELGIUM.	CHINA.	FRANCE.	GERMANY.	GT. BRITAIN.
Saltpetre ...	75	75·5	75	75	74	75
Sulphur ...	10	12·0	10	10	10	10
Charcoal ...	15	12·5	15	15	16	15

	HOLLAND.	ITALY.	PERSIA.	PORTUGAL.	RUSSIA.	SPAIN.
Saltpetre ...	70	75	75	75·7	75	75
Sulphur ...	14	10	12·5	10·7	10	12·5
Charcoal ...	16	15	12·5	13·6	15	12·5

	SWEDEN.	SWITZERLAND.	TURKEY.	UNITED STATES.
Saltpetre ...	75	75	75	75
Sulphur ...	10	11	10	10
Charcoal ...	15	14	15	15

(b) *Cannon powder.*

	AUSTRIA- HUNGARY.	FRANCE.	GERMANY.	GT. BRITAIN.	SWITZERLAND.
Saltpetre ...	74	75	74	75	75
Sulphur ...	10	10	10	10	10
Charcoal ...	16	15	16	15	15

(c) For sporting powder, where quick combustion is required, red charcoal is usually employed instead of black. There are hardly any records to be found as to the composition of sporting powder at various times. The present composition is:—

	AUSTRIA- HUNGARY.	FRANCE.	GERMANY.	GT. BRITAIN.	SWITZERLAND.
Saltpetre ...	75·95	78	78	75	78
Sulphur ...	9·43	10	10	10	9
Charcoal ...	14·62	12	12	15	13

(d) The chief requirements of blasting powder are that it should be cheap and develop a large quantity of gas. Attempts to satisfy these requirements by reducing the percentage of saltpetre and increasing that of charcoal, or sulphur, or both, were made, but on account of the smaller percentage of saltpetre the combustion became slower, and consequently the gases tended to escape through crevices of the rock, while more carbonic oxide was formed than was desirable in the atmosphere in the mines. Private powder factories in Germany have therefore resorted to considerably increased percentages of saltpetre, and as much as 78 per cent. has been used in powder, which is no doubt excessive.

The present composition of blasting powder in various countries is as follows:—

	AUSTRIA- HUNGARY.	FRANCE.	GERMANY.	GT. BRITAIN.	ITALY.	RUSSIA.
Saltpetre ...	60·19	72	70	75	70	66·6
Sulphur ...	18·45	13	14	10	18	16·7
Charcoal ...	21·36	15	16	15	12	16·7

In a certain sense the so-called brown or cocoa powder can be classified with black powder. The brown powder contains rye-straw charcoal instead of ordinary wood charcoal. Its composition is 78 parts of saltpetre, 20 parts of charcoal, and 3 parts of sulphur.

## 2. MANUFACTURE.

### (a) CAKING THE POWDER.

In making black powder the greatest importance must be attached to pulverizing the ingredients as finely as possible, to mixing together the powdered substance very intimately, and to giving the powder a high density. The effect of the black powder depends chiefly on these, because its decomposition takes place so much quicker the more intimately mixed and arranged side by side the small particles of saltpetre and charcoal are. Formerly, the pulverizing, mixing, and caking were done in one operation; in modern times each operation is done separately in all factories.

#### (a) *Pulverizing, Mixing, and Caking in One Operation.*

In the earliest times the three ingredients of gunpowder were pounded by hand in a wooden or stone mortar by means of a wooden pestle, which was lifted either directly by hand or by a pulley. This primitive method of manufacture, which required considerable working personnel, was soon improved by the introduction of stamp-mills. In Fig. 79 a stamp-mill used in 1686 is illustrated; it is taken from the 'Teatrum Machinarum Novum,' by George Andreas Böckler, of Nuremberg.

In the stamp-mills used at present the most important parts consist, as will be seen from Fig. 80, of a heavy block of oak or beech-wood (b), about 2 feet thick, in which a number of stamp-holes (a) are carved out. The distance of the stamp-holes from centre to centre is about 2 feet 4 inches, their depth about 20

inches, and their diameter about 16 inches. Formerly, the stamp-holes were cylindrical, but they are now made of spherical form, with a funnel-shaped opening at the top. A piece of hard wood set on edge (c) is inserted at the bottom of each stamp-hole.

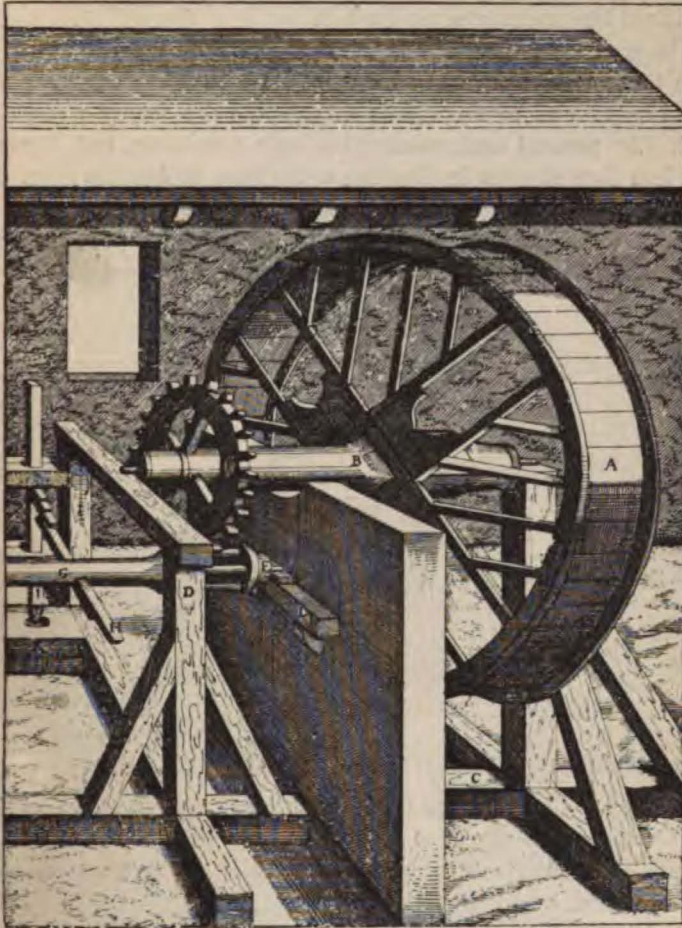

FIG. 79.

The block itself is tied by means of straps and bolts, and rests on a foundation which, as a rule, is a wooden grating, so that the bottom is properly supported to withstand the frequent blows of the stamp-head. The stamp stems (d) are rectangular in section, and about 7 feet to 10 feet long and 4 inches thick.



They are made from beech- or maple-wood, whilst the lower pea-shaped head (e) is made of bronze, and fixed on to the stem by a cotter. W. Güttler, of Reichenstein, provides his stamp mortar with a groove on one side in order to avoid inflammations through the heat generated by the air being suddenly compressed in this manner of the pneumatic tinder-box.

The composition of the bronze used for the head varies from 80 to 82 per cent. of copper and from 20 to 18 per cent. of tin. In the upper end of the stems lifting-pins are firmly wedged in a slot. At present each mortar has only one stamp, but formerly each had four stamps in Sweden and three in Austria (Fig. 81). Metal mortars also were formerly used instead of wooden ones.

The driving is done by means of a cam-shaft (A B, Fig. 82) on the circumference of which cams (c) are arranged in a spiral

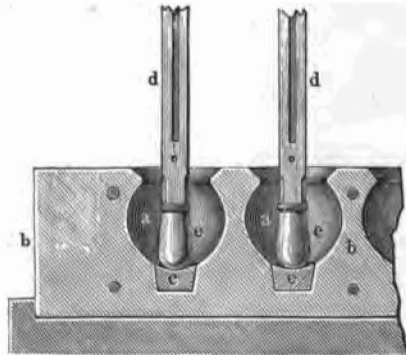

FIG. 80.

As the shaft rotates they engage with the pins on the stamp stems, and lift the stamp as long as the cam engages with the pin; at a certain point the cam leaves the pin and the stamp falls. The cam-shaft is driven through the wheels (L L) by a water-wheel or horse-whim.

The drop of the stamps is, as a rule, about 17 inches, and their weight between 44 and 66 lbs., according to the size of the mortar. In France in 1791 it was 72 lbs.; at present it is 88 lbs., with a fall of 16 inches.

In Denmark the weight is between 62 and 66 lbs., in Austria 37 lbs., and in some works 74½ lbs. (Neusohl stamps). Each stamp-mill, generally, has two sets of stamps, which are driven by a cam-wheel in the centre. Each set of stamps has, as a

rule, from 7 to 10 mortars, and in France from 8 to 12. The three ingredients of the black powder are simultaneously introduced in their proper proportions into the mortars—as a rule, about  $17\frac{1}{2}$  lbs. in each, or 22 lbs. in France.

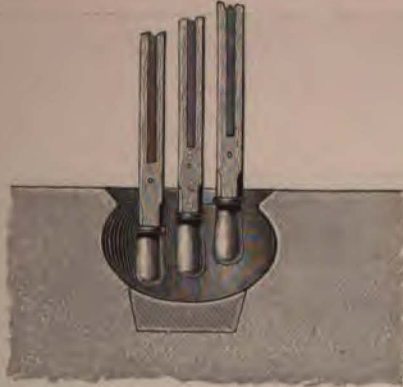

FIG. 81.

Originally the composition was then moistened with water, later on with vinegar also, and in the middle of the sixteenth

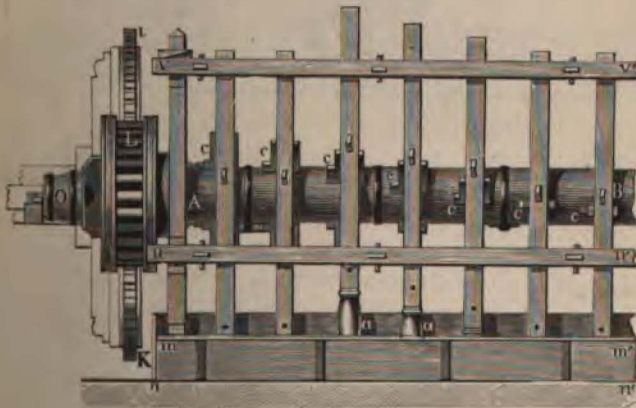

FIG. 82.

century it was considered excellent to moisten the charge with "man's urine who drinks wine."

The time of stamping at the end of the sixteenth century was 6 hours; at the beginning of the seventeenth century 10

hours for cannon powder, and 12 hours for musket powder; wh  
 about the year 1700 the time of stamping was 24 hours at  
 rate of 3500 blows per hour. In Great Britain stamp-mills a  
 prohibited on account of their danger, in Switzerland the wo

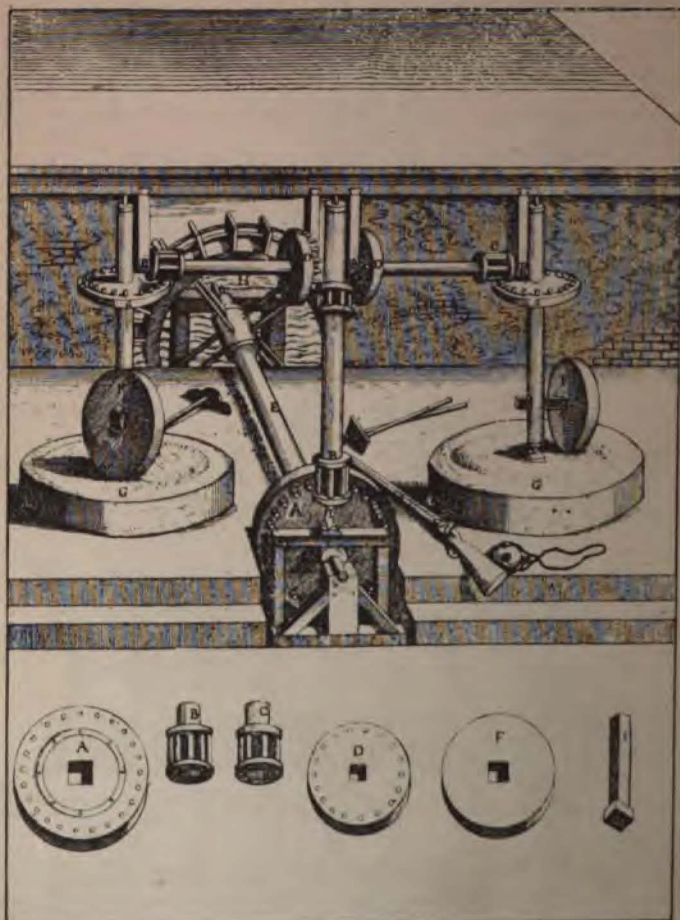

FIG. 83.

was done for some time by an apparatus similar in action to the  
 tilt-hammers used in iron-works. The incorporating of black  
 powder by means of incorporating-mills, which was formerly called  
 the mill-stone method, was known as early as the year 1540.  
 Biringuccio mentions that the incorporating-mills, which were

imitations of olive-mills, were not much in use on account of their danger; nevertheless, they are now largely used in Germany, Great Britain, and Italy.

In Fig. 83 an incorporating-mill, taken from Böckler's 'Teatrum Machinarum Novum,' is illustrated. Miethen reports that the first incorporating-mill in Sweden was introduced by Cnutberg in 1684. In France it was introduced in 1754 by Pater Ferry at Essonne.

The primitive incorporating-mills of former times were soon replaced by more rational ones, which will be more fully described later on. Formerly the runners were made of marble, and the bed of copper or wood. In the Royal Gunpowder Factory of Dresden they had lens-shaped, and in Russia ball-shaped runners. The latter form was proposed by Bottée and Riffault, partly to avoid the dangerous friction resulting from the tendency of the runners to run in the direction of the tangent, and partly to produce equal pressure on the whole extent of the bearing surface. Although danger is in this way diminished, yet in general, cylindrical runners are preferred, as it is just this friction they give that produces the better pulverizing and more intimate mixing. In 1756 at Essonne they even had wooden runners. Scrapers were first fixed on to the shaft by Munk in 1816.

(β) *Pulverizing each Component Separately.*

In pulverizing, mixing, and caking in one operation many explosions happened, especially at the beginning of the stamping or rolling, on account of the ignition of the charcoal. Moreover, the sulphur and the charcoal were not properly pulverized, in consequence of which the inflammability of the black powder suffered. This process has therefore been abandoned, and pulverizing separately before mixing and caking has been adopted.

In 1763 Desparcieux proposed to pulverize the single materials in stamps, but this proposal was not practically adopted in France until 1794, at which time, according to Chaptal, about one-sixth of the total stamps at work blew up annually. It cannot be said whether pulverizing in stamps had been used before. Now-a-days it is almost out of use, since much more effective machines for this purpose exist.

Cossigny, in 1787, introduced at Isle de France the practice of pulverizing the components in incorporating-mills; and Carny suggested, in 1791, pulverizing in drums, which was later on

improved upon by Chaptal. This process was introduced at that time in France because during the Revolution the existing stamps and roller-mills could not supply enough powder to meet the extraordinary demands made on them. In 1795, however, this process was for the greater part abolished, and only in 1822 did it again come into use.

In French and German Government factories all pulverizing is done in drums. In Russia and Switzerland only some of the components are pulverized in drums, whereas in Great Britain,

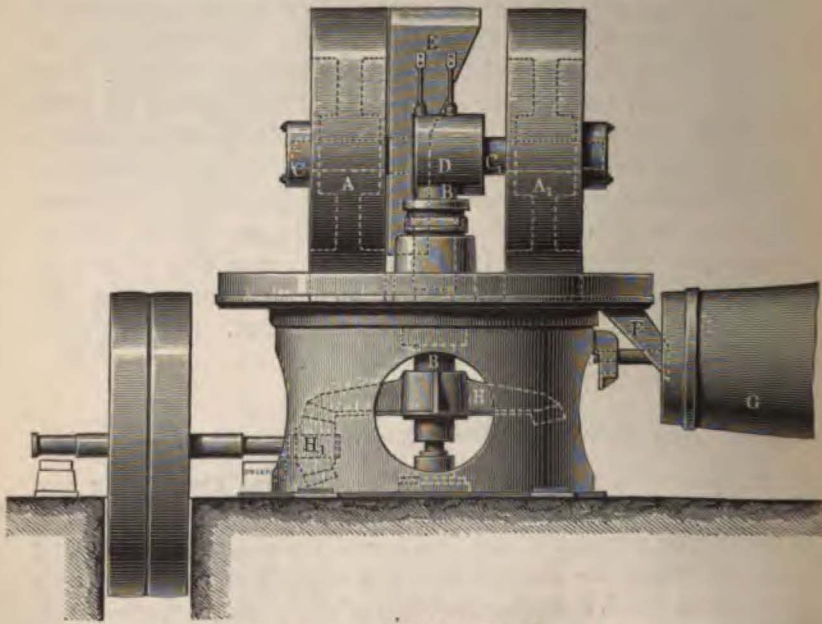

FIG. 84.—One-20th full size.

both in military and private factories, and in most of the German private factories, incorporating-mills are chiefly used for this purpose.

Fig. 84 shows an illustration of a modern incorporating-mill well adapted for pulverizing prime materials; it is made by FR. Krupp, Grusonwerk, at Buckau-Magdeburg. The two runners (A, A<sub>1</sub>) stand at unequal distance from the central vertical shaft (B), and the horizontal shafts (C, C<sub>1</sub>) are so placed that each can rise independently of the other in the horizontal cross-head (D). The materials are introduced through the shoot (E), and scrapers rotating with the main shaft rake up the material on



the bed. The opening with a shoot (F) on the side of the bed serves for emptying the pulverized materials into a sifting cylinder (G). The incorporating-mill is driven from below by means of the cog-wheels (H, H<sub>1</sub>).

Gruson's "Excelsior Mill" (Fig. 85) has recently come into use for pulverizing saltpetre. It consists of two vertical discs, one of which is carried on the casing, whilst the other is fixed

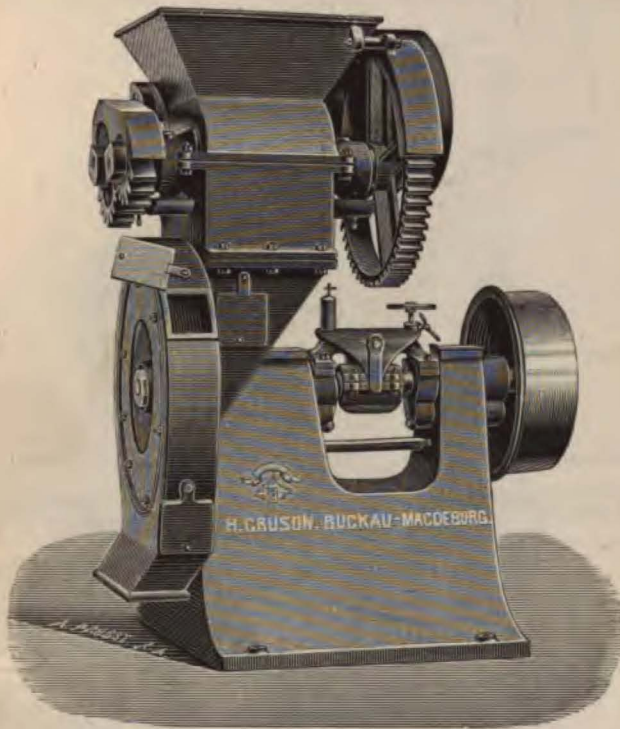

FIG. 85.

on a revolving-shaft. The discs have teeth arranged in a peculiar manner in circles at constantly-decreasing distances towards the middle. The material is fed in by a shoot on the casing between the two discs, and when pulverized is discharged into boxes, tubs, etc., through a shoot at the bottom of the casing. The distance between the two discs is adjustable by means of a screw. The "Excelsior" mills may also be used with advantage for the pulverizing of sulphur, but in this case they have a rough breaking

arrangement fixed on the inlet shoot, consisting, as is shown in Fig. 85, of two rolls and a shoot, and driven by a special pulley. The drums used at Spandau for pulverizing saltpetre are made of sheet-iron about a quarter of an inch thick; they are about 3

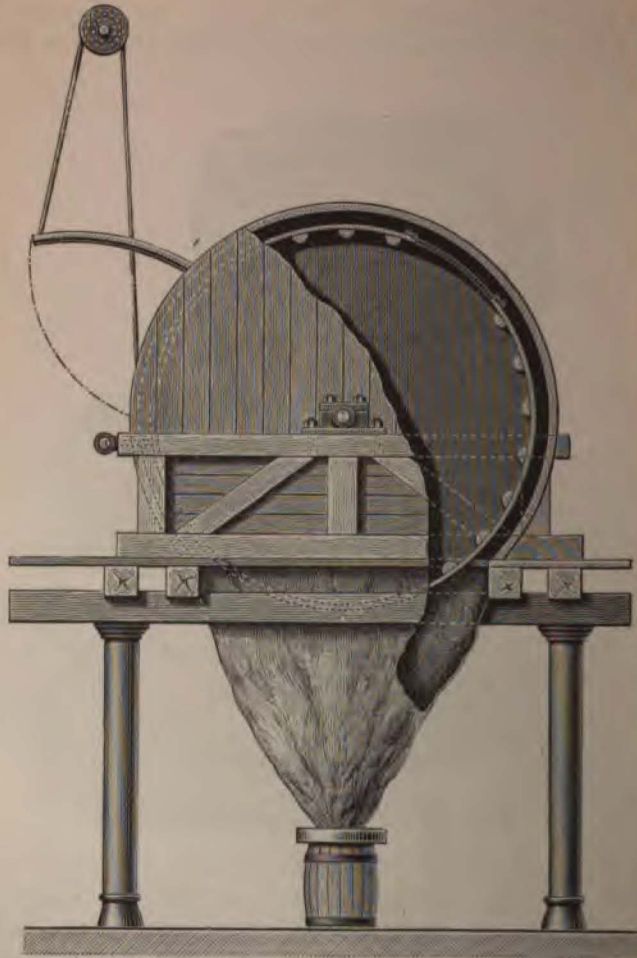

FIG. 86.—One-30th full size.

8 inches long and 3 feet 4 inches in diameter. On the interior there are six ribs of white beech-wood, and on the circumference of the drum two movable doors, one made of sheet-iron which closes the drum during pulverization, and the other performs



which replaces the first one when the pulverized mass is to be discharged.

At Spandau equal quantities of sulphur and saltpetre are, as a rule, pulverized together, because otherwise the sulphur cakes.

In Germany, France, Switzerland, and other countries the charcoal is pulverized in drums similar to those used for the sulphur. In Great Britain and in many private German factories bell-mills are used, consisting of a funnel-shaped case and an

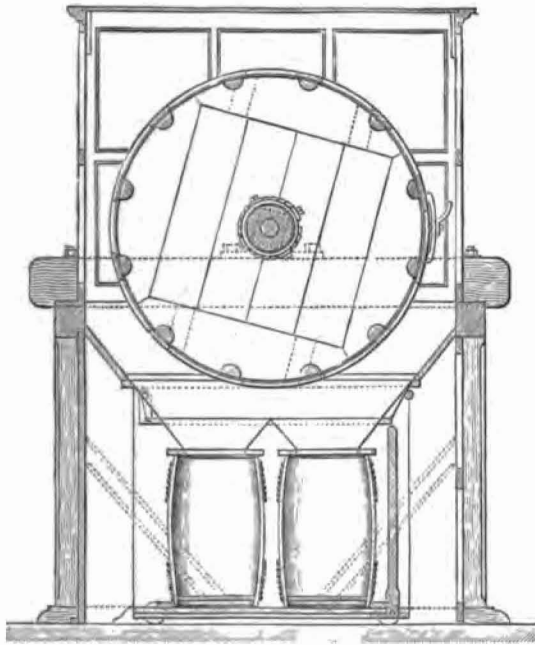

FIG. 87.—One-32nd full size.

inverse funnel-shaped breaking-cone running in the casing. Both the casing and the breaking-cone have screw-shaped projections on their surface. The breaking-cone is fixed on to a vertical shaft actuated by a pulley. The charcoal which falls into the funnel-shaped casing is broken by the revolution of the breaking-cone in the small space between the two, and falls out below.

Fig. 86 shows a form of drum for pulverizing charcoal used in Germany, and Fig. 87 a French one, the construction of which

can be readily understood from the drawing. Both have wooden bars at their circumference, which give the balls used for pulverizing a bumping motion, as the drum rotates. The German drum has a perforated plate instead of the door, by means of which the dust produced is continually sifted off. In many cases the drums are not made of wood, but consist of a wooden framework on to which a casing of sole-leather forming the drum is fixed by means of brass screws. This arrangement has the advantage that any defect of the drum can at once be recognized from the outside and repairs can easily be made. On the other hand, it has the disadvantage that the drum being leather durable wears out more quickly. In France, Great Britain, Switzerland, and certain other countries the saltpetre comes from the refiners in such a fine state that further pulverizing unnecessary. At Spandau it undergoes a preliminary grinding in a drum.

The charge of 220 lbs. of saltpetre and 220 lbs. of brass balls  $\frac{1}{2}$  inch diameter, is put into the drum, which makes twenty revolutions per minute. The time of pulverizing is three hours for rifle powder, and 15 minutes for cannon powder. In France the sulphur drums are charged with 66 lbs. of sulphur and 110 lbs. of brass balls between  $\frac{2}{3}$  and  $\frac{1}{2}$  inch diameter. With between 20 and 12 revolutions per minute the time of pulverization one hour.

At Spandau 110 lbs. of sulphur are pulverized at a time with 220 lbs. of  $\frac{1}{2}$  inch bronze balls for three hours at 8 to 10 revolutions per minute.

For mixing cannon powder 110 lbs. of sulphur and 110 lbs. saltpetre are introduced into the drum, together with 220 lbs.  $\frac{1}{2}$  inch brass balls, and treated for two hours, the drum making 10 revolutions per minute. At Spandau charcoal is pulverized 176 lbs. charges with 253 lbs. of  $\frac{1}{2}$  inch bronze balls in the drum. The latter is closed with a wooden cover, and makes 10 revolutions per minute. After 900 revolutions the drum is stopped, and a brass sieve inserted in the place of the wooden cover, and the drum again revolved until all the pulverized charcoal has fallen into the box below.

To prevent the powdered charcoal from clogging in the canvas discharge-funnel, which narrows at the lower end, this is occasionally squeezed by the workman. From the box the charcoal is put into barrels, each of which hold about  $35\frac{1}{4}$  lbs. In this process about 3 ounces are worn off the bronze balls for each 100 lbs. of charcoal.

powdered. For this reason the balls are sifted through a standard sieve, then weighed, and the loss in weight made up by new balls.

The charcoal drums in France have two compartments, each of which is charged with 33 lbs. of charcoal and 6.6 lbs. of balls  $\frac{9}{16}$  inch diameter, and worked for an hour at between 20 and 22 revolutions per minute. The gravimetric density of the charcoal continually increases during the pulverization of the charcoal, as can be seen from the following table, which is from French sources :—

TIME FOR PULVERIZATION.	GRAVIMETRIC DENSITY.
2 hours.	0.220
4 "	0.243
6 "	0.280
8 "	0.282
10 "	0.294
12 "	0.296

On pulverizing sulphur the mass not only clogs, but frequently ignites. An explanation of this has been sought in all possible directions. Hermann Güttler has proved that it is solely due to electrical phenomena. He therefore electrically connects the sulphur drums to earth, and since doing this he has had no further fires.

#### (γ) *Preliminary Mixing.*

In Great Britain and Germany, where black powder is mixed in incorporating-mills, the ingredients undergo a preliminary intimate mixing in a special mixing-drum. In Great Britain the drum is made of copper or brass, and is about 2 feet 9 inches diameter and 1 foot 6 inches in width. The drum is traversed by a shaft, on which eight rows of bronze fork-shaped arms are fixed. The drum revolves in an opposite direction to the shaft, and makes 40 revolutions per minute to 80 of the shaft. After mixing for five minutes the drum is discharged, and the contents sifted by hand in order to retain any pieces of wood, nails, or any other foreign substances which may have fallen into the mixture. Such a mixture is called a green charge.

#### (δ) *Mixing and Caking in Stamp-mills.*

In the older German factories, sulphur and saltpetre, which have been previously pulverized and sifted, and which are kept

in special buckets, are added to the charcoal after it has been pulverized in the stamp-mills. After being well mixed by hand, sufficient water is added to bring the moisture in the mixture up to between 16 and 20 per cent., including that previously added to the charcoal. The surface of the mortar is then brushed clean, the dust-covers (perforated covers through which the stamps fall) are put on, and the stamps are let down on to the charge. Water is then slowly run on to the water-wheel, so that the stamps at first work slowly, but gradually increase to the ordinary number of blows per minute. As soon as the stamps are working at full speed, all openings are closed in order to prevent draughts which might cause any parts not yet sufficiently mixed to be thrown out as dust. For about a quarter of an hour the striking of the stamps on the bottom through the charge is carefully guarded against. This event can easily occur when the mass is too loose, causing it to spurt about and adhere to the walls of the mortar, with the result that a part of the charge is not subjected to the action of the stamp. On the other hand, the charge must not be too dry, since it would then be too dusty, and the stamps would only beat upon the charge at the bottom of the mortar. If the charge is of proper consistency it forms a dough, which is driven up the walls of the mortar by the blows of the stamps, then gradually detaches on account of the inclination of the stamp-holes, and falls back again below the stamps. However perfect the stamp-heads and the form of the stamp-holes may be, it may nevertheless occur that a hard-caked mass adheres to the bottom and to the stamp-heads, which through continued stamping becomes so hard that ignition may take place. To avoid this the charges are from time to time transferred. To effect this the stamps are stopped and lifted, and the charge of the first stamp-hole is put into a receptacle. Any lumps which have been formed are carefully broken up by hand, and all caked portions in and round the mortar are removed by means of a special scoop-shaped scraper made of strong sheet-brass. The charge of the second mortar is treated in the same way and put into the first one, and so on, and finally the charge of the first one is transferred from its receptacle into the last mortar. In order to hasten the work two workmen do this changing simultaneously in ten stamp-holes, one starting at the first and the other at the sixth hole.

The first changing of the charges takes place after 2000 blows, and is repeated after each succeeding 4000 blows. If the charge is seen to be too dry when being changed, it is moistened.

This must be left to the judgment of the workman in charge of the process, as exact rules cannot be given, since the dampness depends on the temperature. The moistening is always done with small quantities of water only, after which the charge is mixed by hand. One workman usually moistens and mixes the charge in two mortars at a time. As some of the charge may adhere to the hands of the men doing the changing and sweeping, they are made to wash their hands in special buckets, and this washing-water is then used for moistening or "watering" the charge, in order that none of it may be lost. The crust which from time to time cakes on to the brass heads of the stamps must not be removed by knocking, since this would loosen the stamp-heads; but after the stamping operation is finished, the stamps are allowed to stand overnight in special vessels filled with water, which are placed above the covered mortars, and on the following morning they are wiped clean and dry. The number of blows is, as a rule, 55 to 60 per minute, but the time of stamping varies in different mills from 14 to 36 hours.

In modern works the work is done in the same way, except that the ingredients are pulverized in drums instead of under stamps. The time of working in this case is 36 hours, and the quantity of water used for watering is only from 4 to 9 per cent.

In Austria, with the so-called German stamps, they have three stamps working in one mortar which takes a charge of 55 lbs. With the Neusohl stamps the charge is  $18\frac{1}{2}$  lbs., and in smaller ones of the same kind only  $14\frac{1}{2}$  lbs. in each mortar. The time of stamping with Neusohl stamps is from 31 to 55 hours for "target" and sporting powder, 24 to 44 hours for military powder, and 16 to 30 hours for blasting powder. With the German stamps the time is 60, 48, and 36 hours respectively.

In France each mortar is charged with 22 lbs. of the mixed ingredients and 22 lbs. of water. At the time of the Revolution the time of stamping was 14 hours, later on 12 hours, and in 1802 as short as three hours only. In 1807, 14 hours were again given, since the powder manufactured in the previous years was of no use. In Denmark each mortar receives a charge of 11 lbs., which, according to the temperature, is moistened with from 10 to 12 per cent. of water. The charge is first stirred and then stamped for an hour at 18 blows per minute. It is then changed and again stamped for 35 hours, at 24 to 36 blows per minute. During this time it is again changed two or three times, and if it becomes very dry it is watered during the stamping.

Mixing and caking in incorporating-mills is now-a-days no longer done, since caking by hydraulic presses gives much better results.

(*ε*) *Mixing of the Pulverized Ingredients.*

This is now done in only two ways—either in drums or in incorporating-mills. In Germany, France, Sweden, Austria, etc.,

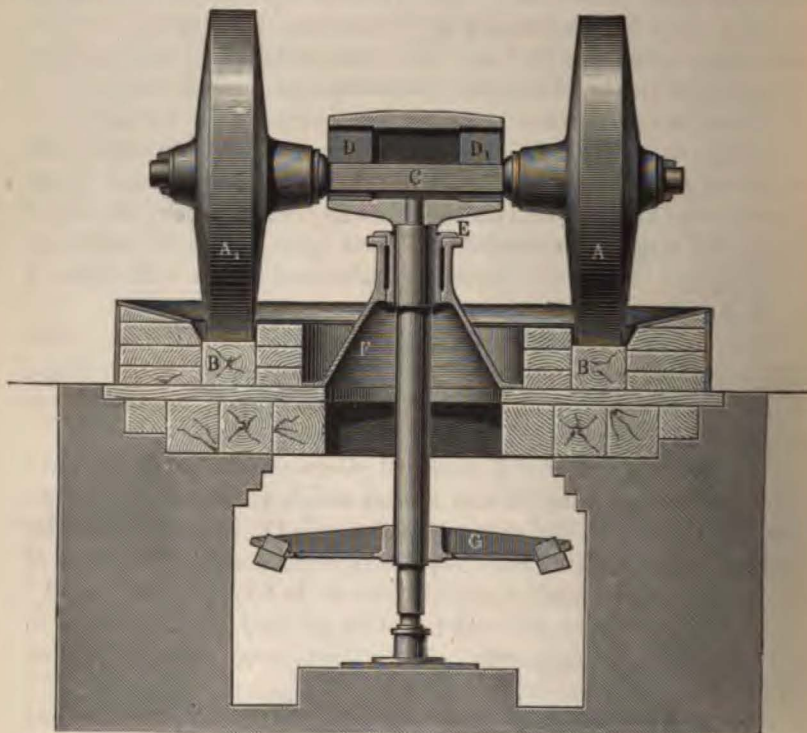

FIG. 88.—One-25th full size.

mixing-drums are preferred; in Great Britain, Switzerland, and private German factories incorporating-mills are chiefly used.

At Spandau the mixing-drums are made of sole leather, fixed on to a wooden framework with 24 strips, all metal fittings being made of bronze. In Sweden the drums are about 3 feet 4 inches diameter, and 4 feet 8 inches to 5 feet 2 inches long; in Austria, 2 feet 8 inches diameter and 3 feet 4 inches long. In France they are similar to those used for the binary mixture. In Italy they are made in two compartments. The charge at Spandau for rifle powder is 220 lbs.,

with 220 lbs. of lignum vitæ balls of various sizes, from  $1\frac{1}{4}$  inches to 2 inches in diameter. The time for mixing is 2 hours at 8 to 10 revolutions. For cannon powder 330 lbs. of bronze balls of  $\frac{1}{4}$  inch diameter are introduced with 220 lbs. of powder, and mixed for the same time. At Hamm the drums have a circumferential velocity of from 1 foot 8 inches to 2 feet per second. In Sweden, in drums

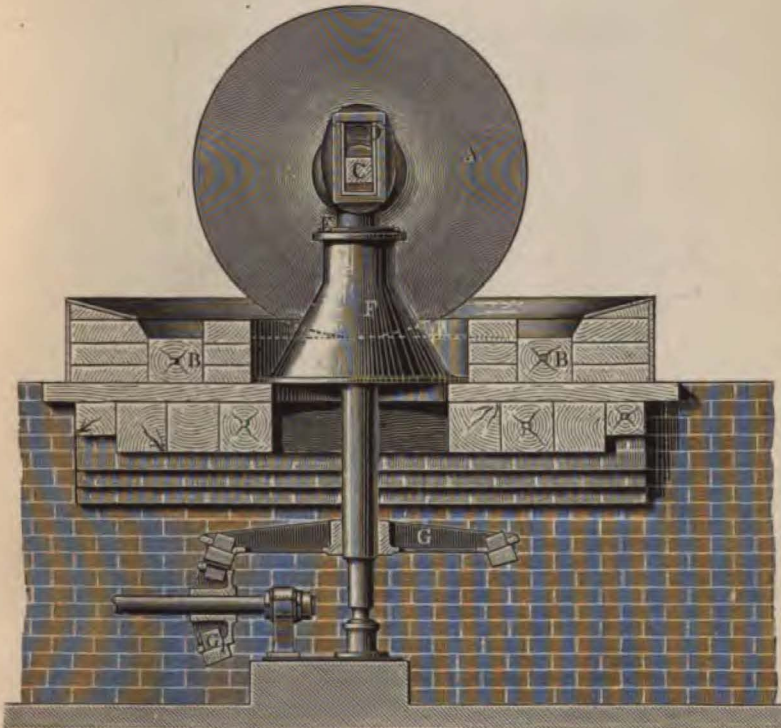

FIG. 89.—One-25th full size.

of 4 feet 8 inches in length, a charge of 132 lbs. is used, and 220 lbs. in those of 5 feet 2 inches in length. They are worked for 10 hours with 330 lbs. and 550 lbs. of bronze balls respectively, the smaller drums making 27 and the larger ones 29 revolutions per minute. The balls should not be used after their diameter is reduced to below a quarter of an inch (6 millimetres) by wear. In France each compartment of the drum receives a charge of 80 to 110 lbs., and 132 lbs. of bronze balls of  $\frac{1}{4}$  inch diameter. The velocity varies from 20 to 25 revolutions per minute. The time of



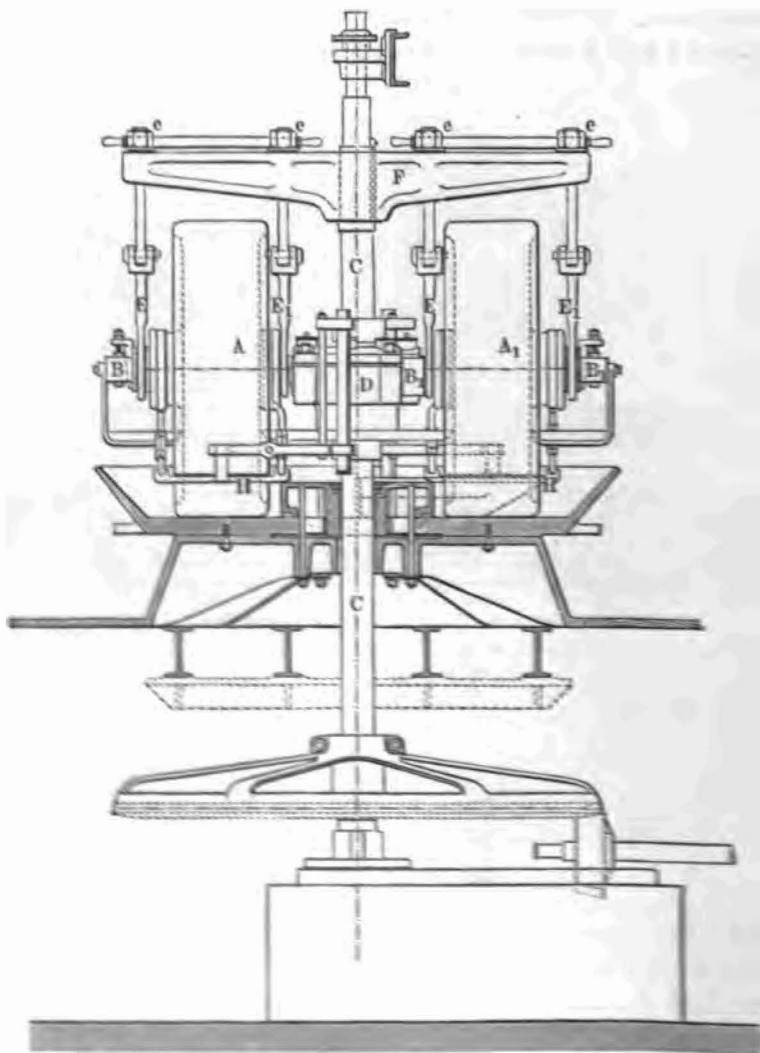

FIG. 9. — *Vertical Engine*

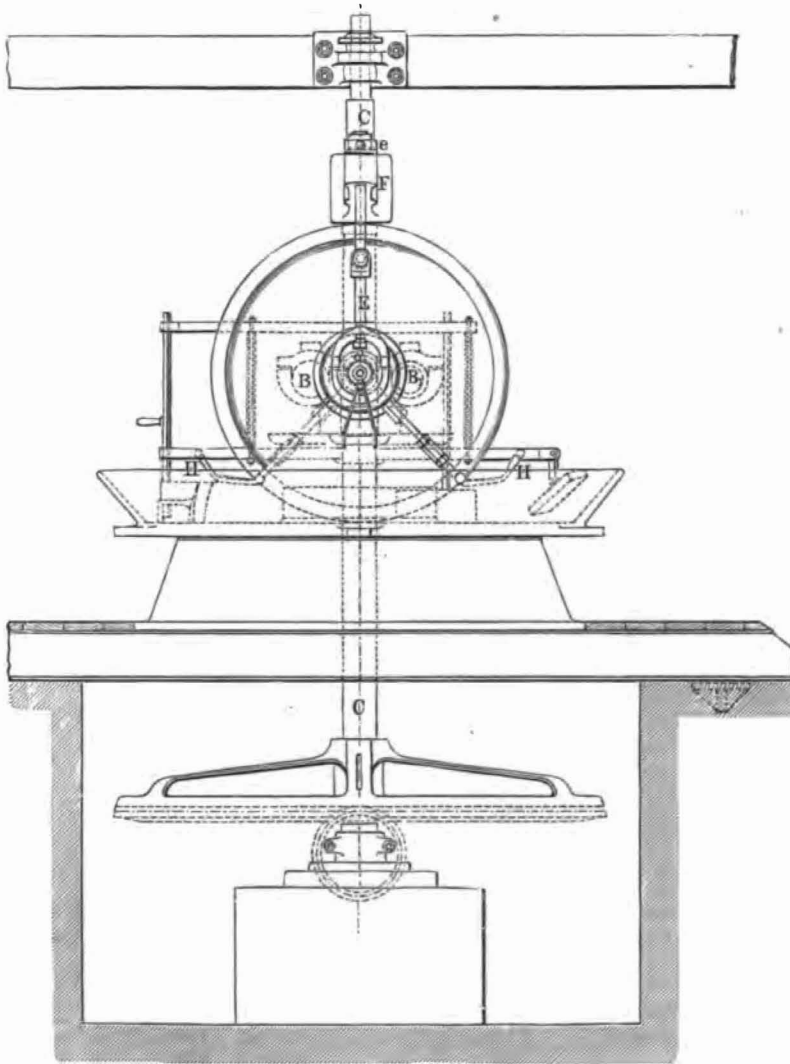

FIG. 91.—One-38th full size.

mixing is from  $1\frac{1}{2}$  to  $2\frac{1}{2}$  hours. In Switzerland the charge is as follows :—

	SALTPETRE.	SULPHUR AND CHARCOAL.	TOTAL NUMBER OF REVOLUTIONS.
For sporting powder ...	187	33	4000
For rifle powder ...	176	44	3000
For cannon and blasting powder ... ..	176	44	1000

The speed is 15 revolutions per minute, and 55 lbs. of box-wood balls of  $\frac{3}{4}$  inch diameter are used in the drum. At Spandau and in Switzerland the charge goes from the drums to incorporating or to stamp-mills.

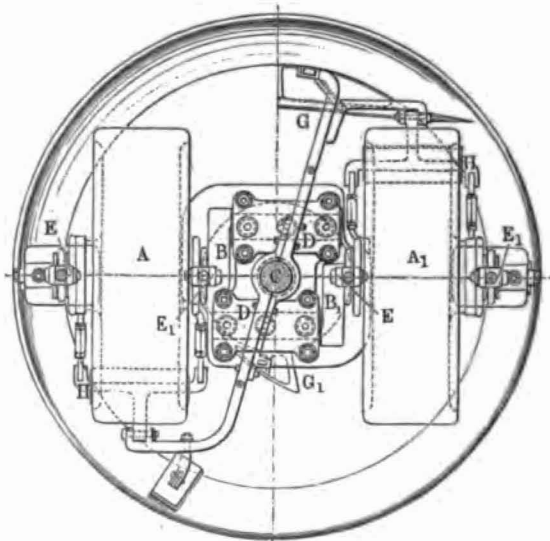

FIG. 92.—One-38th full size.

Mixing in incorporating-mills has of late come more and more to the front. They are, as a rule, similar to the pulverizing-mills already described. The exceptions are, amongst others, those designed by William Klüppelberg and by Uhland. Figs. 88 and 89 show a typical mill of this kind. The bed (B) consists of oak-wood blocks set on edge, by which the danger of an explosion from the runners (A, A<sub>1</sub>) dropping suddenly on to the bed after having passed over a lump is avoided. As will be seen from the drawing, the shaft (C) is square, and can move vertically up and down in the housing (D, D<sub>1</sub>). In case the runner has to go over a hard piece on the bed, it will lift on one side. The driving is done from

below, and, in order to prevent the powder from falling through, all communication with the driving-gear (G, G<sub>1</sub>) is cut off by means of the stuffing-box (E) and the conical centre-piece (F).

Gruson tried to overcome the danger arising from the runners bumping on the bed by suspending them on the vertical driving-shaft, in such a manner that at their lowest position there was always a certain suitable distance between them and the bed. Such an incorporating-mill is illustrated in Figs. 90, 91, and 92. The two runners (A, A<sub>1</sub>) are fixed on to two independent shafts (B, B<sub>1</sub>). These are carried by a cross-head (D) which is fixed on to the main shaft (C), thus ensuring the parallelism of the runners. The suspension is done by means of two rods (E and E<sub>1</sub>) on each side fixed to the cross-head (F). The minimum distance from the bed is regulated by means of nuts (e) on the suspending-rods. Two ploughs (G and G<sub>1</sub>), fixed on wrought-iron frames, revolve with the main shaft, and constantly turn over the charge towards the runners. Each runner is fitted with a scraper (H), which prevents the powder from being thrown out from the bed. The runners, which are ground and polished, are made of chilled cast-iron, in order that the running surface may keep quite smooth. Gruson's incorporating-mills have a bed of 7 feet diameter, and runners 5 feet diameter by 1 foot 7 inches wide, weighing 5½ tons each. They make 9 revolutions per minute, and work with a charge of from 110 to 165 lbs. In former times incorporating-mills with stone runners were used in Great Britain, but they are now quite obsolete. The English incorporating-mills have a cast-iron bed of 7 feet diameter, with runners 7 feet in diameter by 15 inches wide, which weigh about 4 tons, and make 8 revolutions per minute. In France the incorporating-mills have runners of 5 feet diameter and 20 inches wide, weighing between 5 and 5½ tons. The charge is 55 lbs. In Great Britain the maximum charge permitted is 50 lbs. for rifle powder, and 60 lbs. for cannon powder.

The green charge is spread as finely as possible over the bed by means of a wooden rake, and moistened with distilled water. As the incorporation continues the charge becomes drier and has to be moistened again from time to time, to prevent dust arising; on the other hand, there must not be too much moisture, as the mass would then cake on to the runners. The time for incorporating varies with the kind of powder. In Great Britain it is 5½ hours for rifle powder, and between 2 and 3 hours for cannon powder. In France, the proportion of moisture is kept at about 6 to 7 per cent., the time of incorporating being 2½ hours.

In Switzerland, after the charge has been transferred from the drums to the incorporating-mills, it is treated as follows :—

	CHARGE.	TOTAL REVOLUTIONS AT 5 TO 10 PER MINUTE.
Sporting powder ...	44 lbs.	1000
Rifle powder ...	88 „	1000
Cannon powder ...	110 „	300

At Spandau 66 lbs. charges are worked for from an hour to an hour and a half, with the exception of rifle powder, which is worked rather longer. The charge is kept sufficiently moist for it to contain from 3 to 4 per cent. of moisture when it leaves the mill.

The longer black powder is treated in incorporating-mills the more intimately it is mixed. At the same time the density of the charge decreases up to a certain point, which enables it to be more easily pressed, and a more solid grain, which ignites more rapidly, and is less liable to be damaged in transit, is obtained. The velocity of the runners is not unimportant, since certain English observations show that a few quick revolutions are more advantageous than a larger number of slower ones, and that a low speed cannot at all be compensated for by a greater number of revolutions. The following observations made at Spandau show in what proportion the density of the powder decreases during mixing :—

TIME OF MIXING.	SPECIFIC GRAVITY.
1 hour 48 minutes ... ..	1.63
2 „ 20 „ ... ..	1.42
5 „ 24 „ ... ..	1.36
7 „ 12 „ ... ..	1.36
9 „ 36 „ ... ..	1.30

In the same way the gravimetric density of the charge varies. According to French experiments it was after—

1 hour	0.394	7 hours	0.338
2 „	0.368	8 „	0.344
3 „	0.355	9 „	0.352
4 „	0.342	10 „	0.357
5 „	0.340	11 „	0.356
6 „	0.337	12 „	0.357

Incorporating-mills frequently explode, but the cause is not yet fully understood. In many cases the charge cakes into a hard mass over which the runners jump, and fall down through a certain, although small height. In this case a spark may be created, or the gunpowder subjected to strong mechanical vibration.

For this reason Gruson made his double suspension-rollers, and Klüppelberg his wooden bed. Opposed to these explanations there is the fact that very often incorporating-mills explode immediately after the charge has been watered. Sometimes it happens that the mill explodes when it is stopped, and it seems as if by the sudden starting and stopping sufficient mechanical vibration was concentrated in one point to produce explosion. It may also happen that the steam-engine or water-wheel working the mills makes a small jerk after having stopped completely. This is due to the valve of the steam-engine or the shutter of the water-wheel not having been closed tightly. In many cases the cause of the explosion will be found in the fact that the continuous friction on a

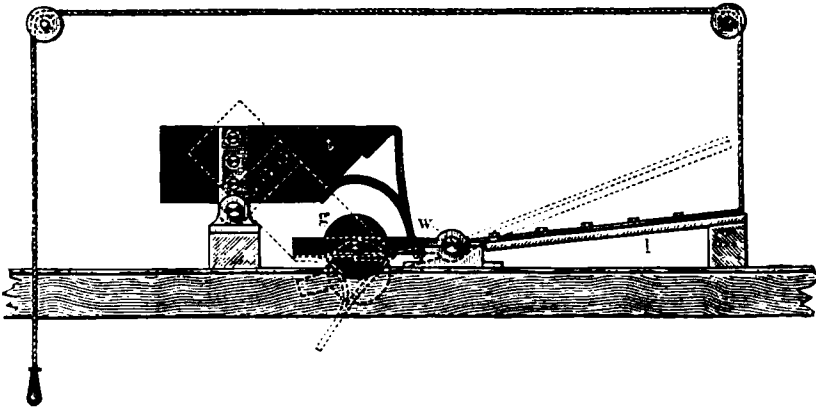

FIG. 93.—One-40th full size.

mass containing larger quantities of sulphur generates an electric charge, which under given circumstances may accumulate until a spark is formed. For this reason Gütler provided his incorporating-mills with an earth connection, and this is very desirable in general with all machines for black powder.

At Waltham Abbey and in every British factory there is a special apparatus for drenching the incorporating-mill with a large quantity of water immediately the charge ignites. The apparatus is so arranged that water is poured over the charge in all the incorporating-mills simultaneously. This contrivance, which is called the "drenching apparatus," is illustrated in Fig. 93. It consists of a flat board (l) turning round an axle, and kept in position by a counter-weight (g). A hinged water-tank is so connected with it that if the board is moved in the least degree, the

water-tank turns over into the position shown by the dotted lines, and pours its contents down over the incorporating-mill. The boards over all the incorporating-mills are connected with each other by means of a horizontal shaft (w), so that in case of an explosion of one mill, all the others are at once drenched. In case of emergency the apparatus can be actuated by hand, by means of a rope.

(§) *Pressing the Cake.*

As previously said, caking and mixing are sometimes done simultaneously when stamp-mills are used, and formerly this was the case with incorporating-mills. When drums and incorporating-mills are used, the caking is as a rule done separately. If the caking is done in drums, the mixture is previously moistened; formerly this was done by small watering-cans, and later on by special tipping apparatus. At the present time re-working of the cake in incorporating-mills after it has been treated in drums is preferred. Caking by means of bronze edge-runners was formerly in use in France, but has since been discontinued.

Before the powder is placed in the press it must again be broken. This is done in the "breaking-down" machine. First of all very large pieces are broken by wooden mallets, so that they can be put into the hopper of the breaking-down machine. Such a machine, as supplied by Hick, Hargreaves and Co., of Bolton, to the Royal Gunpowder Factory, Waltham Abbey, is illustrated in Fig. 94. It consists of a brass frame on which two pairs of grooved brass rolls (A and B) are supported. The rolls are placed in sliding bearings connected by counter-weights (c), which exert a pressure of about 1 cwt.; so that in case any hard body accidentally gets between the rolls, they move apart. On the lower end of the machine there is a hopper (D), which will hold about 500 lbs. of cake. An endless band moves over two tightening rolls (E), one of which is fixed to the end of the hopper, and the other to the top of the rolls. Leather straps are sewn across this band at distances of about 4 inches, forming ribs which carry up the pieces of cake from the hopper on to the top pair of rolls. The broken cake falls on to the second pair of rolls, where it is crushed to a fine flour, which falls into wooden boxes underneath. The tension of the band is regulated by means of the screw (F). Any pieces that are too large to pass through the rolls fall down an incline (G) into the box (H). The machine used at Spandau is almost identical,



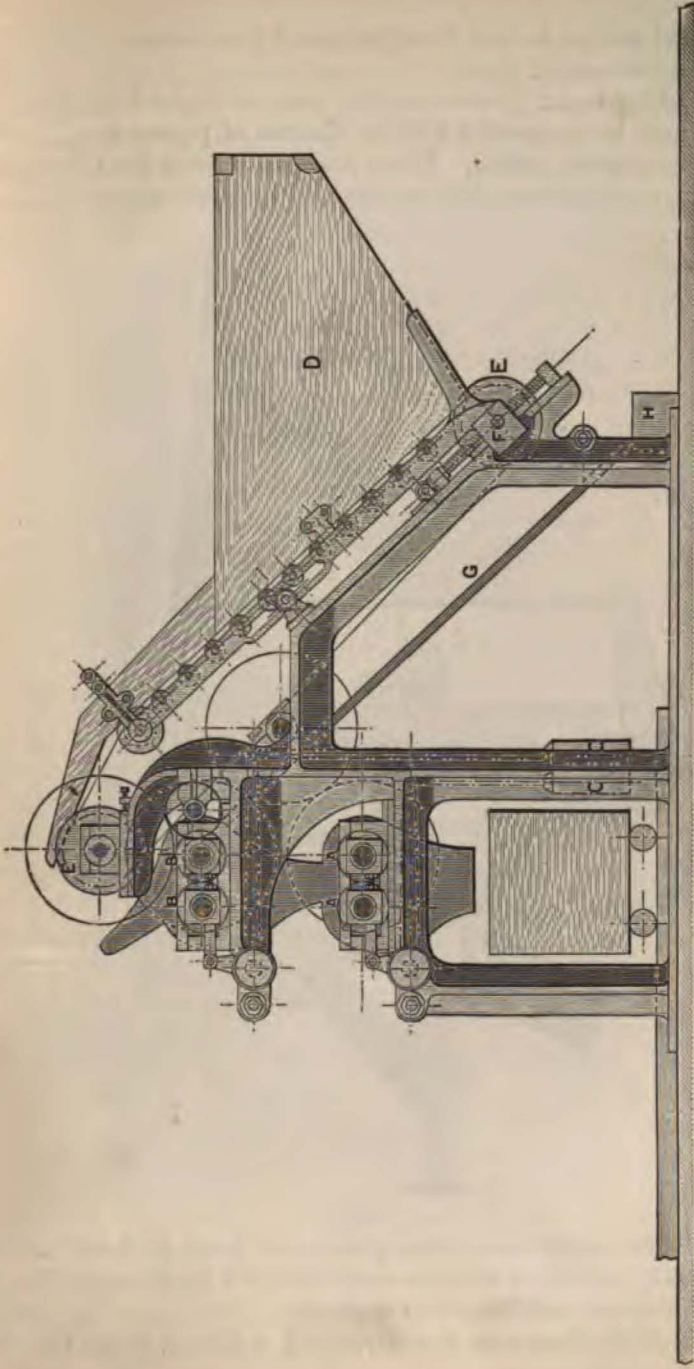

FIG. 94.—One-24th full size.

but the charge is sent through two or three times until it will pass a fine-meshed sieve.

Caking under presses was first done in England in 1784, but it cannot be ascertained whether the use of presses was invented in that year or earlier. Three kinds of presses have been used—viz., screw-presses, roller-presses, and hydraulic-presses.

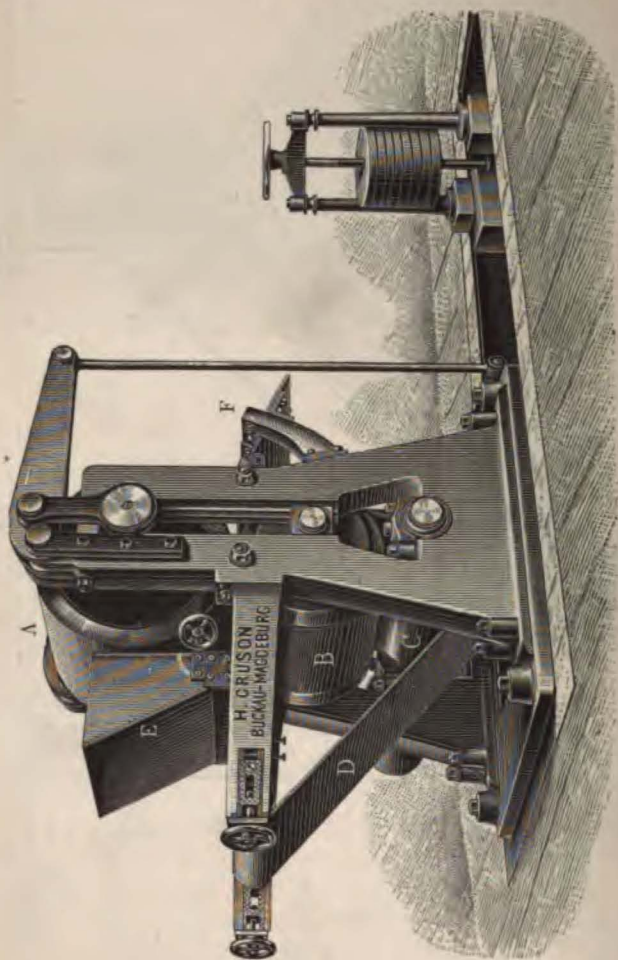

FIG. 95.

Screw-presses have quite gone out of use. In Sweden it was formerly prescribed that the spindle should be at least 106 millimetres (about  $4\frac{3}{8}$  inches) in diameter.

Roller-presses were first introduced in France, where they were

known under the name of "laminoirs." They originally consisted of two rolls, but now there is, as a rule, a third one. Germany is the only country in which roller-presses are still to be found. As a rule, pressing is now done by hydraulic pressure. Fig. 95 shows a roller-press as made by F. Krupp, Grusonwerk, at Buckau. It has three rolls carried in cast-iron side-frames: the lower one (C) is of cast-iron, and drives the middle one (B), which rests on it. B is made of paper, while the top roll (A), called the pressure-roll, is of chilled cast-iron, and rests on B. An endless band (D) carried by three rolls passes under the hopper (E). It passes between A and B, which can move vertically in the side-frames. Pressure is applied to the top roll (A) by means of a weighted lever, placed under the floor, and acting on the shaft carrying A. The weight and lever are arranged to give pressures up to 5 tons. The endless band can be tightened by means of the adjusting screws on the left. As the band passes the hopper it receives a continuous stream of powder, which it carries under the rolls and out on the far side in the form of cake. As the latter issues from the rolls its edges are trimmed by adjustable knives (F). In other presses the pressure between the rollers is set up by a long lever moved by means of a block and falls.

The hopper is first filled with moistened powder and the feed-shutter lifted up about  $1\frac{1}{4}$  inches. The chief work of the man attending to the press is to see that the hopper is kept filled with powder. The cake as it issues from the rolls is about  $\frac{3}{8}$  inch thick; it breaks off by its own weight and falls into a box placed below to receive it. The material trimmed off from the edges by the knives is at once broken by wooden mallets and returned to the hopper.

The smaller the number of revolutions made by the pressure-roll, the greater is the gravimetric density and the specific weight of the powder, whilst the thicker the powder-cake and the more dust introduced the smaller is the gravimetric density. In order to control the revolutions of the shaft of the pressure-roll, an index-dial and pointer are provided, and the pressure-roll made to make one revolution in about 12 minutes. The output of the press is in summer about a ton, and at other times about three-quarters of a ton of cake. The powder loses  $1\frac{1}{2}$  per cent. of moisture in summer and 1 per cent. at other times whilst being pressed.

The general principle of a hydraulic-press will be considered later on, when dealing with compressed powder. It may, however, be pointed out that in compressing any explosives it is

not now the practice to allow the water to pass straight from the pump, but to feed the presses from an accumulator.

Originally the presses for the production of powder-cake were constructed as shown in Fig. 96. A box *k* made of oak, 2 feet 6 inches square by 2 feet 9 inches deep, was used for pressing the

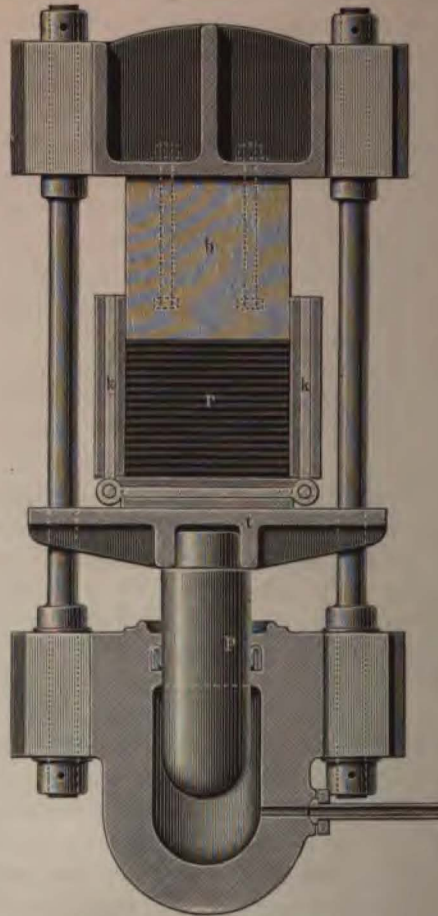

FIG. 96.—One-36th full size.

powder in. Three sides of it were hung on strong brass hinges, and would be turned down, for filling, and secured by suitable fastenings to form a strong box when pressing. To charge, the box was removed from the press and brass or copper plates put in, held at their proper distance apart by brass distance-strips. The

box was placed on its side so that the plates were vertical, and about 800 lbs. of meal powder put in between them and rammed in tightly with wooden rods. The distance-strips were then withdrawn and the side (*i. e.* the top in the charging position) firmly secured. It was then transferred to the press table by an overhead traveller, where it was set in its proper position so as to be true with the wooden pressing-block on the head of the press. A scale painted on this block served for measuring the pressure

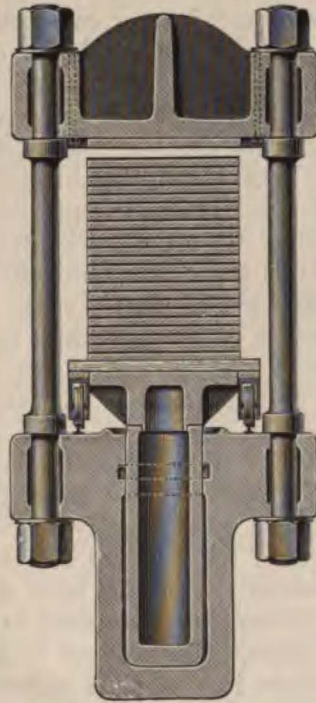

FIG. 97.—One-36th full size.

applied by noting how far the block entered the pressing-box. This method of controlling the pressing operation was found to be more satisfactory than trusting to readings of the gauge on the hydraulic cylinder, as the resistance the powder-meal offers to compression varies with the moisture it contains and with the hygrometric state of the atmosphere. By means of the scale these variables could be allowed for, by using different amounts of compression according to the time of year and state of the atmosphere.



Presses of this kind went out of use on account of their being too dangerous. After it had been pressed the cake adhered so firmly to the sides of the box that it was frequently necessary to loosen it by striking the latter with heavy mallets. The weight of such a heavy brass-bound piece of apparatus also made it difficult to manipulate, and as it has been found that a perfect cake can be obtained without a box, the above method of pressing is now no longer used. The construction of a press such as is ordinarily used is shown in Fig. 97. The head and bed-plate are made of cast-iron or cast-steel. A four-wheeled truck running on rails receives the layers of powder and the plates. Formerly brass plates were exclusively used, but have been replaced by ebonite ones, which are now almost universally preferred. The plates are about 1 foot 8 inches by 2 feet 4 inches, and about  $\frac{3}{8}$  inch thick. In charging the press a plate is first put on to the carriage, and round this is put a wooden frame, which is deeper than the thickness of the plate. The powder is put into this frame, smoothed off by means of a flat lath, and a second plate put on the top of it. The frame is then lifted higher up, and so on, until a whole column consisting of layers of powder-cake and pressing-plates is built up. The carriage is then run on to the table of the press, and the pressure applied.

The compression lasts from 30 to 40 minutes. The work is done slowly and the pressure eased off and re-applied several times in order to obtain great density without using excessive pressures. The edges of the cake are, however, less compressed than the middle, because the powder layer can fall away round the edges. It is therefore always necessary to cut off from  $\frac{3}{4}$  inch to 1 $\frac{1}{4}$  inches at the edges. The pressure applied is between 375 and 450 lbs. per square inch of plate surface, according to the fineness of the powder and the amount of moisture it contains, and also to the state of the atmosphere. The coarser the mass and the less moisture it contains, the more difficult it is to press properly. A pressure of 375 lbs. per square inch applied for from 1 $\frac{1}{2}$  to 2 hours will produce a cake with an average density of between 1.700 and 1.800 from powder incorporated in incorporating-mills and containing about 3 per cent. of moisture.

In erecting hydraulic-presses care must of course be taken to have all pipes perfectly tight, and an arrangement should be provided for automatically shutting off the accumulator when the maximum pressure is reached. For the latter purpose either a weight and

levers which, at a certain pressure, lift the suction-valves of the pump and thus stop their action may be used; or, if accumulators are used, the weights on reaching a certain height touch a valve by which the water is let out from the cylinder; or a safety-valve on the pump is lifted by means of a chain running over pulleys.

As soon as the pressing is finished, the water is let out from under the ram of the press, which then drops, the carriage is run out on to the rails, and the column of cake is taken to pieces, which is easily done.

Ebonite plates are decidedly preferable to those of copper, because they are not so easily bent out of shape and always retain a plain smooth surface, and also because they have sufficient elasticity to transmit the pressure evenly all over the layer of powder, even should they get out of the horizontal. On the other hand, they have the disadvantage of becoming easily electrified; in fact, alternate layers of ebonite and powder really form an electric pile. It is quite possible that by excessive friction, and still more so in the case of a thunderstorm, the whole pile may become charged with electricity. A case came to the author's knowledge where a workman, just as he had finished charging the press and had opened the water-pressure valve, saw a thunderstorm approaching. According to his instructions, he left the building, leaving in the meantime the powder under pressure. After the thunderstorm had passed over he returned to the house, and was about to discharge the press when it exploded. Before his death the man stated that when he was about to empty the press a spark about four inches long passed from it to his finger. This points to the advisability of providing presses with an earth connection in order to prevent accumulation of electricity.

With hydraulic-presses it is of course necessary that the cup-leather between ram and cylinder should be kept in proper order, so as to ensure uniform pressure, and also that after pressing the ram should not be allowed to drop suddenly, as it would almost invariably strike a hard-blow on powder-dust lying on the press.

In the ordinary manner of pressing, some layers are more compressed than others, since, on account of the pressure being transmitted from below to the head through the powder, it is slightly greater at the top and bottom than in the middle. These differences in density of the cake are partly removed by the subsequent graining and polishing.

If the various methods of manufacture are considered, it is



difficult to assign the relative value to each, since they all have the same object, although the way in which this is obtained varies. Yet it can hardly be doubted that the cake made in stamp-mills is the most inferior, since it can never be so uniformly worked, and certainly does not obtain such a great density as that made in presses. Consequently it will more easily form dust, and will give insufficient or too unequal velocities for modern rifles. The use of drums and incorporating-mills are probably of equal value. With both an intimate mixture can be effected, as it is only a question of the time of working. Nevertheless, mixing in drums has recently been again resorted to, especially for sporting powders, because it is done more rapidly and the charge is less moist (it even loses moisture at the end), with the result that, in the same time, a more intimate mixture takes place. Comparative experiments made in the powder factory of Fossano in Italy, with French and Italian powders, and with sporting powders made in Italy by both methods, confirmed this. The powder made in drums gave in both cases a greater regularity on shooting. As already mentioned, it has been found in Great Britain that powder made in drums and pressed in hydraulic-presses gives the best results, but for economical reasons this method is not always adopted.

#### (b) GRANULATING.

Originally black powder was only used in the form of dust, and the date when grain powder superseded the dust is not accurately known, though we find mention of granulating as early as 1445. In a manuscript of that year on artillery, it is said that the lumps coming from the stamps are crushed to clods, and that clod powder propels further than ungranulated powder. Originally, only rifle powder was grained, and not cannon powder, according to Tartaglia ('Quesiti ed inventioni diverse,' 1546). The same fact is related in 1540 by Biringuccio, in his 'Pyrotechnia.' At the beginning of the seventeenth century all powder was granulated. It may be remarked that in 1556 the Turks had no knowledge of granular powder.

Formerly, granulating was done by breaking the powder with wooden mallets, putting it on to sieves, and crushing the pieces of powder through them by means of a small roller. Later on the roller was replaced by wooden discs, the sieve being moved by hand. The bottom of the sieve consisted either of wire netting or

a perforated iron plate, or of animal parchment, the meshes being originally fairly wide.

Thus Boillot in 1598, in his 'Modelles artifices de feu,' says that the grains for large guns were the size of a pea, and as thick as lentils for smaller guns. Later on, smaller dimensions were adopted. To simplify the granulating, the sieves were put on to a wooden frame, as a rule three or four side by side, and in order to give a shaking movement to the frame, it was suspended from the ceiling by means of cords. The roughly-broken cake was placed on to the sieves together with a lens-shaped disc of *lignum vitæ*, or other hard wood. The discs were  $8\frac{1}{2}$  inches in diameter,  $2\frac{1}{4}$  inches thick in the middle, and  $1\frac{3}{4}$  inches at the circumference. The various grains fell into a box placed below the sieve, and were subsequently sorted by being passed through sieves of brass wire. In some factories there were other sieves placed below the one used for granulating in order to do the granulating and sorting in one operation.

Side by side with this process, another one on the principle of the shaking-machine used in flour-mills was adopted. The frame was shaken by means of water-power, and the grains falling on to it came on to an inclined sieve with meshes of a certain size. Grains that were too large rolled over the sieve, which was also shaken, into a box below, whilst those grains which were smaller than the meshes of the sieve fell through on to a second sieve of smaller meshes, where the same process was repeated.

Between 1815 and 1829 granulating between two metal rolls was used at the powder factory of Neisse. The grains were sifted out from the broken mass, those that were too large being passed in through the rolls again, whilst the meal powder formed was again pressed into cake. Powder is still granulated in German factories in a similar manner with *lignum vitæ* rolls, and then sorted in sieves.

In many German and French factories the graining machine of Lefebure (*grenoir à retour*) is used. Figs. 98 and 99 show the form of this machine, as used at Spandau. A wooden frame (A) is fixed to the ceiling by means of 12 copper bars (a), which move on hinges. In the centre it has a bearing (d), through which passes a vertical iron-crank (e), actuated either from below by cog-wheels, or from above by a pulley. In the latter case the shaft is carried in a foot-step. In this way the whole frame, and with it the sieve arrangement, receives a circular, though not a rotating movement. On the circumference of the frame there are 12 holes with the same

number of granulating-sieves (c). They are made of oak staves with copper hoops, and are  $21\frac{1}{8}$  inches in diameter, and each contains three sieves; the upper (A, Figs. 100 and 101), in which the broken

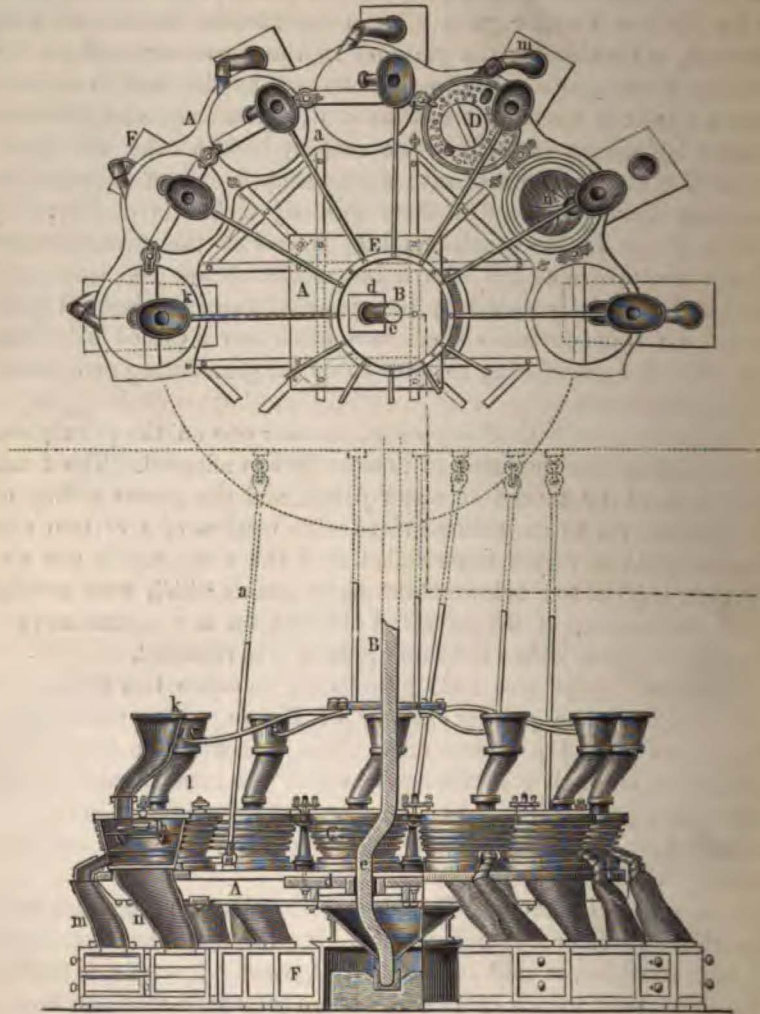

FIGS. 98, 99.

cake is crushed to grains, the middle or granulating-sieve (B), and the lower or dust-sieve (c), resting on the bottom (D). The frame is fitted with a wooden ring lined with cloth where the dust-sieve rests on it, for the purpose of fixing the whole sieve. The bottom

of the upper sieve is of sheet-brass, with holes  $\frac{1}{4}$  inch wide, and on its outer circumference it has two large openings, as will be seen from the illustration. From each of these an inclined brass shoot passes down to the bottom of the granulating-sieve in the opposite direction to the movement of the sieve. The larger pieces of cake which are in the granulating-sieve are thrown against these shoots by the movement of the frame, and the centrifugal force carries them back into the upper sieve. The bottom of the granulating-sieve consists of brass-wire gauze with  $\frac{1}{20}$  inch mesh for rifle powder,  $\frac{3}{8}$  inch for large grained powder, and  $\frac{1}{12}$  inch for prismatic powder. The dust-sieve is made from hair, and it retains the grains coming from the granulating-sieve, but lets the dust fall through the leather funnel (n) into the box (F). The bottom sieve for large grained powder has a mesh of  $\frac{5}{8}$  inch.

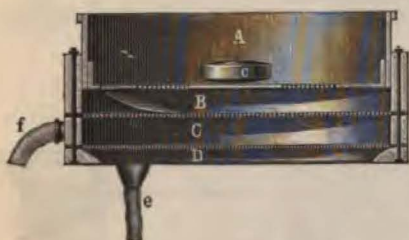

FIG. 100.

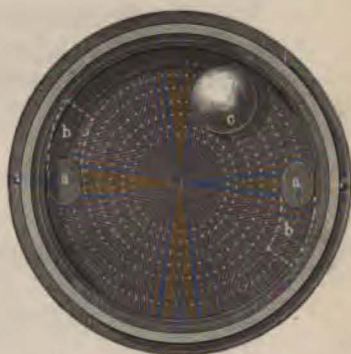

FIG. 101.

The granulating is done by means of a granulating disc (D), which is  $12\frac{3}{8}$  inches diameter, and is made of white beech-wood. The lower face of this is worked out to form rays. It is loaded with lead— $8\frac{1}{4}$  lbs. in weight for rifle powder, and  $3\frac{1}{4}$  lbs. for large grained powder. If the disc becomes worn-out through friction, it is re-filled with lead. For the purpose of filling the apparatus with broken cake, an iron frame (E) with 12 arms is fixed to the ceiling. In each arm is placed a copper funnel (k), from which a cloth bag (l) with a copper tube goes to each upper sieve, and which can be easily connected to a copper tube on the cover of the sieve. Below each sieve a wooden box (F) is placed to take the granulated material. The dust goes through the lower hose (m) into one drawer of the box, whilst the powder falls through the hose (n) in front of the dust-sieve, into the second



drawer. The machine makes 74 revolutions per minute, and to avoid excessive heating, the lower end of the shaft (e) works in a box filled with water.

Before charging into the hoppers the powder-cake is broken up with wooden mallets, and each hopper receives 1 lb. 10 oz. As soon as the machine is set in motion the disc travels round the circumference of the sieve, revolving at the same time round its own axis. This breaks the pieces of powder, which are also thrown

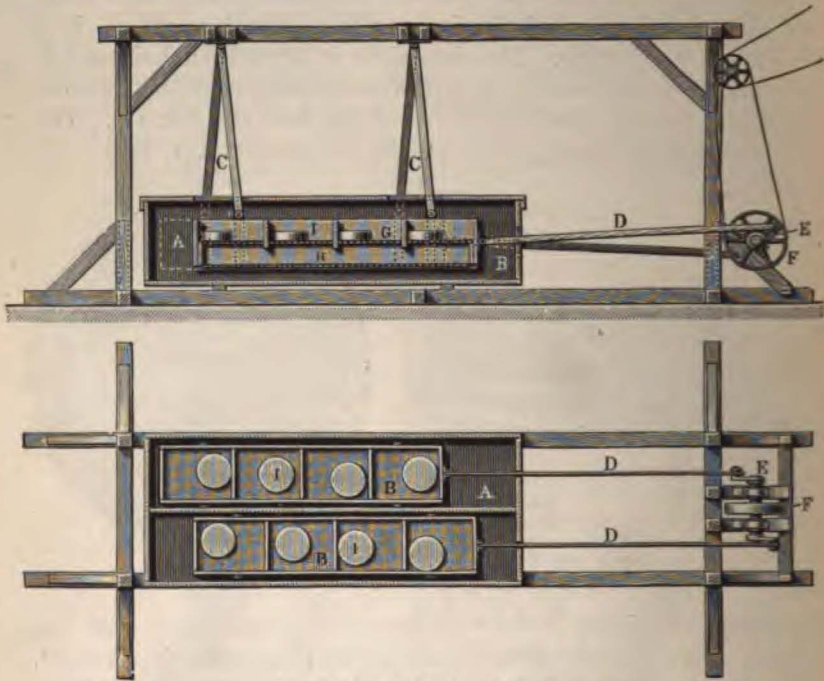

FIG. 102.—One-60th full size.

on to the circumference, and when broken they are pressed through the holes of the upper sieve. The pieces that are too large go back to the upper sieve up the shoot, and are again granulated. The grains and dust go through the hoses into their respective boxes, which must be emptied from time to time. The charging is continued until the dusty appearance of the powder shows that the sieves are clogged. The machine is then stopped, and the sieves replaced by new ones. The clogged sieves are cleaned by brushes, the too firmly adhering pieces of powder, after having been previously moistened, are taken off by wooden scrapers.

The grains, which still contain about 8 per cent. of moisture, are now placed in tubs and taken to the drying-house. The dust, which has the same composition as the cake, is brought to the moistening apparatus, and after having been wetted with 2 per cent. of water, is again pressed.

A granulating machine on the same principle is used in Switzerland, and in some English and German factories. A wooden box (A, Fig. 102) is placed on a frame, and in it there are two square frames (B), with several divisions, carried from the ceiling by four swinging bars (C), or by wooden spring-beams. A connecting-rod (D) is fixed at the end of the frame, and is attached to an eccentric (E), on a shaft which is revolved by means of a pulley (F). In each of the divisions of the frames (B) there are two sieves, placed one above the other, one (G) being a coarse sieve, and the other (H) a granulating one. A lignum vitæ disc (I), about 2 lbs. in weight, is placed on each upper sieve, and is shaken to and fro as the frame moves. Each compartment is about 2 feet long and 1 foot 8 inches wide. This form of sieve produces a good deal of dust, and requires properly boxing in.

The yield of the Lefebure granulating machine depends upon the speed of the apparatus, the weight of the disc, the density of and moisture in the cake, and also on the size of the grains made. A machine with eight sieves yields between 154 and 176 lbs. per hour, and the percentage yield is between 47 and 63 per cent. with rifle powder.

In France, a drum invented by Maurey is used for granulating cannon powder. It consists of two wooden discs connected with each other by means of cross-pieces and covered with two brass sieves placed one above the other. The inner sieve is of  $\frac{9}{32}$  inch mesh, and the outer one of  $\frac{3}{8}$  inch. They are stretched by means of cords. From 110 to 132 lbs. of hard wooden balls, 2 inches in diameter, are placed together with the material to be granulated into each drum, which makes 30 revolutions per minute. The impact of the balls on the material breaks it up and rubs it through the sieve, whence it falls into a movable tub on wheels. The dust and grains that are too fine are removed by means of hair and leather sieves of  $\frac{1}{8}$  inch mesh. Granulating in this drum yields 484 lbs. of powder per hour if driven by hand, or 660 lbs. if driven by power. The yield of serviceable grains is about 40 per cent.

For the manufacture of round blasting powder a special granulating drum is used in French factories. This method was

invented by Champy, who, in 1795, showed experimentally at Vincennes that a moist mass of powder can be made into grains by mere shaking. Fig. 103 shows this apparatus. A wooden drum (A), 5 feet 3 inches in diameter and 2 feet wide, moves round

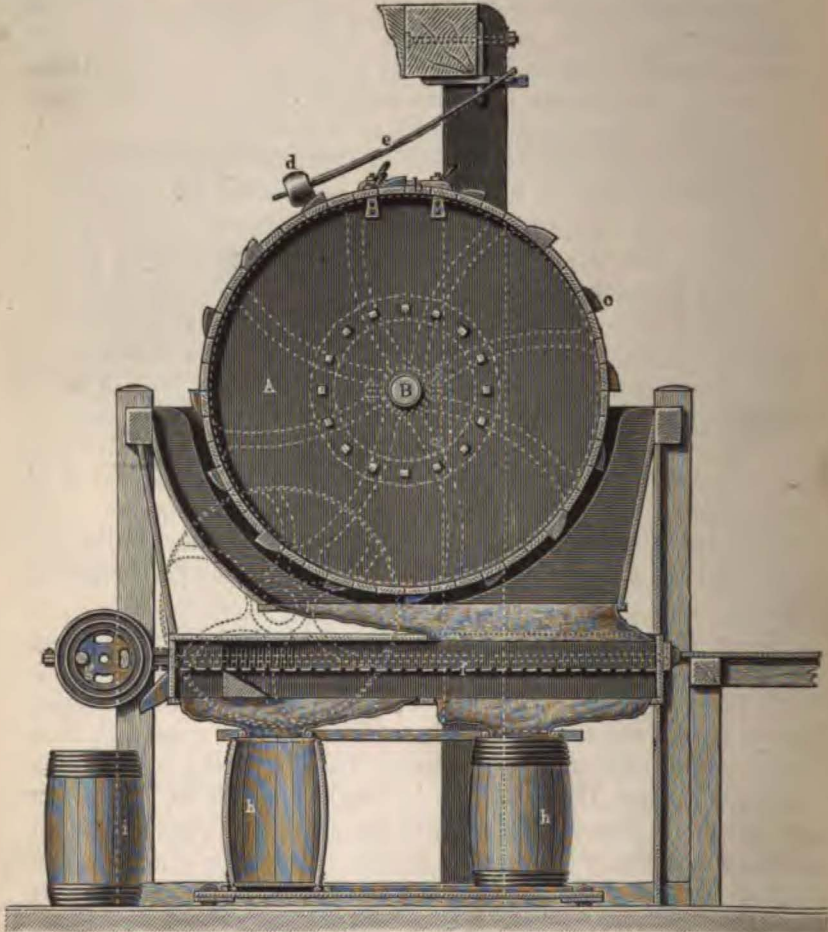

FIG. 103. — One-32nd full size.

the horizontal iron axle (B), which goes through one of the two wooden ends of the drum, and is fixed there by means of a cast-iron plate. The other end has at the centre a round opening 1 foot 10 inches in diameter, through which the powder is introduced. A second opening (b), on the circumference, serves for introduc-



ing powder-dust and for discharging the granulated material. It is 1 foot 7 inches long by 8 inches wide, and is closed by a door with bolts and wing-nuts. On the outside 15 tappets (c) are fixed, which alternately lift and let fall a small wooden mallet (d), fixed above the drum by means of a spring (e). Inside the drum is a tube containing 25 capillary holes, over which a sliding brass tube is placed, and by turning the latter the holes are closed, and powder-dust prevented from getting into them after moistening the charge. The tube continues through the drum, and is connected with a water-tank by means of a pipe and tap. The quantity of water used is shown by a float and index on the tank. 220 lbs. of waste or fine grains are introduced through the door (b) on the circumference of the drum. The holes in the inner of the two tubes are closed by turning the outer one, and the tank filled. The drum is then revolved at the rate of 10 to 12 revolutions per minute, the tap of the water-tank opened, and the outer tube turned so as to open the perforations of the inner one, from which the water issues in a fine spray and moistens the grains. The water is left on until the float shows that 11 lbs. of water have run into the drum, which takes about 8 minutes. The outer tube is then closed, the tap of the water-tank shut off, and 110 lbs. of powder-dust put into the drum in small quantities by means of a wooden trowel. The moist grains become covered with a layer of dust, and considerably increase in size; 11 lbs. of water and 110 lbs. of dust are again added, and after 30 or 35 minutes between 220 and 262 lbs. of grains of serviceable size, containing between 8 and 10 per cent. of moisture, are obtained.

As soon as the granulating is finished, the drum is placed with its discharging-hole turned downwards and opened, and the powder discharged on to two sieves (f) in a box placed below. These are shaken to and fro by means of an eccentric (g), making 100 revolutions per minute, and having a stroke of 10 inches. The first sieve retains the irregular pieces, and the second one the good serviceable grains. The dust and the serviceable grains fall into special tubs (h) placed below, whilst the irregular grains are passed by the movement of the apparatus into a third tub.

Granulating by means of rolls has more recently come into general use. Granulating-rolls were invented in 1819 by Colonel Congrève, and are in many respects similar to the breaking-down machine. Fig. 104 shows such a granulating machine. It consists of a brass or cast-iron frame with three or four pairs of bronze rolls. The two lower pairs of rolls are smooth, the middle pair have teeth

of  $\frac{1}{4}$  inch pitch, and the highest pair teeth of  $\frac{1}{2}$  inch pitch. The bearings of the rolls are fitted with counter-weights in the same way as in breaking-down machines, so that grains that are too hard or too large can pass them. The cake is also introduced by

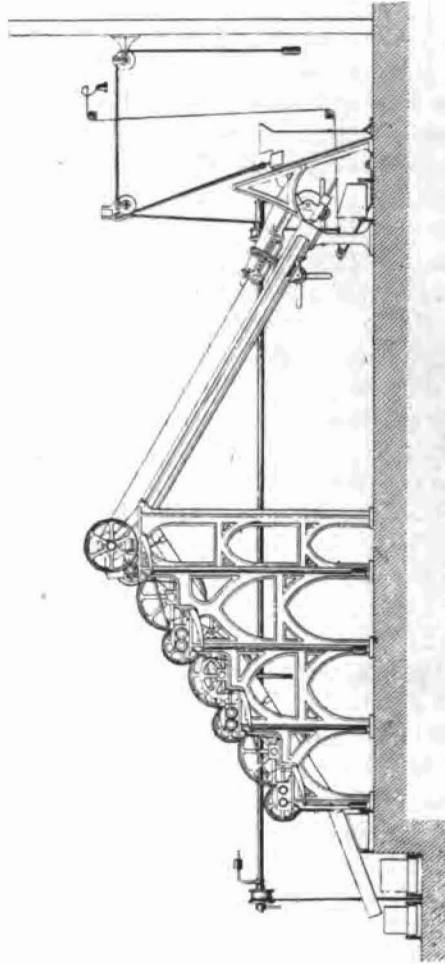

FIG. 104.—One-200th full size.

means of an endless belt, in much the same way as in the breaking-down machine.

Under each pair of rolls, except the last, is a short sieve, which forms a connection with the next pair of rolls. Besides this, there are two long sieves placed below all the rolls, at a distance of

about 3 inches from each other. The upper sieve has 10 meshes to the square inch, and the lower one 20 meshes. All sieves in the machine receive a shaking motion. The grains from the lower sieve pass into small boxes on wheels, whilst the dust from the last sieve falls into a special box. The rolls make 25 revolutions per minute, and the sieves between 130 and 150 strokes per minute. The machine will treat from 3 to 4 tons per day of 24 hours, from which about 55 per cent. granulated powder are obtained when making ordinary cannon powder. Such grains as can be used for sporting powder are sorted out from the dust, which brings the yield of serviceable powder up to between 70 and 80 per cent. of the quantity treated.

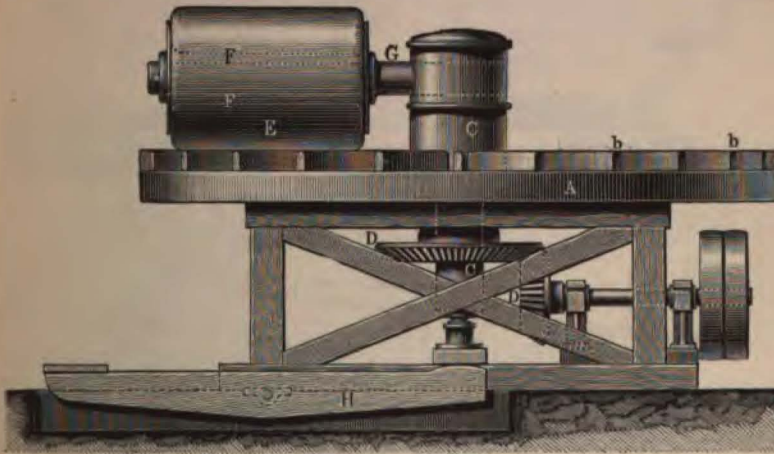

FIG. 105.—One-24th full size.

In France the powder for field-guns is granulated on perforated tables, the holes of which are  $\frac{1}{4}\frac{1}{2}$  inch in diameter. The cake is simply broken by means of wooden mallets with zinc points on the face, the grains falling through the holes of the table.

In Germany and Switzerland the so-called "wet burning," or "Swiss powder," is made by treating the powder on a "rounding table" immediately after it has been granulated. This machine, which is shown in Fig. 105, consists of a wooden table, (A), with radial round-topped wooden ribs (b),  $1\frac{3}{8}$  inches thick and  $2\frac{3}{8}$  inches high. A vertical shaft (c), which is rotated by means of cog-wheels (D), passes through the centre of the table. At right angles to c, and turning with it, is a horizontal arm (g), E is a linen bag,

1 foot 6 inches diameter at the largest part and 2 feet long, with discs at each end. A wooden tube (F) passes along its axis, and the bag is fastened to the discs on the tube, filled with 88 to 132 lbs. of powder, and then slipped on to the arm (g). As the vertical shaft rotates, the bag is rolled round the table across the ribs, and at the same time rotates on its own axis. The shaft (c) runs in a foot-step which rests on one end of a lever; by treading on to the other end the foot-step, and with it the upper cog, can be lifted out of gear, and the bag brought to rest. By the friction of their edges and points, and also by the agglomeration of powder-dust on their surface, the grains acquire a round form. The rounding

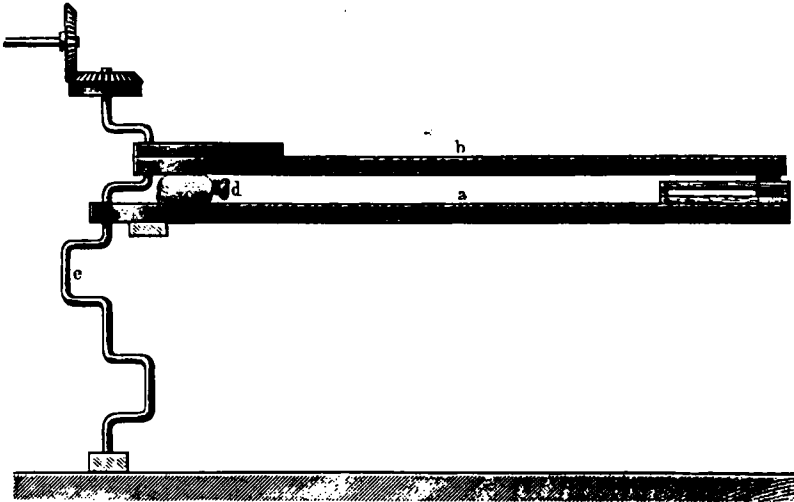

FIG. 106.

bag makes from 12 to 15 revolutions round the table per minute, and the operation lasts from 20 to 30 minutes.

The rounding apparatus used in the Austrian powder factory at Stein is illustrated in Figs. 106 and 107. It consists of three pairs of long tables working like connecting-rods on to the cranks (e). They are arranged in such a manner that the lower table of a pair is stationary, whilst the upper one (b) moves. Through the crank end of the tables an opening is cut, into which six curved hard-wood spokes are fixed. The powder in a linen bag (d), containing 11 lbs., is laid on the spokes (c). In order to do this the upper table is lifted. The operation lasts five minutes, and the powder treated by it is perfectly rounded, and has a

specific gravity of 1.580. One machine will treat  $1\frac{1}{2}$  tons per day.

In Switzerland the rifle powder, after it has been rounded, is dusted like all other kinds of powder.

Hermann Güttler, of Reichenstein, uses a special apparatus for sorting Swiss powder. It consists of a slightly-inclined slotted table, to which light blows are given by means of a cam. The width of the slots depends on the size of grains desired. The action of this apparatus is that round grains fall down whilst the angular ones remain on the table, and it is quite astonishing to see the accuracy of the sizing it effects—in fact, to the naked eye no difference between the grains is discernible.

The advantages obtained by granulating are the following:—First of all the ingredients do not separate from each other, and the proportions of mixing are more safely maintained than would be the case in using black powder in the shape of dust. With

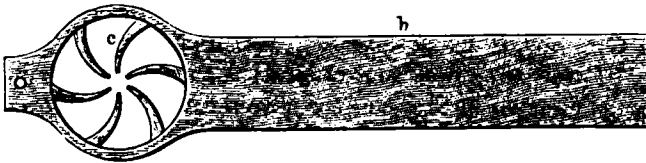

FIG. 107.

the shaking powder gets during transportation, there is always the danger that the single components would settle in layers according to their density if it were in the form of dust. Moreover, granulated powder has the advantage of standing storage better, since a granulated powder is less hygroscopic than that in the form of dust. The absorption of moisture varies according to the fineness of the grains on account of the larger or smaller surface presented, and there is also less danger in carrying granulated powder, since there is no dust to fall through the bags or barrels. Finally, and this is perhaps the chief point, the inflammability of the powder is increased by granulating, since the flame can penetrate more quickly through the mass of powder from the part first ignited on account of the greater interstitial space, than it can in loose dust. With hard-pressed cake the transmission of burning only takes place quite slowly and proceeds in layers.

On comparing the various methods of granulating, it will be seen that granulating, as done in France for blasting powder, gives grains of insufficient density, the outer layers of which consist

chiefly of charcoal, while that part of the mass which is most dense clings to the walls of the drums. The large quantity of water in the powder cannot be eliminated by drying without considerably decreasing the keeping capacity of the powder. Lefebure's granulating machine gives grains that are less regular and uniform than those made in roller granulating machines, the powder having more the form of flakes and splinters. Moreover, the Lefebure machine cannot be used for very hard and very thick cake. In general, the work with a roller-machine is much simpler, makes little or no dust, yields four to five times more than a Lefebure machine at an equal cost, and requires but little greater driving-power.

#### (c) DUSTING, PRELIMINARY DRYING, AND GLAZING.

The treatment of black powder after granulating varies considerably, and it also depends on the method used for granulating.

In Germany, black powder is glazed immediately after granulating. Formerly it was first submitted to a preliminary drying in the open air, or in the so-called preliminary drying-houses. In these the black powder was spread on trays with a lattice bottom, over which wool cloth was laid. From time to time the powder was turned and left on the trays until the moisture was reduced to 3 per cent., when it was dusted in a sieve apparatus of similar construction to the Lefebure granulating machine. In France and Switzerland rifle powder is also glazed at once, since it has already been previously dusted. In Great Britain it is first passed through horizontal cylindrical sieves, similar to those used in flour-milling. After this it is "glazed," the object of which is not so much to make the powder smooth as to break off any sharp angles and points, and to stop up the outer pores of the grain, thus making the powder less sensitive to atmospheric moisture and less likely to deposit dust. The powder also obtains a greater durability by the rounding through the glazing operations.

The glazing-drums used at Spandau are made of oak with two copper tightening hooks. Their diameter is 5 feet 5 inches, and their length  $21\frac{1}{2}$  inches. They differ from the mixing-drums in not having ribs on the inner side of the drum, and in the iron axle not passing through the drum, but ending in a strong iron cross-piece fastened to the circular ends of the drum by

means of bolts. The front part has a circular opening of 1 foot  $7\frac{1}{2}$  inches, with a brass cover. A heavy metal door, the full length of the drum, serves for discharging the glazed powder which, as is the case with the mixing-drums, falls through a leather funnel into barrels placed below.

To control the number of revolutions given to the drum, a speed counter is attached. The drum is charged with 440 lbs. of powder, and makes 8 to 9 revolutions per minute during the first half-hour, and afterwards 16 revolutions per minute. Altogether about 3600 revolutions are made by the drum, which takes about 4 hours. The number of revolutions is increased gradually in order to avoid a sudden development of heat, and the consequent caking together of the powder. In the last half-hour the cover is taken off, so that the steam can escape from the drum. A part of the charge cakes on to the surface of the drum on account of the heat developed. This crust is not taken away before working a fresh charge, as it is said to add to the finish of the powder.

In France the glazing-drum makes 10 to 12 revolutions per minute, and the glazing lasts about 20 hours. The work is so regulated, that for rifle powder a gravimetric density of 0.935 to 0.940 is obtained. The glazing of cannon powder lasts about half-an-hour only, and the gravimetric density is brought up to 0.830 to 0.870. Sporting powder is glazed for from 24 to 48 hours, and blasting powder from 3 to 4 hours, when it should have a gravimetric density of about 0.775. In some German factories glazing-drums of about 5 feet 6 inches diameter and 2 feet  $9\frac{1}{2}$  inches width are used, which have on the ends two holes to let the steam out. These drums make 18 revolutions per minute, and the glazing lasts about 18 hours.

The Swiss glazing-barrels are 2 feet in diameter and 3 feet long. They are charged with 220 lbs. of powder, and treated for from 2 to 3 hours at 12 to 15 revolutions per minute.

At Waltham Abbey drums of 6 feet diameter and 2 feet long are used. They make 9 revolutions per minute, and are charged with 900 lbs. of powder. The glazing takes 6 hours for "R. F. G.," and  $1\frac{1}{2}$  hours for "R. L. G. 2" powder. "Pebble" powder is put into smaller glazing-barrels 5 feet long, 2 feet 6 inches diameter, making 34 revolutions per minute for 4 hours.

It is the process of glazing that chiefly increases the gravimetric density, as is shown in the following table:—



Gravimetric density before glazing	...	...	0·810
"    "    after 4 hours' glazing	...	...	0·833
"    "    "    8    "    "	...	...	0·846
"    "    "    20   "    "	...	...	0·869
"    "    "    25   "    "	...	...	0·878
"    "    "    30   "    "	...	...	0·889
"    "    "    42   "    "	...	...	0·893

## (d) DRYING.

Drying in the open air is, as previously mentioned, rarely resorted to at the present time. If black powder is exposed directly to the sun's rays in summer, it is as a rule dried in 4 hours. A thermometer placed into the black powder rarely shows then a higher temperature than 77° F. If the drying is done in a drying-house without much heat, 8 to 10 days are as a rule required. If there is no hurry, and sufficient room and sun are available, drying in the open air is sometimes of advantage, because with it there is a saving of fuel, and the powder is not materially altered. On the other hand, this method has the disadvantages that the rate of drying varies with the moisture of the air, that on a windy day the powder becomes dusty, and that much handling of it is required. For these reasons artificial drying is now-a-days almost invariably resorted to.

Artificial drying as it has been practised at various times can be classified under four headings :—

- (1) Drying by warm air.
- (2) Drying by steam or hot water.
- (3) Drying by cold, but previously dried air.
- (4) Drying in vacuo.

In 1632 Furtenbach related that drying black powder in copper pans over a fire had been tried, but had been abolished, as men had lost their lives through it. The next idea naturally suggesting itself was to use the radiant heat of a fire, and not to place the powder in its immediate neighbourhood. This was done by placing in the centre of the drying-room a fire, which of course had to be stoked whilst the powder was near it. Since by inadvertence a number of accidents happened, the stove was later on put against one wall of the drying-house with its fire-place in an adjoining room having no connection with the drying-room, the stove being surrounded with a copper jacket. This method of drying has now gone out of use, and is even expressly forbidden by law in nearly every country.

Drying by steam was first introduced in Great Britain in 1780. Copper pans, on to which the powder was placed, formed covers for wooden boxes, or receptacles made from bad conductors of heat into which steam was admitted by means of copper pipes. The temperature was between 129° and 167° F., and the powder was constantly raked over in order to prevent caking whilst being dried.

At present drying is generally done by subjecting the powder to the action of a hot current of air, either in drying-rooms or in special drying-boxes. Drying-rooms permit the treatment of a large quantity of powder at a time and effect the drying slowly, but in a perfectly regular manner, so that the pores of the powder are not opened too quickly, and the powder is therefore less hygroscopic.

Drying in drying-rooms or stoves is in great favour in England. At Waltham Abbey there is a large room, holding about 2½ tons of powder, in which there are open wooden frames containing 8 trays placed one above the other. At the bottom of the frames a series of steam-pipes run along near the floor. The trays are made either of copper or, as now preferred, of wood, and are covered at the bottom with cloth. They are about 3 feet long by 1 foot 6 inches wide and 2½ inches deep, each tray holding about 11 lbs. of powder. Ventilating apertures pass through the roof, and inlet-holes are provided near the floor, so that a continuous current of air passes through the building. The maximum temperature allowed is 125° F. for granulated powder, and 140° F. for cubical powder, whilst prismatic powder is dried slowly at about 95° F. When the stove is charged the heat is gradually increased, and in the same way cooling in the stove itself is also slowly done. The time of drying for granulated powder is between 6 and 12 hours, but with the heating up and cooling down the whole operation of drying lasts about a day.

In Spandau the current of hot air is produced by fans driving a cold current of air over heating coils. The drying-boxes are made of wood 10 feet long, 3 feet 9 inches wide, 3 feet 2 inches high at the back, and 2 feet 7 inches in front. They are closed at the top by a removable frame covered with brass-wire gauze. Over this a cloth is laid, and a charge of 110 lbs. of powder is placed on it. The drying-box contains two hollow copper cylinders of about 1 foot 7 inches diameter and 4 to 5 feet long, each of which contains 16 pipes of 1½ inches bore, open at each end, through which air is drawn by a fan. Steam surrounds the small pipes and heats the current of air passing through them. The steam-cylinder is fitted with an inlet cock and traps for

taking away condensed water. The temperature produced under the cloth is about  $162\frac{1}{2}^{\circ}$  F., which gives an average temperature of  $140^{\circ}$  F. to the powder. In order to avoid the production of lumps, the powder is sifted before being placed on the trays through a coarse brass sieve, and in the meantime spread on drying-plates, being frequently turned over by means of rakes

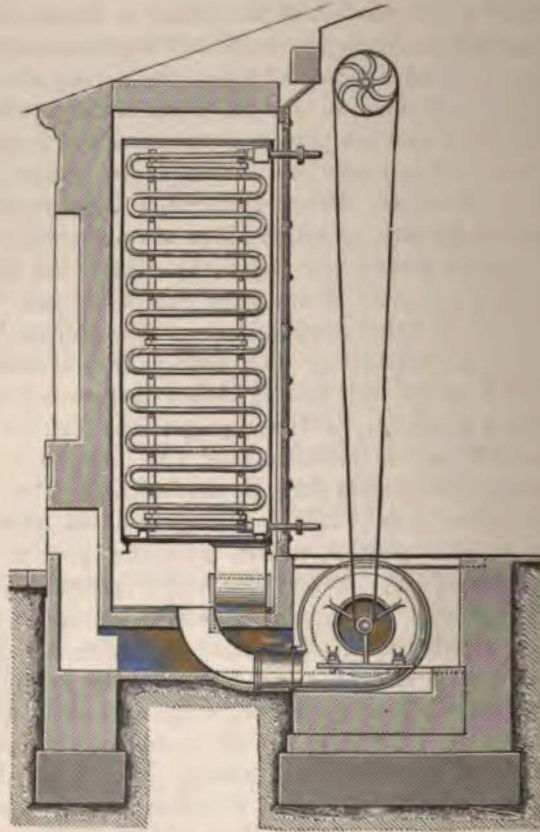

FIG. 108.—One-60th full size.

while drying. Powder containing  $1\frac{1}{2}$  per cent. of moisture takes  $1\frac{1}{4}$  hours to dry. Samples are frequently drawn towards the end of the operation to ascertain when it is finished.

In France, similar drying-boxes of about 6 feet 8 inches in width are used, but they are lined with thin sheet-lead. The boxes have double walls with a space of about 3 inches between

them to prevent cooling. They are made by lining from both sides an iron framework with  $1\frac{1}{4}$  inches tongued and grooved boards. Above this box there is a wooden hood with four openings towards the worker for discharging. In the box itself there are four sheet-copper dampers for the introduction of hot air, and also openings for cleaning the space between the double walls. The drying-boxes are covered on the top with brass-wire gauze forming a grating, on which cloth is fixed by means of wooden strips and bolts. The charge of powder is placed on to the cloth through the hood, turned over by rakes, and taken out from the discharging-holes.

The heating arrangement is shown in Fig. 108. It consists of a sheet-iron box open at the top, in which a heating-coil of 10 turns made of 2-inch iron pipes is fixed. A number of such boxes are connected by means of a square inlet-pipe for the steam, and by a discharge-pipe for the condensed water. The whole is encased with brickwork with a detachable front, through which the discharge-pipe of the fan enters. At the bottom of the sheet-iron box a hot-air exit-pipe to the drying-boxes is fixed. The cold air rising from the bottom of the brick-casing is partly heated by the outer walls of the sheet-iron box, and after being further heated by the coil inside the box, passes out at the bottom of the heating-box into the drying-box. For each square foot of the drying-box 5 square feet of heating surface are provided in the apparatus. The temperature of the air is 133° F., and the fan makes 700 revolutions per minute.

The following table given by Désortiaux shows the result of drying with this apparatus :—

KIND OF POWDER.	DRYING PER SQUARE METRE OF SURFACE OF TABLE.			QUANTITY OF POWDER DRIED PER SQUARE METRE OF SURFACE OF TABLE.	
	Charge. Kilo-grammes.	Height of Layer.	Duration of drying hours.	In 1 hour. Kilo-grammes.	In 14 hours. Kilogrammes.
Ordinary mining powder ...	200	0.210 to 0.230	7 to 8	25	350
Ordinary military powder ...	40 to 45	0.050 ,, 0.060	3 ,, 4	10 to 15	140 to 210
Sporting powder { extra fine	30 ,, 45	0.035 ,, 0.050	9 ,, 13	9 ,, 13	126 ,, 182
superfine					
powder { fine ...	25	0.030	7	7	98

Another method of drying powder is by dried cold air. This can be done by passing the current of air, by means of a fan or

chimney, through one or more rooms, in which freshly-burned lime or calcium chloride are piled up, before it enters the drying-room. It is, however, better to do it in a special drying apparatus. Drying air over fresh-burned lime produces much heat and steam, and the simple piling up of calcium chloride produces in time a solution of calcium chloride on the floor.

The apparatus shown in Fig. 109 has been used with good results by the author for drying air. It consists of a wooden box (A) running along the whole length of the drying-house in the open air. About half-way up the box longitudinal strips (b) are fixed, on which a frame (c) covered with galvanized wire gauze rests, and on to which dry calcium chloride is placed in large lumps. The bottom part and the floor of the box are lined with sheet-zinc. The bottom is slightly inclined, and at its deepest part there is a discharge-pipe (D) for removing the solution of calcium chloride



FIG. 109.—One-50th full size.

which is formed. The air enters from the fan (E) through one or more inlets below the frame, passes through the layer of calcium chloride along the whole length, and is carried away at the upper part by means of branch pipes into the drying-boxes. The calcium chloride solution is collected, and after evaporation in coppers over a fire, and then re-fusing it, can be used again for filling the box.

Another apparatus for the production of dry air, of which the author has also personal experience, is illustrated in Fig. 110. It answers well in cases where rapid drying is required, and where it does not matter much whether the powder becomes porous or not—for instance, with powder containing sodium nitrate. The apparatus consists of a fan (A), and an iron or brick casing (B), in which are fixed several of Körting's gilled pipes (C). Air is blown through this casing, and afterwards through an absorbing vessel (D) made of sheet-lead, and the neutralizing vessel (E) made



of sheet-iron. The air inlet-pipe of the absorbing vessel reaches down nearly to the bottom, whilst the outlet-pipe leaves flush with the cover. The absorbing vessel is about half filled with concentrated sulphuric acid, and when the sulphuric acid becomes too diluted on account of the absorption of water from the air, it is drawn off through a tap at the bottom and re-concentrated. The neutralizing vessel is filled with unslacked lime in order to neutralize any traces of sulphuric acid or sulphuric vapours which are always present in the current of air. Temperatures up to 212° F. can be obtained by this apparatus by using a sufficient number of gilled-pipes. If a less rapid drying is desired, the heating apparatus (B) can be left out, and then only cold dry air will be produced.

Experiments made at Bouchet with prismatic powder containing about 5 per cent. of moisture showed that on drying

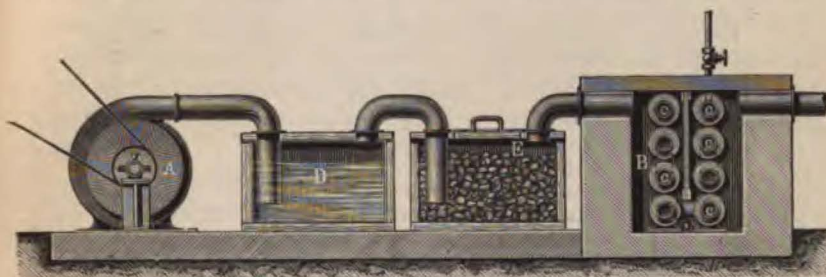

FIG. 110.—One-36th full size.

it with warm air, or in the open air, it became covered with an efflorescence of nitrate, the formation of which could only be prevented by using cold dry air.

Laville some time ago proposed drying powder at ordinary temperatures in vacuo. Recently it was repeatedly proposed to make drying-boxes in which the powder was heated by radiating heat whilst a vacuum was maintained in them. It is theoretically quite correct that a much quicker drying can be effected in a vacuum, and experiments have also shown that repeated drying and moistening of powder does not materially alter its density. In practice, this behaviour of powder is of no great importance; moreover, it is difficult to treat large quantities in a vacuum, whilst on account of the large quantity of power consumed in producing the vacuum, the method is very uneconomical.

In whatever manner drying is done, it is necessary that a

continuous changing of the air should take place. It is theoretically quite possible to dry by cold, undried air, but the drying process would be a very slow one.

Drying with heated air in boxes depends on the property possessed by air of taking up larger and larger quantities of moisture as its temperature is raised. For instance, one cubic foot of air saturated with moisture at say 60° F. contains a smaller weight of vapour than one cubic foot, also saturated, at 90° F.

The amount of moisture required to saturate air at different temperatures is given in the following table:—

TEMPERATURE.		GRAMMES OF WATER IN A CUBIC METRE.	GRAINS OF WATER IN A CUBIC FOOT.
Degrees C.	Degrees F.		
- 10	14	2·317	1·012
- 5	23	3·336	1·334
0	32	4·793	2·095
+ 5	41	6·722	2·938
10	50	9·318	4·072
15	59	12·715	5·557
20	68	17·150	7·495
25	77	22·851	9·898
30	86	30·116	13·161
35	95	39·274	19·637
40	104	50·714	22·162
45	113	64·861	28·444
50	122	82·217	35·929
55	131	103·330	45·155
60	140	128·829	51·532
65	149	159·397	69·657
70	158	195·800	85·290
75	167	238·854	168·859
80	176	289·470	126·498
85	185	348·621	152·347
90	194	417·362	182·387
95	203	496·824	217·113
100	212	588·208	257·047

The time of drying depends both on the construction of the drying apparatus, and also upon the thickness of the layer of powder, the temperature of the current of air, and the size of the powder grains.

Drying in boxes with simple cloth-covered frames takes some time, and is a little inconvenient, but it has the advantage that the powder can be spread in a thin layer on to the cloth, which, whilst it does not allow the powder to fall through, lets the air pass up through the powder.

The disadvantage of drying on open frames is that those trays which are nearest to the steam-pipes are dried the **quickest**.



Those placed higher are not only subjected to comparatively cool air, but also to air which already carries moisture. In extreme cases it may even happen that instead of the powder being dried, its moisture is increased. The same sort of thing takes place if the layer of powder on the tray is too thick, when the upper layers of the powder will appear more moist on account of the vapour issuing from the lower part.

With a not too finely grained powder, a height of  $2\frac{1}{2}$  to 3 inches is the maximum thickness for a layer of powder undergoing drying. Very finely granulated powders must be in still thinner layers, because otherwise the air pressure set up by the fan would have to be excessively large in order to overcome the resistance of the powder, and in this case it is quite possible for the lower part to become inconveniently hot.

Very coarse-grained or highly-compressed powder will necessarily take a longer time in drying than porous middle-sized powders. Cubical and prismatic powders must be dried quite gradually, otherwise they crack on account of the rapid driving off of the moisture, and are coated outside with an efflorescence formed by the partial solution of saltpetre in the escaping steam.

Of the various methods of drying, that by blowing in warm air is the most advantageous, although drying in the open air, or in large drying-rooms, has the advantage that the operation is more gradual. Yet the advantage of a continuous renewal of air of uniform temperature and the perfect control of the drying process are of such great value, that the little extra cost for producing the current of air is hardly of importance.

### (c) DUSTING AND FINAL GLAZING.

During the operation of drying a quantity of dust, depending on the shape and size of the powder, is formed, and has to be removed by a special operation. Advantage is taken of this opportunity to give the powder a more finished surface.

Formerly dusting was done in linen bags, 10 of which were fitted in a room boarded up air-tight. The bags were tied, at their open ends, to copper rings fixed on the wall. Close to the rings were oval openings through the wall, through which the bags were charged with from 11 to  $13\frac{1}{2}$  lbs. of powder. The open ends were then tied up and the oval openings closed with a cover. On the other end of the bag leather loops were sewn on,

through which a rope connected to a lever arrangement above the ceiling of the room was put; by this arrangement the bags were moved up and down.

A little later this dusting machine was altered, and at Dresden and Spandau it was arranged as follows:—The dusting-house was divided into three compartments. In the first one, the powder was put into the dusting-bags, and also discharged after dusting; in the second one was the motor; and in the third one two horizontal wooden shafts (Fig. 111), each about 23 feet long, with 15 wooden dusting-arms, about 6 feet long, 4 inches wide, and  $\frac{3}{4}$  inch thick, fitted through the shaft. These dusting-arms were arranged spirally, and made two turns round the shaft. Each dusting-arm carried on the front and back two

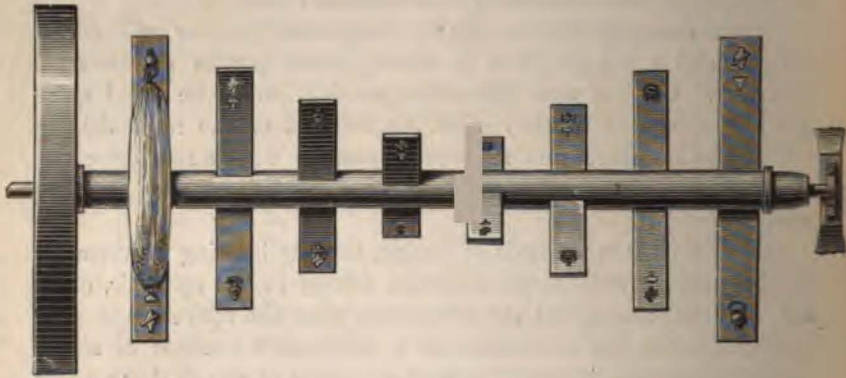

FIG. 111.

loops, to which a dusting-bag was attached by copper hooks on each side. The dusting-bags were 5 feet 2 inches long,  $10\frac{1}{2}$  inches wide, and held 15·4 lbs. of powder, which did not, however, fill up the whole bag, so that, as the shaft turned, the powder rolled up and down. The apparatus was then kept rotating at 12 to 14 revolutions per minute for from an hour and a half to two hours. The dust passed through the pores of the bag, whilst the grains, by rubbing against each other and against the bag whilst rolling to and fro, obtained a high gloss on their surface. The grains falling through the bag were again dusted in a very fine bag. The dust consisted chiefly of charcoal. In 100 parts of it 74 parts of charcoal,  $14\frac{1}{2}$  parts of sulphur, and 11·6 parts of saltpetre have been found. The dust was collected and lixiviated to recover the saltpetre.

Now-a-days, dusting is generally done in cylindrical sieves, such

as the one illustrated in Fig. 112, which is made by J. and E. Hall, of Dartford. They consist of a horizontal reel about 8 feet long and 2 feet 6 inches in diameter, enclosed in a box, and covered with fine brass-wire gauze, or with silk gauze as used in flour-dressing. Each cylinder is charged with about 3 cwt. of powder, and makes 45 revolutions per minute, the operation lasting 3 hours. Sometimes a little black-lead is added to increase the gloss of the powder. This has, at the same time, the advantage that the density of the surface is increased by the finely-divided black-

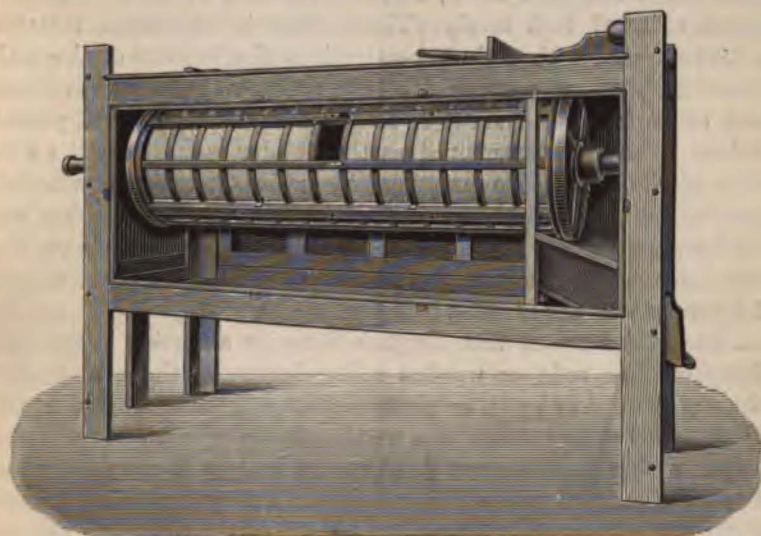

FIG. 112.

lead, and in consequence the powder is rendered less hygroscopic. Through the continuous friction the temperature of the powder increases during dusting, and special attention is therefore to be given to regulating it by the speed of the reel.

Dusting-reels can also be used for mixing together or "blending" various powders, and great attention is given to producing, in this manner, large batches of as uniform a quality as possible. This can be done still more effectively if the various powders run into the reel by means of a funnel.

## (f) SORTING.

The shape and size of the grains are altered again by the rounding, drying, and dusting. It is therefore necessary to once more sort it. In Germany they use for that purpose a sifting-reel, like the so-called "trieurs." Such a reel is a long slightly-inclined cylinder, enclosed in a dust-box. Its frame is made of wooden strips covered over for the first two feet with wire gauze of 0.014 inch mesh, and for the rest of its length with gauze of 0.047 inch mesh. The powder is introduced through a funnel fitted with a shutter-valve into the interior of the reel. The dust-box has a pyramidal bottom for each of the two divisions, and on to it a cloth shoot is fixed leading into a barrel placed below. The dust is removed as the powder passes over the first part of the reel. The proper sized grains, *i.e.* the serviceable powder, fall through the rest of the reel, and any grains that are too large pass over the sieve and fall through an opening on the circumference, or through the end of the reel. The reel makes 12 revolutions per minute.

In some German and English factories a sorting apparatus, hung on four rods, or wooden spring-beams, to the ceiling, and shaken by hand or by an eccentric at 120 strokes per minute, is still used. This sieve consists of a wooden frame with two superposed sieves, with a flexible shoot fixed on the bottom to carry away the fine powder. All grains larger than the size required for cannon-powder remain on the upper sieve; those of the right size remain on the second sieve; and the fine powder falls through the shoot. Sometimes the mesh of the sieve is so arranged that the upper sieve retains the powder that is too coarse, the second one rifle powder, whilst the shoot carries away dust. In Denmark an inclined wire-covered reel is used, with a fan, which carries away the dust from the powder to special dust-catchers. In France no sorting takes place, the elimination of the fine powder being done before the dusting process. The powder, even though the sorting be done with the greatest regularity and care, will always contain a certain percentage of grains above and below the size aimed at. As this percentage may vary considerably in the course of the different operations, the powder undergoes a subsequent process called "blending," the object of which is to obtain a product of uniform quality.

## (g) BLENDING.

As previously mentioned, blending is done in Great Britain in the dusting-reels, and sometimes also in a funnel with four inlets.

At Spandau the blending apparatus is arranged as follows:—A stout round wooden shaft is suspended vertically from the ceiling of the room, and on its lower end, about 4 feet from the floor, it carries a wooden platform; six copper funnels are let into this in an inclined position. The outlets of these all lead into a tube forming a prolongation of the shaft. Each of the funnels at Spandau holds 220, and at Dresden 440 lbs. of powder. On the lower end of the main pipe a short leather hose is fixed, the end of which can be lifted by a cord so as to form a kink in it and stop the powder from running out.

In blending, a special and a general blending are distinguished. In the special blending at Spandau, two barrels of the powder to be blended are put into each funnel, the leather hose being then closed. When all funnels are filled, the leather hose, under which a barrel is placed, is opened. Twelve such barrels make a special blending, and in Dresden twenty-four, since the funnels hold double the quantity of those at Spandau. When twelve and six preliminary blendings have been made in these places respectively in this manner, a final blending is done by taking from each preliminary blending one or two barrels respectively, and blending them in a similar manner until all preliminary blendings have been mixed together.

The blending apparatus used in Switzerland consists of a square box with pyramidal bottom, which rests on four feet. A sheet-metal pipe, having holes between  $\frac{1}{2}$  and  $\frac{2}{3}$  inch width, and between  $\frac{2}{3}$  and  $\frac{1}{2}$  inch apart, is fixed on to the opening of the funnel. Between the pipe and the discharge opening of the funnel a damper is placed. The box holds between 12 and 14 cwts., and about 1 cwt. of each of the powders to be mixed is run in alternately. As soon as the apparatus is filled the damper is drawn, the tube discharges, and the powder now issues from all sides through the perforated pipe, and is mixed on falling into the barrel placed below. For large-grained powder a framework made of wooden staves is used instead of a perforated cylinder.

In the French powder factory at Sévran-Livry another kind of mixing apparatus is used. It consists of a wooden frame about 6 feet high, on which eight wooden trays are arranged, in two

parallel rows of four each. Each of these frames has an opening in the centre, from which more or less powder can run out through a shutter-valve. The powder falls on to an endless cloth band moving under each frame. These discharge on to another endless band moving at right angles between them. The shaft of one of the rolls carrying the central endless cloth is fitted with a handle and two worms geared into wheels. The latter give to the first endless bands a velocity ten times that of the central band. At the end of the central band is a small trolley carrying two barrels, into one of which the band discharges the blended powder. As soon as it is full the trolley is moved on one side, so that an empty barrel comes under the endless band. The full barrel is then emptied and replaced, and so on.

### 3. COMPRESSED POWDER.

General Rodman, of the United States army, when experimenting with 15-inch and 20-inch cast-iron guns, found that he could considerably reduce the initial pressure in the gun by using discs, perforated with a number of holes, of compressed powder of a diameter equal to the calibre of the gun and between 1 inch and 2 inches thick. In a work published by him in 1861, he showed that at the beginning of the combustion such discs presented a minimum of free surface, which, as the powder burnt, continually increased through the constant enlargement of the holes, and on account of this constant increase of the area of burning surface the rate of production of the gases also constantly increased. This discovery of Rodman's was first practically used in the American civil war, during which the consumption of powder increased in such an extraordinary manner that the manufactories could not meet the requirements of the artillery, and making cartridges direct from the cake by means of pressing was tried. The cartridges so made did not answer the expectations, as interstices were wanting; thus the powder only burned in layers, and the charge was blown out of the gun partially unconsumed. To overcome this defect the cartridges were perforated, both longitudinally and transversely, when good results were obtained, especially with guns of larger calibre.

About the same time granulated powder compressed into blocks was tried. It was a revival of a suggestion made by Paolo di San Roberto in 1852, whose idea was to utilize the low melting-point (230° F.) of sulphur to form the powder into blocks. These

blocks were made by putting powder into sheet-metal vessels surrounded by a jacket filled with boiling water; the sulphur was softened, and the powder grains adhered to each other without losing their shape. The heated powder was then put into cylindrical moulds and pressed. In the resulting cartridges the grains were still perfectly recognizable, but adhered firmly to each other. They were hard as stone, black, and shining, and could be thrown to the ground without breaking. They gave very uniform results, both in guns and rifles, and the residue in the barrel was slight. This method of making compressed cartridges by softening the sulphur was soon given up, on account of its great inconvenience, but in nearly all countries attempts were made to utilize a binding agent, such as solutions of gum, sugar, or collodion, instead of heat. Brown patented a mixture made in the following way:—One part of gum arabic was to be dissolved in two parts of cold water, and a quarter part of saltpetre in  $1\frac{1}{4}$  parts of water. Alcohol was to be added to both mixtures, and the whole stirred until an opaque liquid was formed. The powder grains were to be moistened with this solution and compressed in a mould.

During the American civil war, a Russian military commission visited the United States, and from what they learned of the behaviour of compressed powder, the manufacture of prismatic powder on a large scale was introduced by General Doremus. According to Doremus' original method, the granulated powder was made into cartridges of cylindrical shape by a light pressure, so as not to destroy the granular texture. In order to make the combustion keep pace with the increased surface, he made different sections of the same cartridges of varying densities. This was done by making the first part of the cartridge at a high pressure, and then making two more layers on to the same cartridge at lower pressures.

These cartridges were also tried for war purposes, and abandoned by all countries except France, which alone still uses compressed cartridges, though only in mitrailleuses. The mitrailleuse cartridge consists of a cardboard and galvanized iron case containing twenty-five metal cartridges, arranged in such a way that they place themselves automatically in front of the twenty-five barrels of the mitrailleuse. Each cartridge contains six small discs of compressed powder about  $\frac{3}{8}$  inch thick, and  $32\frac{1}{2}$  grains in weight. Over the powder is a  $\frac{1}{2}$  inch grease wad, and over this the projectile. On the other hand, compressed cartridges are used extensively for mining purposes in Great Britain, Austria, and Switzerland.



In 1868, when Fenian disturbances were feared, the buck-shot cartridge, invented by Colonel Boxer, was adopted for the arms used by the Royal Irish Constabulary. Its charge consisted of fine-grained powder compressed into a cylinder, with an indentation on the top and bottom, and it was loaded with sixteen deer shots, the space between which was filled up with plaster of Paris.

The manufacture of compressed cartridges for mining purposes is almost entirely carried out by means of mechanical presses, but in large factories hydraulic presses, similar to those used for prismatic powder, are employed, which make one hundred cartridges at the same time. Figs. 113 and 114 show a cartridge press made by Charles Zimmermann, of Ehrenfeld, near Cologne, for the Swiss gunpowder factories.

The fly-wheels ( $a_1$ ), with handle ( $a_2$ ), are fixed on the same shaft as the pulley ( $a_3$ ). This shaft drives the eccentrics ( $a_4$ ) through a double pair of cog-wheels. The eccentric lifts the guide-bar ( $b$ ), and with it the piston ( $c$ ). A hopper ( $E$ ) filled with gunpowder is pushed on to or from the cylindrical mould ( $f$ ), as required, by means of the tappet-driven lever motion ( $d$ ). As the guide-bar ( $b$ ) goes down, the hopper ( $E$ ) moves back, and the piston ( $c$ ) compresses the powder in the mould, whilst the lower piston rests firmly on the cross-bar ( $i_3$ ), which is carried by means of the adjustable nuts ( $i_2$ ) on the two side bolts. As the eccentric continues to revolve, the piston ( $c$ ) is lifted, when the cross-bar ( $H$ ) carried by the rods ( $G$ ) catches the lower piston ( $i$ ) and lifts the cartridge out of the mould ( $f$ ), keeps it suspended for some time, during which time they are removed, and then lets the piston ( $i$ ) descend again. For this purpose the cross-bar ( $H$ ) is provided with a slot. The tappet ( $k$ ) puts  $H$  in position for lifting the piston ( $i$ ), whilst the upper one ( $l$ ) throws it on one side, and allows the piston to fall. The same movements of the hopper, piston, etc., are then repeated. With the press here illustrated, a central hole is made through the cartridge by means of the pin ( $k_1$ ) carried on the cross-bar ( $m$ ).

Another press for the same purpose is illustrated in Fig. 115. In this form a circular table ( $A$ ) containing six holes, serving as moulds, is made to rotate. A cross-head ( $B$ ) carries two carriages ( $C$  and  $C_1$ ), to which are attached the pistons ( $D$ ). The carriages move in V grooves, and are pushed up and down by means of rolls and lever arms ( $E$ ), actuated by eccentrics. One of these pistons is longer than the other; the shorter one compresses the cartridge, and the longer one pushes it out of the mould. Below the table is an iron plate ( $F$ ) with an opening opposite to the pressing-out

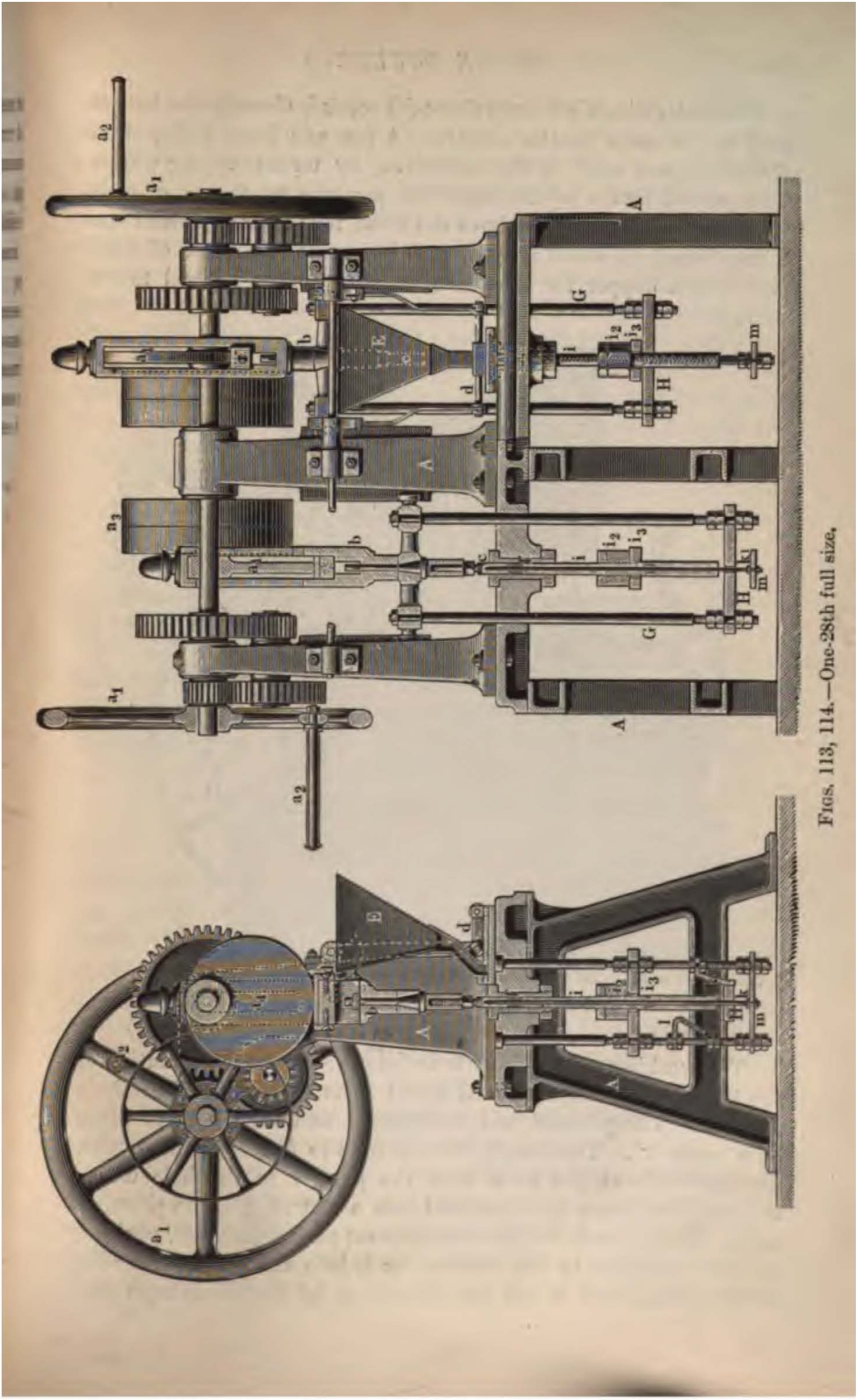

Figs. 113, 114.—One-28th full size.

piston, under which is a steep shoot (g) passing through the bottom part of the press to the outside. A fast and loose pulley drive the shaft, and with it the eccentrics, by means of cog-wheels. Two armed levers (s) transmit the pressure by means of cams to the piston carriages. Above the front hole is fixed a short iron filling-funnel (i), which is connected by means of a piece of hose-pipe with a hopper for the powder. The hopper is fixed to the ceiling.

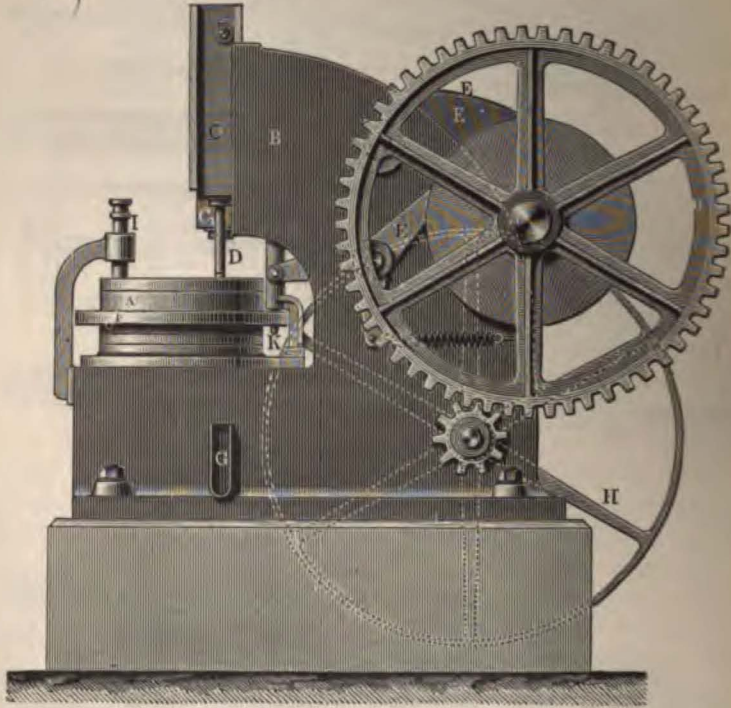

FIG. 115.—One-20th full size.

The working of the press is as follows:—At each revolution of the pulley the table is moved round so as to bring a fresh hole under the filling-funnel and the pistons, and then held in place by a catch (k). The empty hole under the funnel is filled with powder, while at the same time the powder in the hole under the pressing piston is compressed into a cartridge. The pressing piston is then lifted, and the pressing-out piston descends, pushing out the cartridge in the hole under it into the shoot. As soon as the pressing-out piston has risen clear of the revolving table,

the latter advances again by one hole, and the same action is repeated.

Presses constructed in a similar way, but with filling hoppers which advance automatically, have been built in England.

It is a matter of history that in the American civil war in 1860 the Confederates protected their war-vessels with iron plates in order to avoid the deadly effect of projectiles from the naval guns. This had the natural effect of causing the projectiles and the calibre of the guns to be increased in order to penetrate the armour; and since that time the competition between armour plates and guns has been continued, and has led finally to the use of armour plates of enormous dimensions and of 100-ton guns.

The ordinary powder cannot be used for the increased charges

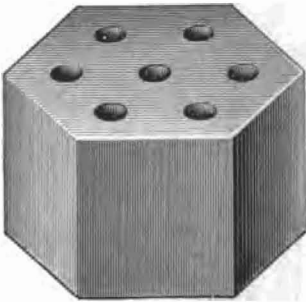

FIG. 116.

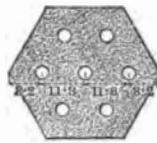

FIG. 117.

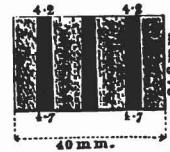

FIG. 118.

demanding by larger guns, since with them the suddenly-developed gas pressure is too high, and would destroy the gun. The rate of combustion of the charge had therefore to be slackened. This led to the manufacture of large grains, and later on to the prismatic powder. The idea upon which the use of compressed powder is based is the following:—If a fine-grain powder is used for large charges, the greater part of the charge is burned at the moment of ignition on account of its very large surface. Therefore, a considerable maximum pressure will result, leading to very violent effects, whilst the average force developed will be small in comparison with the first part. The opposite takes place if so-called “progressive powder” be used, as is the case with all compressed powders. At the commencement of combustion they only present a small surface and develop no more gases than are required to overcome the inertia of the projectile, but their

quantity increases constantly during combustion, thus causing a gradually increasing pressure. As has been said above, every compressed powder which burns in layers will give progressive action, and the rate of combustion can also be regulated by various means. The following kinds of compressed powders are in use:—

The prismatic powder, Figs. 116 to 118, which is compressed into regular hexagonal prisms, pierced as a rule with one or seven holes. The object of the hexagonal form is to facilitate the

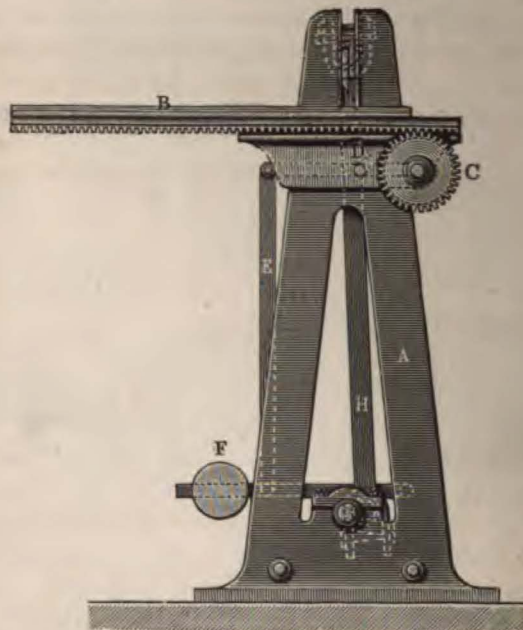

FIG. 119.—One-15th full size.

arrangement of the prisms side by side and the introduction of the powder into projectiles as bursting charges. The other kinds are pebble and cylindrical powders, which will be referred to later on.

With these powders the projectile at the beginning of its movement has only a low velocity imparted to it on account of the small quantity of gases developed at the start. The projectile consequently takes the rifling properly and obtains a regular motion, which is of importance, as a uniform direction of flight and a uniform velocity depend upon the uniform movement of the projectile in the barrel.



The first compressed powder, properly speaking, was the Mammoth powder of General Rodman, some of which had a diameter of 3 inches. Lord Armstrong used large-grained powder ("R. L. G.") for his guns in 1860. In order to slacken the rate of combustion the grains were polished with black-lead in wooden drums. The size of the grains with the "R. L. G." No. 2 powder now in use is such that they remain on sieves of 6 meshes per square inch and pass through one of 3 meshes per square inch.

Some time later pebble powder was made by compressing the

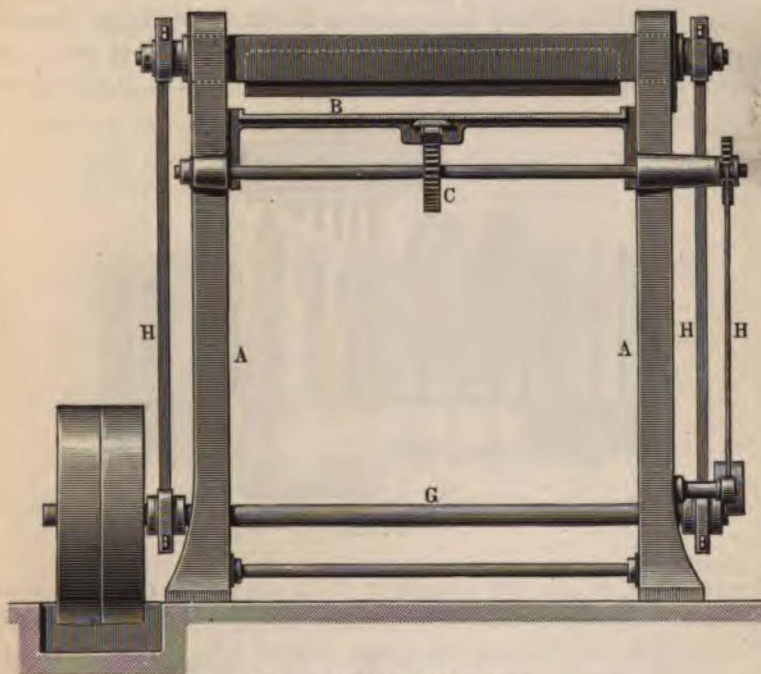

FIG. 120.—One-15th full size.

cake to the density of 1.8, and breaking it in pieces, which were sorted through sieves of between  $\frac{1}{2}$  inch and 1 inch mesh. Later on cubical powder was made by means of a cutting machine, a process which is still used in some factories. A machine for this purpose, made by the Grusonwerk, is shown in Figs. 119 and 120.

It consists of a strong cast-iron frame (A) with a movable table (B), on the lower surface of which, in the centre, is a rack which is geared into a cog-wheel (C) fixed to a shaft. At the end of the latter is a ratchet-wheel and pawl actuated by a lever (E) with

a counter-weight (F). The lever is moved by an eccentric fixed on a shaft with pulleys fitted on the lower part of the frame. The main shaft (G) is also on the lower part of the frame, and has an eccentric at each end, which is connected by means of rods (H) with a brass knife (I) guided at each end in slots on the upper part of the side frames. At each revolution of the shaft the knife is lifted, the table advanced one tooth, the knife brought down, and a strip of the powder cut off. After the whole cake on the table has been cut into strips they are placed on it again in a longitudinal direction and cut into cubes.

At Waltham Abbey an apparatus invented by Major Morgan was used for cutting cubical powder, the principle of which is shown in Fig. 121. It consists essentially of two pairs of phosphor-

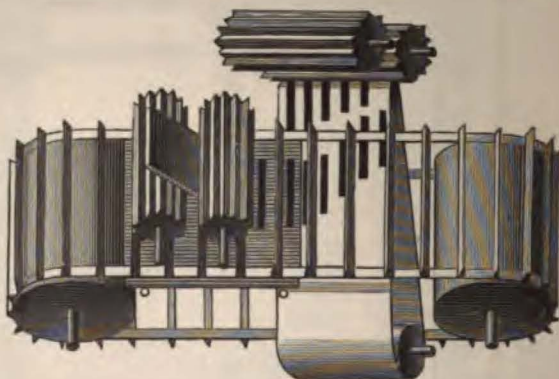

FIG. 121.

bronze rolls, which are placed at right angles to each other at different heights, on the circumference of which knives are fixed. The powder cake enters the upper pair of rolls, and is there cut into longitudinal strips, and pushed along a table by a conveyor on to an endless band. This moves at right angles to the conveyor, and carries the longitudinal strips to the lower pair of rolls, which break them into cubes. If a fixed board under the lattice band were used, the second longitudinal strip would fall on to the first, and so on, and the consequence would be an accumulation of strips on the lower endless band. In order to avoid this, the board is arranged to move backwards and forwards between certain limits. The mechanism to effect this is illustrated in Fig. 122. As will be seen, the bottom part of the board has a fixed slotted bar. An endless chain, moving over two correspondingly



shaped rolls, has a pin on one of its links, which engages in the slotted bar. It will be readily seen that as the chain continuously travels the board first obtains a movement to the left, and as soon as the pin has reached the roll it is moved to the right. The consequence is that the strips on the endless band lie side by side instead of one above the other.

One hundred and sixty grains of cubical powder go to a pound. They measure between  $\frac{1}{2}$  inch and  $\frac{5}{8}$  inch on each side, and have a density of about 1.800. Larger cubes are used for the largest guns.

In whatever manner the cubical powder is made, it is always rounded after cutting, so that when it is stored or carried, no dust or waste will be produced. For this purpose the powder is rotated in a cylindrical reel, by means of which the sharp corners are rubbed off, and at the same time the fine stuff and dust produced are removed. After drying, the powder is again

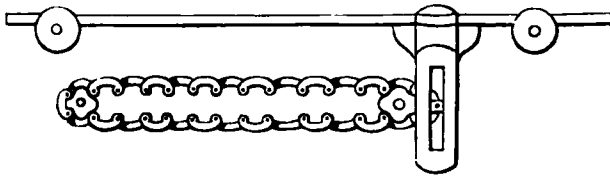

FIG. 122.

treated in a reel with black-lead. Similar powders are made in almost all Government factories.

In 1860 it was again Rodman who suggested the compression of powder into plates by hydraulic pressure, in such a way that when the plates were laid one on top of the other they formed a cylindrical charge. Each of these plates was perforated, and in this way he made charges up to 75 lbs. weight; but this was attended by considerable difficulties, particularly in the pressing out of the moulds of such large and thick discs.

In 1872 Professor Wyschnegradski invented a press for the manufacture of prismatic powder, which is still used in all Government factories. It is the so-called cam-press, and is illustrated in Fig. 123. It consists of three cross-heads, an upper, a central, and a lower one. The upper and lower cross-heads are connected with each other by means of bars, and they move an upper and lower traverse by means of eccentrics and cog-wheels in such a way that the two traverses approach each other up to a certain point and

then move upwards. Each traverse has six pistons perforated longitudinally by seven holes. The steel moulds for the compression of the powder are placed in the centre cross-head. On the lower traverse are fixed seven steel needles, which are slightly tapered, and about 0.2 inch in diameter. They pass through the perforations of the lower pistons up to the surface of the centre cross-head. The powder is introduced from a brass box which

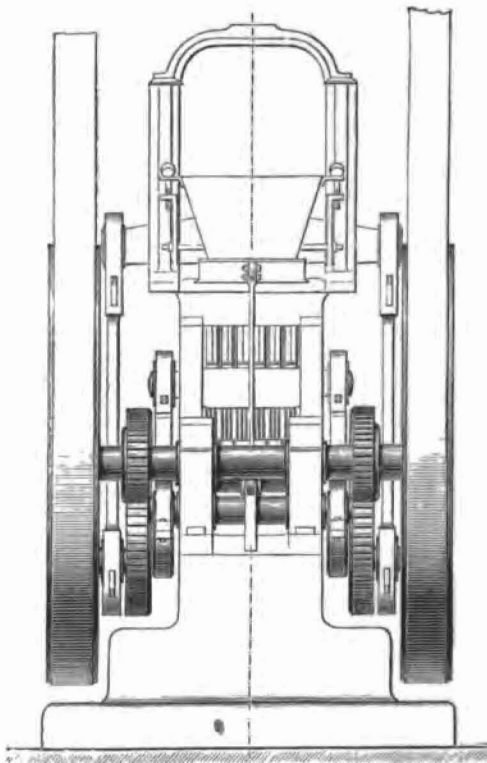

FIG. 123.

moves to and fro on the centre cross-head, and has seven tubes for measuring the powder. The charger moves with the machine, and as soon as it is brought over the moulds, the powder from the measures falls into them. The charger then moves away, the two pistons approach each other, and the eccentrics are so arranged that after the upper pistons have reached their lowest positions, the bottom piston continues to move upwards. The upper traverse is then lifted quickly by means of a large eccentric, the lower

pistons push out the compressed prisms, and the charger coming forward, pushes them over an incline towards the attendant.

A similar press built by the Grusonwerk of Buckau is illustrated in Fig. 124, the general arrangement of which can be well seen from the drawing.

In Great Britain and France prismatic powders are now almost

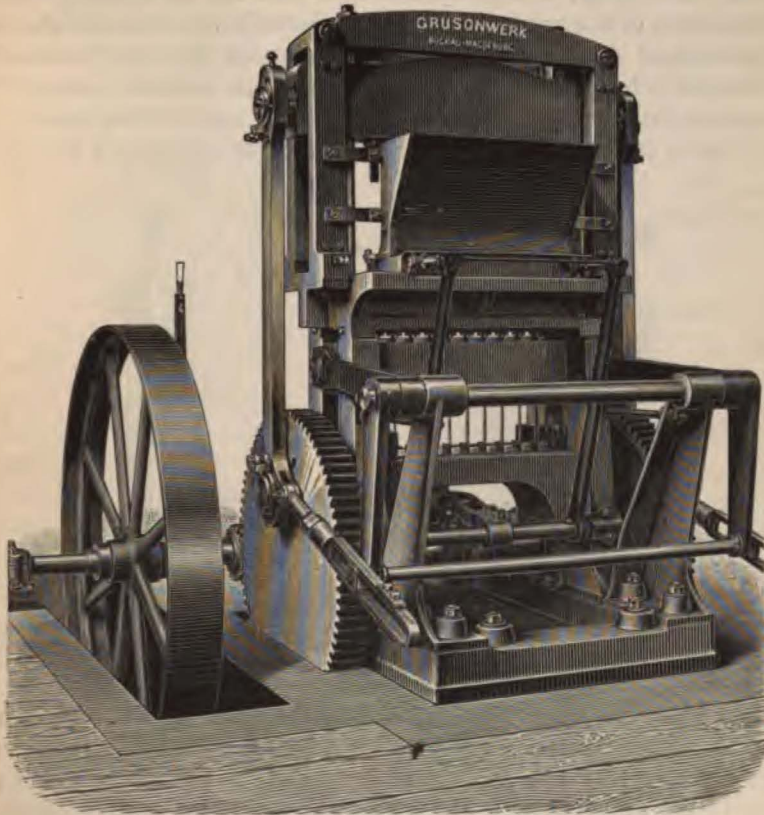

FIG. 124.

exclusively made by hydraulic pressure. Before considering the various systems of presses, it is advisable to make a few general remarks on hydraulic presses.

On the 30th of April, 1795, Joseph Bramah took out a patent in England for a hydraulic press. It was based upon the principle that if pressure is exerted upon one part of a fluid enclosed in a vessel, it will be uniformly transmitted in all directions, so that

every part of the walls of the vessel is subjected to the same pressure as that exerted on the particular part. If, now, in such a vessel a tightly-fitting ram be placed, each part of the outer surface of the ram that is inside the vessel will be subjected to the same pressure.

Supposing that in Fig. 125 A be such a vessel, B such a piston, and C the piston of a pump, and also that the force acting upon the piston of the pump be of such magnitude that it will exert a pressure of 4000 lbs. on it; further suppose that the piston of the pump have a diameter of 3 inches (or a sectional area of 7 square inches in round figures), and the ram in the vessel a diameter of 24 inches (or a sectional area of 452 square inches),

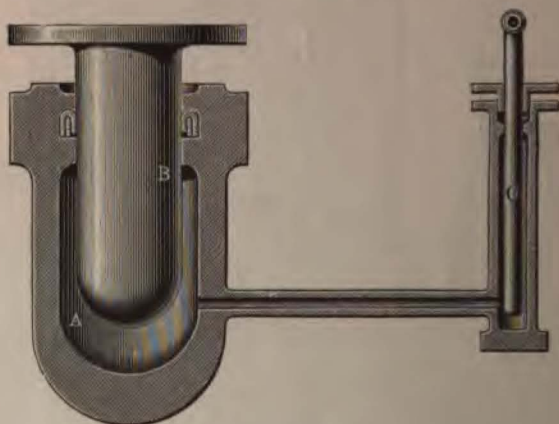

FIG. 125.

then when the pump forces water into the vessel each square inch of the water surface in the pump will be submitted to a pressure of  $\frac{4000}{7}$  or 556 lbs. per square inch, and this pressure will be uniformly transmitted to the surface of the water, and in consequence also on to the lower surface of the ram (B). The latter, therefore, will be subjected to a pressure of  $452 \times 556 = 251,312$  lbs., and at the same time will be lifted by the water forced in by the pump; it will therefore be able to transmit the pressure to other objects. If the piston of the pump have a diameter of 2 inches only—*i.e.* an area of 3.14 inches—then each square inch of water surface will have a pressure of 1274 lbs. on it. The pressure exerted on the piston in the vessel will then be  $452 \times 1274 = 575,848$  lbs.

The total pressure exerted on to the ram of the press is therefore inversely proportional to the square of its diameter. It does not make any difference whether the piston of the pump or the ram of the press be flat or rounded or quite round, since the pressure always corresponds to the area, which depends upon the diameter of the piston and not upon the surface of the semi-circular end.

The amount the ram of a hydraulic press is lifted depends upon the quantity of water introduced. If, in our example, we suppose that the piston of the pump has a stroke of 15 inches and makes 60 strokes per minute, then  $15 \times 7 = 105$  cubic inches per second will be forced into the press, and the ram will be lifted  $\frac{105}{452} = 0.232$  inch per second. With a pump piston of 2 inches diameter, and the same number and length of strokes, only  $15 \times 3.14 = 47$  cubic inches of water will be pumped in, and the ram will only rise  $\frac{47}{452} = 0.104$  inch per second. The total pressure exerted by the piston can be used at its upper surface in any desired manner, whatever its form or however large it be; for instance, a plate may be put on the top. If, on the other hand, a press piston for cartridges were put on the top of the ram of the press, then the total pressure acting upon the ram would also act upon the cartridge piston. Supposing that the cartridge piston have a circular section of 6 inches diameter, corresponding to an area of 28.27 square inches, then this piston will, by using a 3-inch pump, be subjected to a pressure of  $\frac{2.5}{1.5} \cdot \frac{3}{2} 1^2 = 8890$  lbs. per square inch, and by using a 2-inch pump to a pressure of  $\frac{5}{1.5} \cdot \frac{3}{2} 1^2 = 20,370$  lbs. per square inch. If, instead of the one large piston, several small ones be placed upon the ram, then the pressure exerted in this case depends on the sum of their areas.

If a hydraulic pump be connected with the ram of a press used for compressing objects, the pressure will be exerted in jerks, because the working of a pump is not smooth. This causes unequal pressing, and sometimes more power is required. To avoid this, appliances called "accumulators" are used. They are really nothing but a hydraulic press, because the pressure exerted upon a piston is used to lift a certain calculated weight, which in its turn exerts the pressure upon the press by means of a branch-pipe.

There are two kinds of accumulators—those with a fixed cylinder where the ram is lifted, and those where the ram is fixed and the cylinder lifted. In Fig. 126 an accumulator made by Easton, Anderson, and Goolden, Limited, of Erith, is illustrated. The fixed



part of accumulators is firmly bolted to the ground by means of large bed-plates and foundation-bolts, and the movable part has a cross-head on to which weighting-plates are laid or suspended by means of bars. In order to facilitate putting on and taking off these weights, they have, as a rule, an opening cast in them from the centre to circumference, so that they can be pushed on to the ram instead of being slipped over it; in this case the openings are,

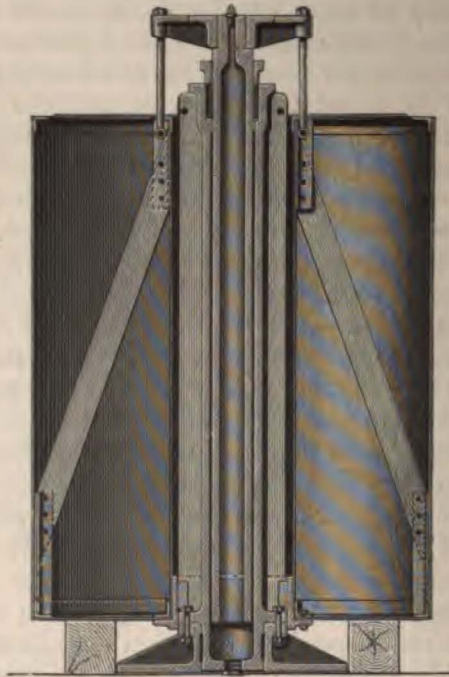

FIG. 126.—One-32nd full size.

as a rule, placed at an angle of  $90^\circ$  from each other to prevent the plates falling off.

It is cheaper and more advantageous to use a wrought-iron shell, as in Fig. 126, instead of weight-plates, and to fill it with scrap-iron or with water.

Supposing that a pump with a piston of 3 inches diameter, as mentioned before, acts upon an accumulator, the piston of which is 12 inches in diameter, and consequently has an area of 113 square inches. If this piston be weighted with 50,000 lbs., and its own weight be 2000 lbs., then each square inch of the water surface in

the accumulator will be subjected to a pressure of 460 lbs. If now from another part of the cylinder a discharge-pipe be led to the ram of the press before mentioned, then each square inch of the ram will have the same pressure, and the total pressure in the press will be  $452 \times 460 = 207,920$  lbs.; but if the ram of the accumulator have a diameter of 2 inches only, or 7 square inches area, and the weight upon it be only 5000 lbs., then the pressure exerted by it will be 714 lbs. per square inch, and the total pressure on the press ram 322,728 lbs. It will be seen from this that the smaller the section of the accumulator ram the larger the pressure exerted by it, provided the load be the same. This property is made use of in compressing black powder, gun-cotton, and similar explosives, by first exerting a small pressure by means of a large accumulator, and then large pressure by means of a small accumulator. If the larger pressure were to be put on at once, the ram would be lifted too slowly, and at the same time the counter pressure of the body to be compressed would increase at such an extraordinary rate that the compression would be done very badly. It will be seen, when treating of gun-cotton later on, how necessary it is, in order to eliminate the water from a body to be pressed, that the pressure should be small at the beginning and be applied gradually. But it is also very important with rigid bodies such as black powder, because the air must escape gradually, and what little elasticity the body has must first be overcome before real compression can take place.

With accumulators, so far as their work on a press is concerned, it does not matter if the pressure of the water entering the accumulator varies, so long as it is sufficient to lift the weights; and the more water enters the accumulator per second the quicker will this take place. The pressure exerted by the accumulator depends only on the area of the ram, and the load it carries, and the pressure it transmits to the press is not altered in the least if it is lifted at the same time by the water from the pump. The only requirement is that the areas of the pipes for inlet and outlet and the yield of the pump should be so chosen that the weights can never sink down to their lowest level.

From what has already been said about the distribution of the pressure and the surface of the press-table, it follows as a matter of course that the mass to be compressed must be at the same level in all the moulds, and must have the same proportions; otherwise it may happen that the total pressure exerted by the press acts in one mould only, and an excessive pressure is thus



given, which with explosives may be very dangerous. This is avoided by keeping each mould independent, and having for each a special pressing-piston, as is the case with Gruson's press, which will be described later, or as adopted in a press designed by the author, by making the moulds movable and independent of each other. This principle was invented by Otto Rost. Considering the tensile strength of cast-iron, which is the material generally used for the cylinders of presses, the diameter of the pistons is generally arranged so that the cylinder is exposed to a maximum pressure of 1500 lbs. per square inch. If higher, an exceptional thickness of metal for the cylinder would be required. The pistons are generally cast hollow to reduce their weight, and so relieve the pump of useless work. Since hollow rams have to be calculated as tubes subject to external pressure, and cylinders as tubes under internal pressure, and since also the bore of the ram is much smaller than that of the cylinder, the thickness of metal for rams is always smaller than that of the cylinders.



FIG. 127.

Leakage round the ram is prevented by using a cup leather (Fig. 127). It is a ring made of leather, or hard rubber, bent in the shape of a U. It is put into a groove in the cylinder, with the opening downwards, and presses on one side against the cylinder, and on the other side against the ram. The water entering the cup leather forces its sides outwards, and the more the pressure increases the more tightly it is pressed against the ram. In order to hold it up to its work a metal ring or a rope is placed inside it.

Hydraulic presses, therefore, consist of a strong cylinder and a piston packed by means of a cup leather, carrying the press-table. They have also, as a rule, two, three, or four columns, which are rigidly connected at one end with the cylinder, and at the other end with a cross-head. According to the use to which such a press is to be put, modifications in details have to be made.

Fig. 128 shows a prismatic powder press constructed by Taylor and Challen, of Birmingham, for the Royal Gunpowder Factory, Waltham Abbey. The base (B) and the head (C) are connected in the usual manner by four columns (A). The head and base

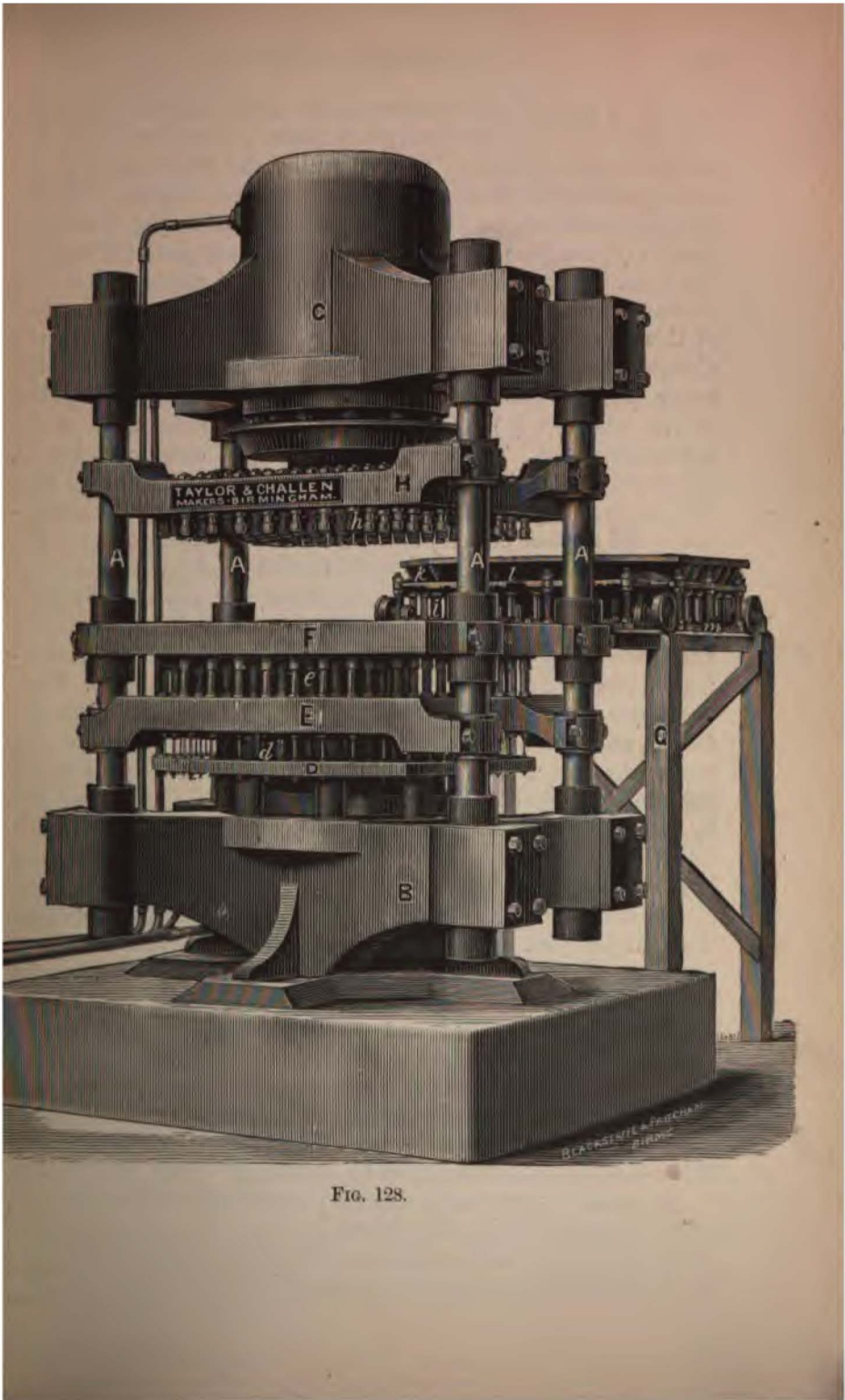

FIG. 128.

are cast in one with the upper and the lower hydraulic cylinders respectively. The base carries a plate (D) on to which the phosphor-bronze needles (d), for forming the perforations in the prisms, are fixed. Above these the lower ram carries the pressing-table (E), on which the lower plungers (e) are so arranged that the needles (d) can pass through them. The mould-plate (F) is above the lower plungers, and contains 64 hexagonal moulds; it is free to move vertically, and is guided by the pillars (A). To the rear of this stands a wooden frame (G), with rails on to which the charging-machine is run for filling. The top ram carries the upper plunger plate (H), on which are 64 corresponding but shorter plungers (h). They also have axial perforations to let the needles pass. The charger consists of 64 charging-tubes (i), above which 64 small funnels (k) are arranged. A plate (l) with 64 holes is arranged to move between the funnels and the charging-tubes, and another one (m) moves below the charging-tubes. For filling, the lower plate is so moved that the full parts of it stand opposite the bottom of the charging-tubes, and the same is done between the charging-tubes and funnels. The funnels are then filled with black powder, and the upper plate moved back, allowing the powder to fall into the charging-tubes and fill them. Then the upper plate is again closed, cutting off connection with the funnel, and the whole charger is moved on the rails into the press. As soon as it is in position with the charging-tubes standing exactly opposite the moulds, the lower plate is moved out by means of the lower lever, and the powder in the tubes falls into the moulds, which are closed at their lower end by the bottom plungers.

On compressing, the lower pressing-plate is first lifted, so that the plungers just close the moulds; these are then filled as described above, and pressure is admitted simultaneously to the lower and upper press-plate. After the pressing is finished the upper press-plate is lifted, and the lower one is allowed to rise, so that the prisms are pushed off the needles and out from the mould-plate, from which they are taken away by hand.

The time of pressing, which varies according to the state of the weather and the density required, is from 10 to 20 seconds. The whole operation lasts about two minutes.

A hydraulic press for prismatic powder built by the Grusonwerk at Buckau has several special features. It was constructed chiefly with regard to the manufacture of brown prismatic powder; but, unlike most machines, it has the great advantage of allowing

independent pressing of single prisms, thus obviating the risk of all the pressure exerted by the press being concentrated on to one single prism, should one mould happen to be more fully charged than the others. At the same time, the press exerts its pressure for a longer period, thus allowing the use of a lower pressure.

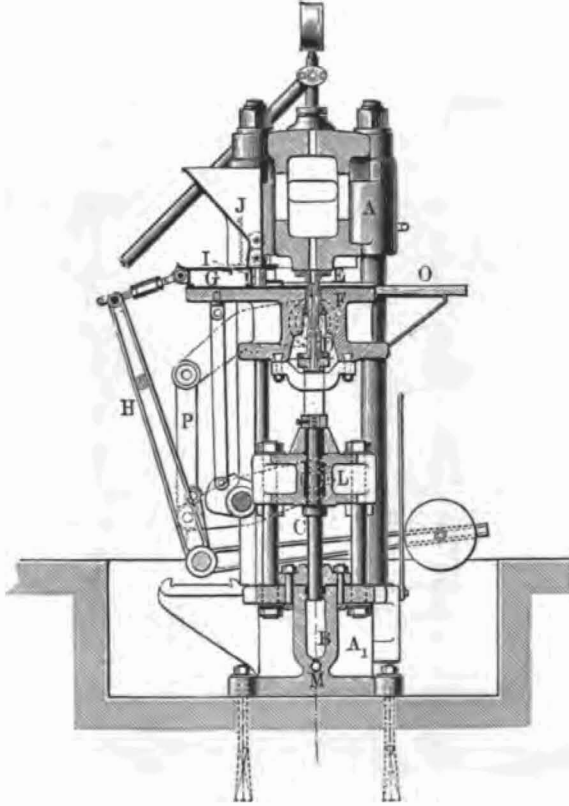

FIG. 129.—One-30th full size.

The Gruson press (Figs. 129, 130, and 131) consists of a base ( $A_1$ ) and a head ( $A$ ). The base has 10 pressing-cylinders ( $B$ ), each fitted with a ram ( $C$ ), to which the lower plungers ( $D$ ), made of phosphor-bronze, are attached. The upper plungers ( $E$ ) are fixed on to the head. The mould-table ( $F$ ) is movable, and is guided on the columns of the press. By this arrangement, as will be seen at once, each prism is compressed by itself.

The charging of the press is done by a movable slide (G), which slides on a prolongation of the mould-table, and can be pushed to and fro by a lever arrangement (H). The slide contains charging-tubes (I) opposite the moulds, and above them a filling-hopper (J). When pressing, water is admitted into the lower parts ( $\kappa$ ) of the cylinders in the head, and raises the mould-table, which in turn lifts the lower plungers by means of a cross-head

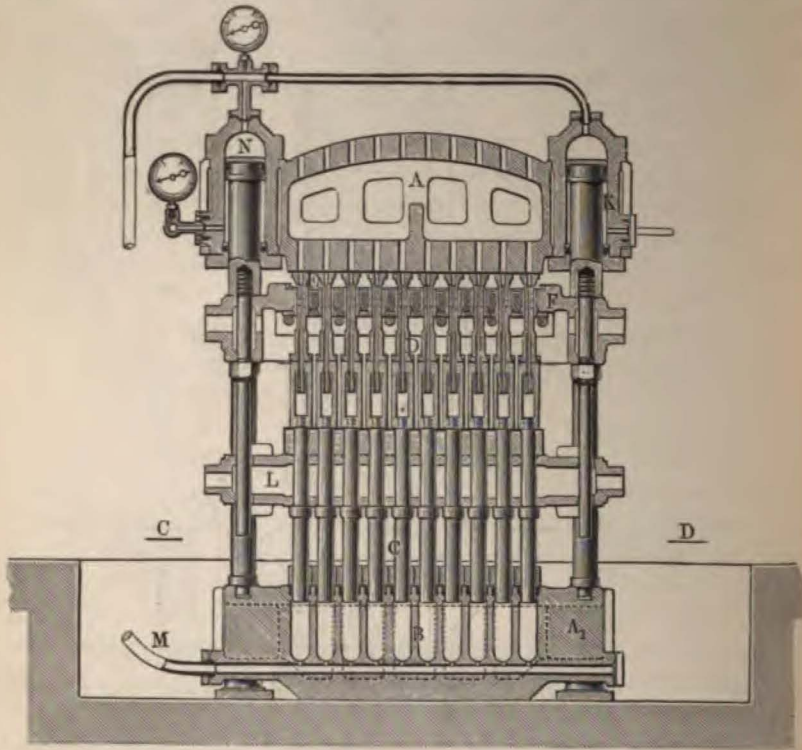

FIG. 130.—One-30th full size.

(L) arranged below it. As soon as the upper plungers enter the moulds on the upward movement of the table, the compression begins. Water is also admitted to the lower cylinder through the main pressure pipe (M) in the base, when the compression of the powder from below begins. After the pressing is finished, water is admitted into the upper part (N) of the cylinder in the head, causing the mould-table to slide down. As soon as the lower plungers have come down so far that compression ceases,



the lower cylinders are stopped, whilst the table continues its downward movement and pushes the prisms out of the moulds. They are then pushed away on to the small table (o) by the filling-hopper as it moves forward. The continued downward movement of the table finally causes it to touch a lever arrangement (p), which connects the table with the lower cross-head. By this the lower plungers are brought back into their lowest position, which is determined by the collars turned on them. As soon as the funnel has finished charging, an automatic reversion takes place, and the whole process is repeated. The inlet and outlet of the water to the cylinder is regulated by a special valve, which is opened on one end by the eccentric of a rotating shaft, and on the other end by the movement of the mould-table.

In England granulated powder is used for making prismatic

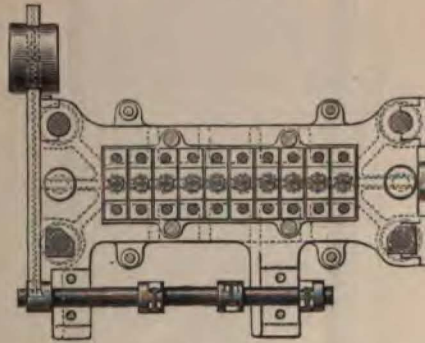

FIG. 131.—One-30th full size.

powder. The prisms are  $1\frac{1}{2}$  inches high, and have a density of 1.78 after drying. In Germany the prisms are 0.97 inch high, and measure 1.575 inches over the angles. Their weight is about 1.41 ounces, and their density 1.660.

The granulated powder used for the manufacture of prismatic powder contains about 4 per cent. of moisture when put into the hopper of the press. The more moist the powder, the more easily the pressing is done, but at the same time it must not be too moist, or saltpetre will effloresce on drying. In general, the height to which the moulds are filled depends to some extent on the moisture of the air, and it has, therefore, to be regulated accordingly.

After pressing, the prisms are dried in special drying-houses. As a rule trays are used, the bottoms of which are of narrow

wooden strips, with sufficient space between them to let the air pass from all sides, but not enough to allow the powder to fall through. At Waltham Abbey they are dried slowly for 140 hours, and after this they should not contain less than 1 per cent. moisture. At Spandau they are dried 48 hours at 122° F., when they should contain 0.75 per cent. moisture as a maximum.

Another kind of powder, made until recently in Great Britain, was the "Pellet" powder. The late Sir John Anderson, of Wool-

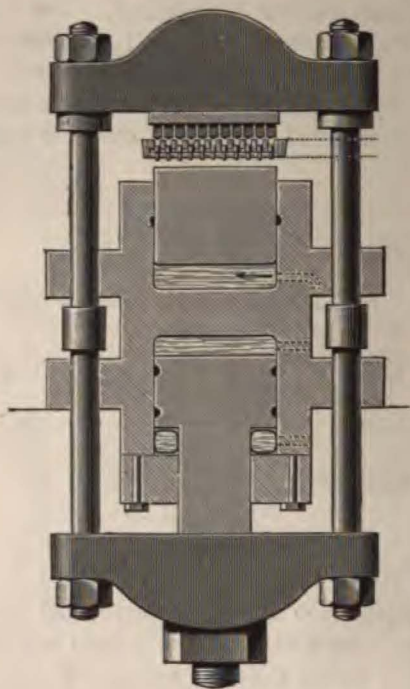

FIG. 132.

wich, invented a press for its manufacture, which is illustrated in Fig. 132. The pressing-table consists of a disc of about 6 feet diameter revolving about one of the columns. The disc has teeth round its circumference, and can be turned by means of a pinion and handle. It holds four round metal plates, placed symmetrically, which are about 2 inches thick and 1 foot 6 inches in diameter; in each there are 200 cylindrical holes of  $\frac{5}{8}$  inch diameter. Above each plate is a movable covering-plate, which can be pressed tightly against it, and into each of the 200 holes a small plunger



enters, which goes through the bottom part of the disc, and can be lifted from below by means of a hydraulic press. Two opposite plates are always pressed at the same time. As soon as the movable plates are lifted the moulds are filled with meal powder, the plates are cleaned, and the movable plates lowered and fixed so that they close the holes on the top. Then the plungers are pressed into the moulds, causing the layer of powder to be compressed to  $\frac{5}{8}$  inch in height. After this has been done, the movable plates are lifted, and the plungers are pressed forward towards the surface of the plates, pressing out the pellets from

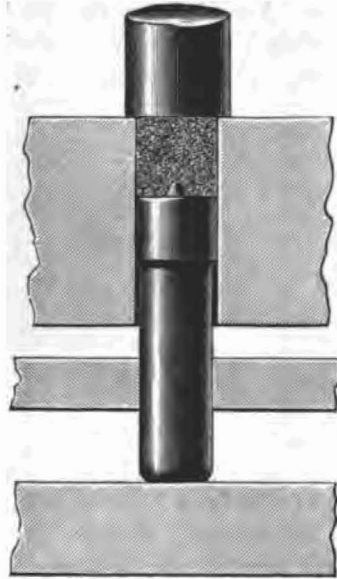

FIG. 133.

the moulds. The disc is then allowed to make one quarter turn, and the pellets are taken off the two mould-plates. The above operations are then carried out with the two other plates. The pressure applied is half-a-ton per square inch. The pellet has the shape of a flat cylinder, one or both bases of which have a hollow in the middle in the form of a blunt cone (Fig. 133). In order to produce this the plunger has a corresponding projection. The diameter of the pellet is  $\frac{5}{8}$  inch, its height  $\frac{5}{8}$  inch, and the depth of the hollow  $\frac{1}{4}$  inch. The density is between 1.65 and 1.70, and the weight 100 grains.

Compressed powder burns more slowly than ordinary large-grained powder, and is therefore less violent in its action. According to English experiments, its muzzle velocity is greater than that of large-grained powder and its pressure less by about one-half.

The Du Pont Powder Company, of Wilmington, Delaware, make a hexagonal powder known as "Du Pont" powder. It has the form illustrated in Fig. 134, in which two truncated hexagonal pyramids are connected by means of a cylindrical layer of powder. The compression is done in the following manner:—A lower plate in which a number of pyramidal recesses are cut is covered with powder. A second similar plate is laid over it, and the whole subjected to pressure. According to the thickness of the layer of powder, the cylindrical part connecting the two trunks will be thicker or thinner. After pressing, the cake is broken, thus



FIG. 134.—Full size.



FIG. 135.—Full size.

causing the grains to be broken off on the edges of the cylindrical part. In America this powder is used on a large scale.

In Italy, powder of the form illustrated in Fig. 135 was used for some time under the name of "Fossano" powder.

#### 4. PACKING.

Black powder is packed either in barrels or cases. As made, the barrels are, as a rule, already tight enough, but as an additional precaution the powder is put into a linen bag or, as in France, into a second inner barrel. For military or blasting powder the barrels used are sometimes made tight by pasting paper over the inside.

The powder cases are made of copper and contain the powder in a linen bag, or are made of wood with a second inner wooden box.

In the seventeenth and eighteenth centuries powder was packed

in Germany in barrels coated inside with linseed oil in order to protect it from moisture. In 1780 an interesting experiment was made in this direction at Hanover, but without practical consequences. Barrels containing powder were pasted outside with well-glued paper soaked in alum, then dipped into pitch, and stored under water for a month; the powder remained unaffected. In the same year an ordinance was made in Prussia prescribing that the powder should first be put into linen bags, and that these should be placed in a barrel which in turn was to be put into a slightly larger barrel. This method of packing was soon abandoned, and the powder was put directly into a barrel the tightness of which was determined by looking into it from a darkened room towards the light. Since on filling the barrel the upper hoops have all to be loosened and some taken off so that the upper end can be put in, the staves expand somewhat, and the openings produced are at once filled with powder, which is crushed on closing the barrel. If a grain of sand or some other body harder than wood gets in, a blow, even from a wooden hammer, may cause ignition. For this reason the powder, in the German Government factories, is now first placed in a bag, which is then put into a barrel. Each barrel is well closed with six to eight hoops. According to experiments that have been made, hoops from barked willow or hazel-wood (preferably cut in the winter) are better than unbarked ones, since the former do not suffer at all from rot. The bags are made of loose-woven unbleached linen, and closed at the sides and bottom by sewing, in such a way that they become gradually narrower at the bottom. At the upper end they have a seam and twelve holes through which a tape is run.

The powder is weighed directly into the barrels, the tare of which has been previously taken. The filling is done with an apparatus consisting of a copper funnel placed on a wooden frame. Each barrel is filled with  $115\frac{1}{2}$  lbs. of powder. The barrels containing rifle powder have a yellow label, those containing cannon powder a red label, and those containing meal powder a white label. At the bottom of the label the gravimetric density, the year and the place of manufacture, and the number of the supply are noted, and in addition, the seal of the examining officer is impressed on it.

The boxes are made of sheet copper  $\frac{1}{8}$  inch thick. A hole for filling is made in the cover, which is strengthened by having a brass ring soldered round it.

The prismatic powder is packed in boxes about 2 feet long, 2 feet wide, and 6 inches high. Each box contains 1314 prisms, the weight of which is 110 lbs. The boxes are made of oak or elm, and have two handles made of rope  $\frac{3}{8}$  inch thick. A piece of felt is laid on one of the ends of the box, and the prisms put in 12 rows of 10, and 11 rows of 9, six layers being put in such a way that they lie tight against each other. As soon as the last row is packed, another piece of felt is laid along the whole length and the cover screwed on. The felt is to prevent the edges of the prisms being broken.

In Austria military powder is packed in the same way as in Prussia. The linen bags generally hold  $246\frac{1}{2}$  lbs., though sometimes  $123\frac{1}{2}$  lbs. only. The prismatic powder is packed into boxes in which a lining of brown paper is pasted. Whole boxes contain 64 lbs.; half-boxes  $39\frac{1}{2}$  lbs. Meal powder is packed in bags, and these in wooden boxes with a lining of paper. Every four years the whole stock of the magazines, or every year the fourth part of it, is changed into fresh bags and barrels. The object of this changing is to again examine the powder and to eliminate any that has become damaged.

In France, in the seventeenth century, powder was packed in the same way as it is now-a-days in Germany. At the beginning of the last century (1704) barrels were introduced instead of bags. The barrel proper (baril) was lined inside with cloth, and was filled with 110 lbs. of powder. This was placed in a second barrel (chape). This kind of packing is still in use, except that the cloth lining is omitted. The barrel is 2 feet  $0\frac{1}{8}$  inch high, 1 foot  $5\frac{3}{4}$  inches in diameter at its widest part, and has 14 staves which are  $\frac{1}{2}$  inch thick at the ends and  $\frac{5}{8}$  inch at the centre. Each of the two ends is made in three parts, and each barrel has 20 hoops. After it has been ascertained that the barrel is up to the requirements, it is closed and put into the second larger barrel. On one of the ends of the outer barrel the year and place of manufacture, the kind of powder, the average range, and the average muzzle velocity are noted. More recently rectangular wooden boxes lined outside with sheet-zinc have also been used, which are placed in a second wooden case. A rectangular hole serves for discharging. Each case contains 50 kilogrammes. Sporting powder is placed in tins holding 2000, 1000, 500, 200, and 100 grammes respectively. The tins are packed in boxes holding 25 kilogrammes each. Mining powder is put into tight linen bags, holding 25 or 50 kilogrammes, these being afterwards packed

in barrels. For sea transport, copper cases enclosed in wooden ones are used.

In England, powder is placed directly into barrels holding 100 lbs. Since these barrels are made very carefully, the use of a linen bag is considered unnecessary. In 1810, according to Pichat, the barrels were only filled to  $\frac{1}{10}$ ths of their capacity, since it was believed that by rolling the barrel the powder was prevented from caking. For this purpose the barrels were rolled every year over a copper plate on the floor of the magazine.

In order to avoid all danger connected with the storage of large quantities of gunpowder, Piobert in 1840 recommended a modification in packing—namely, mixing the powder with very fine powder-dust instead of using pure grains. He imagined that when the space between the grains was filled with dust, the propagation of the flame would take place very slowly. According to his experiments, the rate of combustion would only be between 7 inches and 12 inches per second, according to whether the mass were compressed or not.

Fadéieff, following up this suggestion, made a number of experiments, and recommended that powder should be mixed in barrels with powdered charcoal and black-lead in the proportion of two parts of powder to one of charcoal and black-lead together. The mixture was then to be placed in barrels as nearly cylindrical as possible in form, the bottoms of which were covered with a layer of about 2 inches of charcoal and black-lead. The black-lead gives plastic properties to the whole mass, making the mixture more compact, so that the grains are only separated with difficulty by shaking. By this method of packing the powder becomes less easily inflammable, and also burns very slowly and without explosion when ignited. A quantity of powder of 70 lbs. (not including the charcoal and black-lead) required between 67 and 75 seconds for complete combustion. The flame issuing from the barrel was between 5 feet and 7 feet long. It was proved that there was no danger in standing near the barrel, and that the latter was quite serviceable after its contents had burned out.

When making these experiments, Fadéieff also noted that powder thus mixed with charcoal and black-lead only absorbed one-quarter as much moisture as the same weight of powder not so treated. To make the powder thus packed serviceable, it is sifted before use, and the charcoal and black-lead sifted out can be used again.

Another process, which was carefully examined in 1866, by

the English War Office, was proposed by Gale. Common glass heated to a white heat, and then dipped into cold water, is converted into fine powder, and mixed with black powder in the proportions 2 : 1, 3 : 1, or 4 : 1, according to whether it was intended to make the powder either not explosive or altogether incombustible. Powder thus mixed can be carried without any danger, and even thrown into a fire. In order to make it again serviceable, it is sifted.

However desirable in general the two methods may appear, there are grave objections to their practical use. In the case of the powder being suddenly wanted, for instance if war breaks out, the sifting requires so much work that there is not always sufficient time and labour at disposal. Moreover, the work connected with it gives rise to far more danger than has been avoided by adopting the method for storing. As regards Fadéieff's process, it must be especially mentioned that the black-lead coats the grains, and that after sifting the powder will burn much more slowly, and therefore be less serviceable for small arms; although, as Fadéieff asserts, the hygroscopic mixture of charcoal and black-lead is of advantage in storing for a few days only. This will be different when the powder is stored for a number of years, since the charcoal will gradually give up its moisture, or at least the greater part of it, to the powder.

### 5. RE-SHAKING.

In France powder was formerly examined once a year for moisture. For this purpose it was re-shaken in the magazine, which was done as follows:—The barrels were rolled on the floor of the magazine, which was covered with hair rugs. If the sound was uniform, then the powder was good. Any powder found to be moist was dried in the air, if its moisture were not more than 6 to 7 per cent. The barrels were also dried, and after dusting it the powder was again packed. If it had clogged into lumps, they were broken by hand; and if the barrel was moist, the powder was put into a dry one and well shaken in order to divide the lumps. Powder so re-worked was not put into its original place again, but what had been lying below was put on the top, and *vice versa*. If the moisture of the powder were more than 7 per cent., or if the saltpetre had begun to effloresce, then the powder was again stamped, after it had been determined by a quantitative analysis that the proportions had not altered.

In order to determine the moisture three samples of the powder to be examined are taken—one from the bottom, one from the centre, and one from the surface of the barrel; then the samples are carefully mixed and 5 grammes are weighed out, dried, and again weighed.

In Prussia, powder was formerly exposed to the sun every two years, but it is now only done every eight or ten years in all cases where the magazines are dry and well adapted for storage.



## CHAPTER IV

### EXPLOSIVES RELATED TO BLACK POWDER

It has previously been stated that the composition of black powder, as it has been developed in the course of centuries, may be regarded as the most suitable one for producing the best effects for the purpose it is usually applied to. Various circumstances have nevertheless led, especially in the present century, to the invention of other kinds of powder in which either some components were replaced by others, or, more rarely, a totally different percentage of the same components was preferred.

Probably the chief reason has always been the production of a cheaper powder for use in mines, on railways, and similar works, or one better adapted for certain special operations. In Austria-Hungary especially, there is another circumstance which has led to such alterations—namely, that in that country the manufacture of gunpowder is a State monopoly, which has nevertheless been relaxed in favour of blasting explosives, the composition of which differs from that of black powder. At the same time, the price of Government-made blasting powder was not sufficiently reduced to compete with the private manufacturer.

In the civil engineering operations mentioned above, it is, as a rule, necessary to have a blasting material which, whilst it has a sufficiently high rate of combustion, does not shatter the rock much, but fissures it extensively. This cannot always be done with very violent and quickly-burning explosives, and even black powder is sometimes too violent. Widely differing materials have therefore been used in such other powders. More especially other oxygen-carriers have been selected in the place of saltpetre, and cellulose bodies in the place of charcoal. It is hardly possible to eliminate sulphur from black powder. This component is so essential to the combustion of powder, that it

was difficult to omit it, even when the latter was intended for very special purposes. Moreover, powder free from sulphur has the tendency of quickly falling into dust.

It is not the author's intention to refer here to all the various mixtures which have been proposed for replacing black powder. Their number has become so large that their mere enumeration would fill a large part of this work. It is also unnecessary, as the late Lieut.-Colonel Cundill, in his 'Dictionary of Explosives,' and afterwards Désortiaux, in his translation of Cundill's book, which appeared in the 'Mémorial des Poudres et Salpêtres,' and Corvette-Captain F. Salvati of Rome in his 'Vocabolario di polveri ed esplosivi,' have given very extensive lists of all explosives suggested at various times; and to these the reader is referred. The author, therefore, will only speak of those powders that are manufactured at the present time. The same also applies to explosives in general.

## 1. POWDERS WITH SUBSTITUTES FOR SALTPETRE.

### (a) *Powders containing Sodium Nitrate.*

The principal difference between sodium nitrate and saltpetre is the much lower cost of the former; but it has also the advantage that, on account of the low atomic weight of sodium, more oxygen is contained in the same weight of the salt, and it can therefore bring about a more complete combustion. The use of sodium nitrate has, however, always been attended with great difficulties, when the powder made with it was intended for keeping for a long time, because sodium nitrate is very hygroscopic. Chemically pure sodium nitrate is fairly stable in the atmosphere, but the sodium nitrate of commerce has always a certain percentage of nitrates and chlorides of calcium and magnesium which it is difficult to eliminate, and which, according to Gentele and Cronquist, are the causes of the hygroscopic properties of powder.

At present the following powders containing sodium nitrate are manufactured:—

*Diorrexin*, invented by Wenzel Pancera, which, according to an analysis, contains—

Saltpetre	...	...	...	...	42·78
Sodium nitrate	...	...	...	...	23·16
Sulphur	...	...	...	...	13·40
Charcoal	...	...	...	...	7·49
Beech sawdust	...	...	...	...	10·97
Picric acid	...	...	...	...	1·65
Moisture	...	...	...	...	0·55
					100·00

*Azotine*, invented by A. Bercsey, consists of sodium nitrate, sulphur, charcoal, and petroleum residue.

The powder made with sodium nitrate under the name of *Haloxylin*, by Fehleisen Brothers, is described under "powders without sulphur."

Powders containing sodium nitrate are not manufactured at present outside of Austria-Hungary.

(b) *Powders containing Ammonium Nitrate.*

What has been said of sodium nitrate applies in a still higher degree to ammonium nitrate. It is so hygroscopic that it soon becomes liquid in the open air. For this reason the manufacture of powders with this kind of nitrate has always been avoided. The *Amide* powder made at the Rottweil-Hamburg factory, which, according to Sir Andrew Noble, consists of 40 parts of saltpetre, 38 parts of ammonium nitrate, and 22 parts of charcoal, is an exception. It burns with a slight smoke, has great energy, and is recommended as a good substitute for brown powder.

(c) *Powders containing Barium Nitrate.*

J. R. Wagner first pointed to the possibility of using barium nitrate instead of potassium nitrate. He also first proposed its manufacture from "Witherite" in a similar manner to that of saltpetre. Newton made it from barium chloride and sodium nitrate, and called his powder mixture "Saxifragine." Captain Wynants, a Belgian, made extensive experiments with a powder in which four-fifths of saltpetre were replaced by barium nitrate. Although barium nitrate is not hygroscopic, it has not come into use on account of its higher price, and because the powder made with it is less inflammable.

(d) *Powders containing Potassium Chlorate.*

Whilst in the use of nitrates, especially sodium nitrate, cheapness was the great object, the reason for introducing potassium chlorate was to attain a greater effect. As will be seen from the atomic weight of the salt, it has, compared with saltpetre, for which it is substituted, less oxygen at disposal for the same weight, but this it gives off much more easily and quickly, and the decomposition is not only a complete one, but the gases expand rapidly through the large amount of heat developed and give a considerable pressure. Although such kinds of powder cannot be used in fire-arms on account of their very rapid rate of combustion, it is just this property that would make them very advantageous for some blasting purposes; but powders containing potassium chlorate have the great disadvantage that they are extremely sensitive to shocks, and that, consequently, not only is their manufacture very dangerous, but also their use in the hands of miners—who from the nature of their occupation cannot handle explosives very gently—is attended with constant dangers. In Great Britain, therefore, explosives containing large quantities of potassium chlorate are not licensed for manufacture or transport. Nevertheless, the number of powders suggested containing potassium chlorate is a very large one. They are frequently also called “muriatic” powders. This designation was originally due to Berthollet’s detonating powder, which contained potassium chlorate in the place of saltpetre.

The following chlorate powders are now manufactured:—The *Himly* powder, of *C. Himly and Von Trütschler-Falkenstein*, containing—

				PARTS.
Potassium chlorate	...	...	...	45
Saltpetre	...	...	...	35
Coal pitch	...	...	...	20
				<hr/> 100

The pitch is dissolved in benzene, the salts mixed with it, and the benzene evaporated.

*Poudre des mineurs* (miners’ powder) of *Michalowsky*. Its composition is—

				PARTS.
Potassium chlorate	...	...	...	50
Manganese	...	...	...	5
Bran	...	...	...	45
				<hr/> 100

*Comct powder (American)*—

	PARTS.
Potassium chlorate ... ..	75
Resin (from pine-wood) ... ..	25
	100

Chlorate powders are generally mixed in drums with wooden balls, or in mixing-machines with a rotating brush. Sometimes the potassium chlorate, and if it was contained in the powder the saltpetre also, was dissolved in water and the carbonaceous matter soaked in this solution, after which the mass was dried. Kellow and Short suggested such a process as early as 1863.

On account of its historical interest the "shooting paper" of Melland deserves mention, and also the white powder of Augendre and Pohl.

The composition of *Melland's shooting paper* was—

	PARTS.
Potassium chlorate ... ..	9
Saltpetre ... ..	4½
Ferro-cyanide of potassium ... ..	3½
Charcoal ... ..	3½
Ground starch ... ..	⅙
Potassium chromate ... ..	⅙
Water ... ..	79
	100⅙.

The mixture was boiled for an hour, and unsized paper first dipped into the solution, then rolled into cartridges and dried at 122° F. In order to make it moisture proof, it was coated with a solution of one part of nitro-cellulose in three parts of acetic ether.

*Augendre's powder*, which was improved upon by Pohl, consisted of—

	PARTS.
Potassium chlorate ... ..	49
Sugar ... ..	23
Ferro-cyanide of potassium ... ..	28
	100

For some time this was frequently experimented with and tested on account of its alleged freedom from danger and greater power, but it, too, has fallen out of use.

**2. POWDERS WITHOUT SULPHUR.**

The only powders containing no sulphur at all which have come into practical use are the above-mentioned *Amide* powders and the *Haloxylin* of Anders and Fehleisen. The latter, which is still manufactured in Austria, contains—

	PARTS.
Saltpetre ... ..	75
Sawdust ... ..	15
Charcoal ... ..	8½
Ferro-cyanide of potassium ... ..	1½
	100

A powder sold by Fehleisen Brothers under the same name has the same composition as that of Anders and Fehleisen, except that it contains sodium nitrate in the place of saltpetre.

**3. POWDERS WITH SUBSTITUTES FOR CHARCOAL.**

With all those explosives in which charcoal is replaced by other carbonaceous substances, the latter could rarely effect an increase in the inflammability of the powder. They naturally slackened its combustion, although they sometimes made up for this defect by giving off larger quantities of gas.

For this reason, and also because they generally left considerable residue, they were unsuitable for use in fire-arms, but were more adapted for blasting purposes. As substitutes for charcoal there have been proposed, amongst other materials, coal, coke, humus acid, catechu, sugar, sawdust, bark, bran, glue, dextrin, starch paste, gum, ferro-cyanide and ferri-cyanide of potassium, tartaric acid, Seignette's salt, and sodium acetate. At present the following powders are manufactured:—

The *Petralite* of A. Prohaska, consisting of saltpetre, sulphur, wood pulp, and coke powder. It is manufactured in the usual manner and glazed with black-lead.

The *Janite* of A. Jahn consists of—

	PARTS.
Saltpetre ... ..	70
Sulphur ... ..	12
Lignite coal ... ..	18
Picric acid ... ..	0·4
Potassium chlorate ... ..	0·4
Calcined soda ... ..	0·3
	101·1

Janite is a chocolate-coloured powder sold in fairly large grains, and is a carefully manufactured explosive which has proved to be suitable for mining purposes.

The *Carboazotine of Raymond Cahuc*. This powder was sold in Great Britain under the name of *Safety Blasting Powder*, but its manufacture has been discontinued in this country. It consists of—

	PARTS.
Saltpetre ... ..	64
Sulphur ... ..	12
Lamp-black ... ..	7
Bark or wood pulp ... ..	17
Sulphate of iron ... ..	... 1 to 5
	101 to 105

A similar powder was made by John Gemperle under the name of *Amidogène*. It contained—

	PARTS.
Saltpetre ... ..	73
Sulphur ... ..	10
Charcoal ... ..	8
Bran or starch ... ..	8
Magnesium sulphate ... ..	1
	100

These powders were made by a method long known to the Tartars. The ingredients were first mixed in a drum with a paddle-shaft which rotated in the opposite direction to the drum. After having been mixed for fifteen minutes, the green charge was transferred to a boiling apparatus, illustrated in Fig. 136, and a large quantity of water added to it.

The apparatus is essentially a steam-jacketed pan. The pan (A) is of cast-iron and surrounded by a steam-jacket (B), which is so arranged that it can be tipped in the bearings (D). The trunnions (C) are hollow, and at their outer ends are stuffing-boxes (E), through which pass on one side a steam inlet-pipe and on the other an outlet-pipe. The latter passes down to the bottom of the jacket and serves for getting rid of the condensed water through a steam-trap. This automatic arrangement is replaced in some cases by a tap at the bottom of the jacket. A shaft (F) with paddles (G) rotates in the pan and stirs the boiling paste in order to prevent it from caking. The paddle-shaft is actuated by a horizontal shaft (H), and is in two pieces, which are connected by a square muff. This serves for disconnecting when the boiling



is finished, and thus allows the pan to be tipped through  $90^\circ$  in order to discharge its contents.

In this apparatus the charge was boiled with continuous stirring, until the major part of the water was evaporated. Towards the finish the development of steam caused a constant spurting of the paste, so that the faces of the workmen had to be protected by masks. When the boiling was finished, the pulp was spread out in flat wooden boxes and constantly raked, whereby a further amount of steam was given off, whilst at the same time the saltpetre crystallized out and the powder agglomerated into large and smaller grains. After this the carboazotine was either

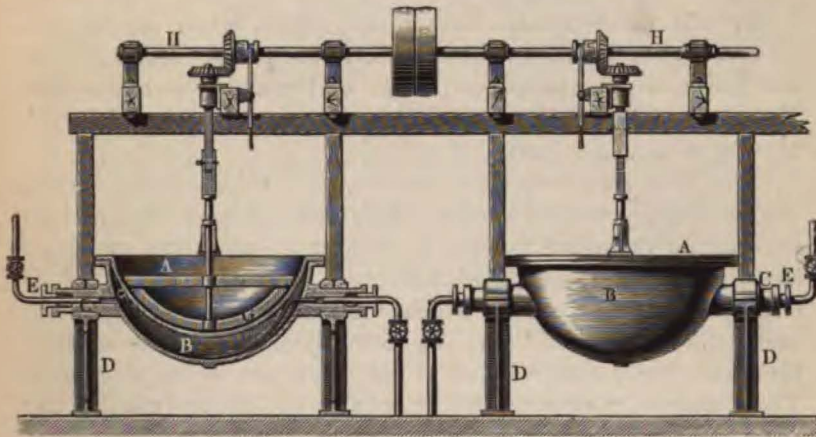

FIG. 136.—One-36th full size.

dried immediately, or broken into smaller grains by means of crushing-rolls and then dried.

This powder has a very slow rate of combustion, but develops large quantities of gas. It has been used on a large scale in chamber mines for the blasting operations at the Iron Gates on the Danube. Its use is advantageous in certain coal-mines, because it does not shatter the coal.

Powders made by a boiling process are never perfectly mixed, because the saltpetre tends to crystallize out, forming rather large crystals, which separate from the rest of the ingredients; and also because, even with continuous stirring, the sulphur, on account of its higher specific gravity, has a tendency to sink to the bottom and to form small separate nodules on cooling.

## CHAPTER V

### ABSORBING POWDERS FOR DYNAMITE

It will be seen later that nitro-glycerin when mixed with various highly absorbent substances, forms plastic bodies, which are known under the general name of Dynamite, and also that these absorbing materials can be divided into two classes—namely, active and inert.

The inert absorbing materials are, as a rule, mineral earths, the preliminary treatment of which has already been dealt with in the chapter on prime materials. The active absorbing materials are, on the other hand, always mineral, or organic bodies, of an easily combustible nature, which will also, as a rule, detonate under the influence of exploding nitro-glycerin. Sometimes they also cause the presence of an excess of oxygen in the dynamite. These absorbing powders rarely consist of one body only, but are usually mixtures, the ingredients of which are so selected and their proportions so arranged by calculation or by experience, that they burn completely into carbonic acid and water. In their most perfect form, therefore, they constitute a true powder.

The ingredients and their best proportions will be dealt with in the chapter on dynamite. As far as their manufacture is concerned, they may be classified with mixtures similar to black powder.

In making absorbents with active bases, or, as they are commonly called, "absorbing powders," the various kinds of nitrates—such as nitrate of potassium, sodium, and ammonium, and organic matters, such as wood pulp, rye-flour, charcoal, coal, etc.—have to be considered. Very often sodium carbonate is added to the absorbing powder, and more rarely sulphur. As the absorbing powders should burn completely, they must be pulverized as finely as possible; but, on the other hand, they must also serve as absorbents, or at least assist the cohesion of the

explosive as a whole. Bodies with a tough texture, like charcoal and coal, have a higher absorbing capacity when finely powdered than when in a coarse state, whilst wood pulp must not be too finely divided, as its absorbing capacity will suffer.

As a rule, the nitrate is dried on steam-heated iron shelves, during which process it is frequently raked over. Nitrate of ammonium, when so treated, becomes acid through part of its ammonia being driven off, and the iron plates are consequently corroded. After drying, the nitrate is ground to a fine powder in suitable mills, for which purpose Gruson's "Excelsior" mills may be used with advantage, or small mills with vertical stones, the distance between which should be adjustable. This is usually done by setting up one stone by means of a screw and hand-wheel. Too high a speed in such a mill must be avoided, or the saltpetre is liable to ignite by the great heat developed. Nitrate of ammonium, when quite dry, rapidly absorbs moisture, and it is therefore best to grind it whilst still warm direct from the drying apparatus, and also to keep the room in which the grinding is done at a temperature of about 86° F. Sometimes the mill itself has to be surrounded by a steam-jacket.

Wood pulp is, as a rule, supplied in a sufficiently fine state; nevertheless, it is advisable to let it pass through a fine cylindrical sieve before using it, in order to remove any foreign particles which may have got into it by accident. Coal and charcoal are pulverized with iron balls in charcoal drums, as described on p. 189. Wood pulp and rye-flour are roasted in order to eliminate all moisture, and to make them more combustible by very slightly charring them. For this purpose they are put into wrought-iron drums set in a fire-place, the drums being sometimes provided with a wrought-iron paddle-shaft, which can be turned by means of a handle. A pipe leading into the open air from the highest point of the drum carries away the moisture, and the other gaseous products driven off. As a rule, it is sufficient to rake over the contents from time to time with wooden rakes. Sometimes large cupboards, in which loose shallow iron trays can be placed on bearers, at suitable distances apart, are used in place of the drums. The temperature of these furnaces is kept at about 250° F., at which temperature all the water is driven off, and the wood pulp, or rye-flour, becomes slightly coloured, taking a yellow or faint brown tinge. It is necessary to rake the material over frequently, because otherwise some parts, especially those against the walls

of the drum, will become more highly charred, and it is also quite possible for single particles to become incandescent inside the mass itself and form black charcoal, with the possibility of the whole contents of the drum taking fire. After roasting, the wood pulp, or rye-flour, is put into tightly-closed vessels to cool.

The ingredients thus prepared for the absorbing powder are intimately mixed together by the aid of *lignum vitæ* balls in mixing-drums, similar to those illustrated on p. 189. Sometimes, especially if the absorbing powder be not easily combustible, a wrought-iron drum is used, through which a paddle-shaft passes. In this case the drum and paddles are rotated by means of suitable gearing in opposite directions, the drum revolving at half the speed of the paddle. This effects a very intimate mixing in a short time. The fine absorbing powder is kept in closely-woven, tight linen bags, or in boxes lined with zinc. It should, however, be used as fresh as possible, because, in spite of all precautions, it may absorb, even by standing over-night only, about 2 per cent. of moisture. Although, strictly speaking, absorbing powders are not powder mixtures, they are nevertheless easily combustible, and liable to take fire sometimes. It is therefore advisable to isolate the building in which they are prepared, and also the various compartments of it, by means of stone walls, and to make the roofs of iron, or to have fireproof ceilings in them.

## CHAPTER VI

### GENERAL REMARKS ON BLACK POWDER FACTORIES

FOR some considerable time after the general introduction of black powder it continued to be made within towns. As already mentioned in the historical part, the town-hall of Lübeck was set on fire in 1360 by the negligence of those "qui pulveres pro bombardis parabant." In 1528 the town council of Breslau issued a decree prohibiting the making of powder within the town. It would therefore seem that for some two hundred years the manufacture of powder was tolerated in the inhabited parts of towns.

On the Continent, until about thirty years ago, powder was made in the so-called powder-mills, which were placed outside the inhabited localities, but arranged without special consideration as to the distance of the buildings from each other. It is only during the last few decades that increased attention has been given to the question of safety inside factories. Nearly every Government has now issued regulations specifying the distance of the factory buildings from the inhabited houses and from each other, and also the quantities which may be worked at a time in each building. These will be referred to at length later on.

Since powder factories require a considerable amount of motive power, they are generally erected where a large water-power is available, which leads to the use of a special kind of plant. On the other hand, there are many places where there is insufficient water-power, or none at all, in which case the work is done by means of steam-power, and another kind of plant is necessary.

As a rule, in a water-power plant the machines required for the same operation are arranged in pairs, in such a manner that one or two are to the right and left of the wheel-room. For this purpose a massive brick or stone building is made, in which the water-wheel, or, if desirable for the safety of working, two of

them, one for each wing, are placed. The main shaft of the water-wheel passes through openings left in the brickwork, which are covered with sheep-skin in order to prevent dust getting through.

The powder is transmitted to the various machines by means of cog-wheels. The wings, in which the machines are placed, are generally made of light material, but more recently massive buildings have been preferred, with walls up to 3 feet 4 inches thickness, except on one side, where there is either a glass and wood frame wall or a very light, loosely-fixed wooden wall.

In Austria the regulations require the buildings to be made of light boards, or lattice-work.

The French Government powder factories have, according to the position of the building, three, two, and sometimes even only one massive wall.

In Germany either wooden buildings are preferred, or, especially for incorporating-mills, buildings with strong brick walls. Sometimes a device of Hermann Güttler, of Reichenstein, is adopted, in which the roof is laid on quite loosely, being only fixed to the walls by means of two wooden pins, so that in the event of an explosion it is, as a rule, only thrown down, and not destroyed. A similar arrangement is generally adopted in this country for incorporating-mills, but the other buildings are usually made of wood.

With water-wheels the transmission of power is comparatively simple, since with a given head of water it is possible by means of races or pipes to bring the water-power to the wheels, which are generally placed in the buildings themselves. Sometimes a mixed arrangement is found, where the power produced by a large water-wheel is transmitted to the various buildings by means of a wire rope. For this purpose a changing station is arranged in a suitable place, where one pulley takes the rope coming from the water-wheel, or other motor, while a second one transmits the power in the direction desired. The second pulley is either fixed on to the shaft, or there is a second shaft in a suitable angle driven by a pair of cog-wheels from the first shaft.

When steam-power is used there are two methods of working available. First, that in which a central steam-engine of large dimensions produces the whole of the power required, this being transmitted to the various buildings by means of wire ropes. In such a case the buildings may be arranged in a semi-circle round the central station, as has been done at the French powder factory at Sèvres-Livry, or there may be a parallel rope trans-

mission, or intermediate stations in suitable places. In the second arrangement for a steam-driven factory, a large boiler plant is put up for the production of steam, which is carried by means of pipes to the various buildings, in which are small steam-engines, either one for each building, or a common one for a group of buildings.

Opinions differ as to the value of the various arrangements for transmitting power. Generally speaking, water-wheels have a comparatively low efficiency, but they are cheap to erect, the working costs are very low, repairs and grease only as a rule, the water—the source of power—generally not costing anything. Where, therefore, water-power is at disposal, no other arrangement can be thought of. It is, however, different with a steam-driven factory. Now-a-days large steam-engines are made of very high efficiency. As far as a central engine plant is concerned, it cannot be doubted that it may be worked economically; but if it is a question of transmitting the power produced in such a central station to the large distances with which one has to deal in powder factories, the question of economy of working becomes a difficult one to solve. Transmission by wire ropes gives rise, theoretically, to only a small loss of power, but in reality it becomes considerable. It is absolutely necessary that the rope pulleys should be placed in a perfect line with each other in order to avoid great loss of power; that continuous attention be given to greasing and keeping the plummer blocks in order; and also that the rope pulleys themselves should be carefully turned and their grooves lined either with leather or wood on edge, so that the wear of the rope is reduced to a minimum. For the same reason pulleys should not have too small a circumferential velocity—generally about 40 to 50 feet per second is sufficient. In spite of all these precautions a considerable loss of power, even with straight transmission, cannot be avoided, because, especially when the rope becomes slack, oscillations of the rope will take place—that is to say, its adhesion is not sufficiently great to counterbalance the pull produced by the sagging, and the consequence is a sudden jerk on the rope.

The loss of power becomes still more considerable if it is a question of transmitting power at an angle. Here also the pair of bevel wheels required cause theoretically a minimum of loss; but if these cog-wheels are not fixed absolutely exactly according to the angle of the teeth, if they are not made with the greatest care, and if the cog-wheels get worn in course of time, they very frequently cause very considerable losses, amounting to many



horse-powers. A rope-transmission system has the further disadvantage that in the case of a rope breaking whole sections of the factory are rendered idle.

Under these circumstances it is in most cases only a question of calculation whether it is not advantageous to carry the steam to a greater distance in suitably lagged and covered pipes, and to place in each building a small steam-engine, or to provide a common engine of medium size for separate groups of buildings.

The protection of steam-pipe lines can now be effected by means of non-conducting compositions, such as "fossil-meal," in such a perfect manner that the loss of steam and pressure becomes comparatively very small; and small engines can also be obtained, giving very good results, so that they can be used with advantage instead of large engines. The opinions as to the best way of distributing steam are fairly divided. Very frequently steam-pipes of an internal diameter of 6 inches and more are used, while others prefer several pipes of smaller diameter, about  $1\frac{1}{2}$  to 2 inches. It is necessary to carry large pipes in subterranean brick channels, and to provide special expansion joints, chiefly with stuffing-boxes, for compensating the expansion of the pipes; and the pipes must of course rest on rolls to allow free movement. Such large pipes are not easily accessible if any joint is leaking, and the condensation also is not inconsiderable. They have, moreover, the disadvantage that, in the case of breakage or leakage, whole sections of the factory are brought to a standstill, and when such buildings are not working, the condensation in the pipes is the same as if all of them were in work. It is consequently often advantageous to substitute a number of smaller pipes carried on wooden poles or iron columns, which start from a common steam-distributor in the boiler-house, each pipe having its own valve on the steam-distributor, so that they can be cut out of work separately. If the diameter of these pipes is not more than two inches, they can be carried in a simple way in rings or iron hooks, so that the expansion is taken up by their giving sideways. If a long line of piping is run in a straight line, it is also possible to provide a loop, or a U-piece, to take up the expansion, such U-pieces, or loops, being of course provided with a steam-trap at their lowest point.

Since the protecting composition easily becomes moist in spite of its being covered with cloth and repeatedly tarred, and thereby gives rise to loss of heat, it is best to cover it over either with waterproof paper or waterproof cloth. Of course a piece

of suitable length must remain uncovered at the points where the pipe is suspended, to leave room for expansion.

Special attention must be given to the shafting inside the buildings; at the points where they pass through the wall, sheep-skin or felt is, as a rule, put round to prevent dust getting through the openings. Cog-wheels, unless they have wooden teeth, should, as far as possible, be placed outside the buildings; or, if this cannot be done, they should be enclosed in a tight box. It is of advantage to place the whole of the shaftings in a little annex, and to let only the belts pass through the wall. Of course the floors must be perfectly tight.

Other necessary precautions in erecting buildings for powder factories will be dealt with in a subsequent chapter.

The power required for driving the various machines is, according to Désortiaux, as follows:—

	HORSE-POWER.
Iron binary drum, 264 lbs. of balls, 20 to 28 revolutions per minute—France ... ..	1·75
Ternary leather drum, 220 lbs. charge, 220 lbs. balls, 20 to 25 revolutions per minute—France ... ..	1·30
Stamp-mill with stamps of 88 lbs. weight, 55 to 60 blows per minute—France ... ..	0·30
Pair of incorporating-mills, each between 5 and 6 tons weight, 44 to 50 lbs. charge, 10 revolutions per minute—France ... ..	6 to 7
Granulating machine, eight sieves, 75 to 80 revolutions per minute—Germany ... ..	1·5
Granulating machine, 12 sieves, 70 to 75 revolutions per minute—France ... ..	2·5
Roller granulating machine, of Waltham Abbey—Great Britain ... ..	3 to 4
Granulating-drum—France ... ..	0·8
Granulating-drum and mechanical sieve—France ... ..	2
Glazing-drum, with two compartments, 12 cwt. charge, 12 to 14 revolutions per minute—France ... ..	2·5 to 3
Glazing-drum, with two compartments, 440 lbs. charge, 16 revolutions per minute—Germany ... ..	1·5
Glazing-drum, 484 lbs. charge, 12 revolutions per minute—Italy ... ..	1·5 to 2
Sorting-frame—Germany, Russia, etc. ... ..	1
Fan for drying-house, 108 to 166 square feet surface of the table—France ... ..	2
Dusting-reel, 12 revolutions per minute, 16 cwt. charge in 10 hours—Italy ... ..	1

The cost of production varies with the kind of powder, the prices of materials, the wages, and the other items usually taken

into account in making such calculations. Since they differ in various countries, it is not necessary to consider them at length. In modern times the cost of manufacture has been considerably reduced by increasing the output of the machines and the size of the plants.

Exact data on the consumption of gunpowder cannot be given, as the statistics available are very small; but the following on the consumption of ammunition in the wars of 1815, 1864, 1866, and 1870-71, may be of interest:—

In the war of 1815 the Prussian artillery had 285 guns, and the maximum number of shots made by any one gun during the whole war was 160·83. The total number of shots was 18,018, and they required 1480 (German) cwt. 96·4 lbs. of shot, and 431 cwt. 34·5 lbs. of powder.

In the war of 1864, in the Elbe duchy, Prussia fired a total of 543,484 cartridges.

In the war of 1866, in Bohemia and on the Main, 268,000 men (infantry) used altogether, including lost and spoiled ones, only 1,843,536 cartridges, so that the average consumption in the whole army was only seven cartridges per rifle.

According to official statistics, the Prussian artillery, including the 14th Baden Regiment and the Hessian contingent, in the war of 1870-71, with 1344 guns, fired altogether 267,975 shots—the average for a gun was therefore 199 shots. The Bavarian artillery made 56,211 shots with 216 guns—an average of 260 shots per gun. Saxony had 16 batteries, and made 15,521 shots.

It cannot be estimated, even approximately, how large the consumption of ammunition will be in a future war. The Maxim machine-gun fires 600 shots per minute, and magazine rifles 20 and more; and although such a great consumption of ammunition will only take place in case of need, yet with the long range of modern weapons the tendency to fire at long ranges has to be reckoned with, and much ammunition will probably be wasted.

It cannot be ascertained for want of reliable data what quantities of powder are used in civil engineering and privately, or in those countries where there are no powder factories.

The importation and exportation of Great Britain in the year 1893 was as follows:—

	QUANTITY.	VALUE.
Importation ... ..	1836 cwt.	£13,590
Exportation ... ..	68,593 „	£194,402

## CHAPTER VII

### PROPERTIES OF BLACK POWDER

IMMEDIATELY after the finished powder has been blended, an examination of its properties is usually made, and from time to time the stocks are also re-examined. The examination includes both the physical and chemical properties of the powder.

#### 1. PHYSICAL PROPERTIES.

##### (a) EXTERNAL CONDITION.

Good black powder should have a perfectly uniform slate colour. If the colour is bluish or quite black, the powder contains too much charcoal or is too damp.

To the naked eye, or through a magnifying-glass, the powder should not show any difference of colour when crushed; and it should not be possible to feel any sharp particles. The diversity of colour indicates unequal mixture, and the presence of sharp particles insufficient pulverization of the ingredients. Single bright points, or bluish-white spots, show that the saltpetre has effloresced during drying, which will have also disturbed the uniform mixture. Powders made with red charcoal are of a brownish-black colour. The powder must not give off colour when allowed to run over the hand or a sheet of paper, which would indicate that the powder contained too much moisture or a certain amount of meal powder. The presence of the latter can be detected by sifting the powder on a dusting-reel.

Prismatic powder should have a smooth surface; all the angles should be sharp and complete, and the prisms should not crumble or give off much colour when rubbed.

## (b) SOLIDITY OF GRAIN.

On pressing powder by hand it should not crackle, and it should not be easily crushed on the hand by the pressure of a finger. At the same time, it should not fall to dust at once, but should first split up into angular splinters.

In Germany, in order to test the solidity of the grain, 1·1 lbs. of powder are put into a leather bag, and this is put into a glazing-drum which is rotated for a quarter of an hour at 15 revolutions per minute, after which the loss of weight must be not more than 1·55 per cent. In France, an average of various samples is taken, and after this has been dusted exactly 8 kilogrammes (17·6 lbs.) are weighed, and put into a barrel holding 12 kilogrammes (26·4 lbs.). This barrel is placed in a second corresponding barrel, and the whole is then allowed to run down an incline of 15 degrees and 5 metres (16 feet  $4\frac{3}{4}$  inches) in length. The incline is made of planks, and, at a distance of a metre apart, there are cross-strips,  $1\frac{1}{4}$  inches high, of hard-wood. At the end of the incline a mattress of hay is placed to stop the barrel. At the side of it there is a second incline made in the same way, but falling in the opposite direction. The barrel is allowed to roll down one incline and then back again on the other, and this is repeated a hundred times on each incline, so that the barrel has altogether travelled 1000 metres. The powder is then dusted. The remaining grains are weighed, when the loss in weight should not exceed 0·20 per cent.

## (c) SIZE OF GRAINS.

The grains must be of the prescribed size and, as far as possible, of the same thickness. In France, it is further specified that the number of grains per gramme should be within certain definite limits separately fixed for each kind of powder.

The examination for size in Prussia is done on the classifying apparatus described on p. 234. Two and a half kilogrammes ( $5\frac{1}{2}$  lbs.) of powder are put on the sieve, and 100 double strokes given to it. Altogether the sorting apparatus contains six frames, the uppermost of which has a cover, and the lowest one a tray underneath. The first sieve has holes of 1·3 millimetres ( $\frac{1}{25}$  inch), the second 1·2 millimetres ( $\frac{1}{21}$  inch), and the third 0·68 millimetre ( $\frac{1}{37}$  inch) wide, and the fourth one is a hair-sieve. The grains

held in the meshes of the sieve are considered as having fallen on to the sieve immediately below. With cannon powder no hair-sieve is used. Large-grained powder is examined in a sorting-reel covered with wire gauze of 4 and 10 millimetres ( $\frac{5}{32}$  and  $\frac{5}{16}$  inch) mesh. With rifle powder none must remain on the first sieve, 5 per cent. at most on the second, 65 per cent. on the third, 50 per cent. on the fourth, and 8 per cent. at most on the lowest one. With cannon powder no powder must be retained on the first sieve, not more than 5 per cent. on the second, and not more than 10 per cent. on the lowest one. With large-grained powder not more than 1 per cent. must fall through the 4 millimetre ( $\frac{5}{32}$  inch) sieve, and not more than 4 per cent. fall out at the end over the 10 millimetre ( $\frac{5}{16}$  inch) sieve.

Prismatic powder is measured for exact size by standard gauges, the holes being measured in the same way. The prisms are put into a frame equal in size and shape to the boxes in which they are packed, in order to see whether the proper number can be packed in the ordinary-sized case. The examination of the size of grains is conducted in a similar manner in all other countries.

#### (d) DENSITY.

Three kinds of density of black powder are recognized—

- (1) The gravimetric density, or volumetric weight in air.
- (2) The relative density, or real specific gravity.
- (3) The absolute specific gravity.

The gravimetric density is the weight of the grains of powder, including the air between them contained in unit volume. The relative or true density is the weight of the grains excluding the air contained between them, but including that contained in the pores of the grains. The absolute density is the weight of powder with the exclusion of all atmospheric air.

##### (a) *The Gravimetric Density.*

The gravimetric density of powder is found by determining the space which a quantity of powder of a certain weight occupies; or inversely, by determining the weight of a given quantity of powder filling a certain space. In practice, the latter method is used.

The various apparatus for determining the gravimetric density do not give uniform results. The exactitude of measuring depends both on the shape of the vessel and the height from

which the powder falls into the measuring vessel, and also on the size and shape of the grains and on the shape and diameter of the filling-hole. These circumstances are well known to everybody who ever tried to fill a measuring vessel with granulated matter.

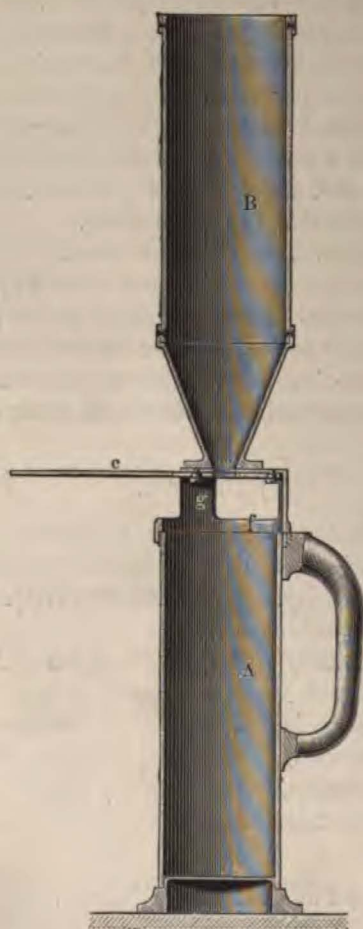

FIG. 137.

Comparisons, therefore, can only be made by measuring the same kinds of powder in the same apparatus.

In Great Britain, the "air space" is taken, *i. e.* the space (in cubic inches) occupied by a pound of powder; but the general way of determining the gravimetric density is by means of a



litre measure (Fig. 137). It consists of a measuring vessel (A), made of brass or copper, 77 millimetres ( $3\frac{1}{2}$  inches) wide and 215 millimetres ( $10\frac{7}{8}$  inches) high, which is provided with a handle, and holds exactly one litre. On this is placed a funnel (B), the cylindrical part of which is 77 millimetres ( $3\frac{1}{2}$  inches) diameter and 205 millimetres ( $10\frac{1}{8}$  inches) high. The conical part is 90 millimetres ( $3\frac{5}{8}$  inches) high, its upper diameter 77 millimetres ( $3\frac{1}{2}$  inches), and its lower one 14 millimetres ( $\frac{3}{4}$  inch), this being also the diameter of the discharging-hole. The funnel rests on a stand consisting of a perforated plate with three feet (g) riveted on to a ring (f). The ring is placed on to the litre measure, and has a slot fitting over the handle. The stand is provided with a cut-off plate (c) turning round a pin, and has on one side a circular opening 14 millimetres ( $\frac{3}{4}$  inch) diameter. The distance between the discharging-hole and the upper edge of the litre measure is exactly 40 millimetres ( $1\frac{3}{4}$  inches). To determine the gravimetric density, the empty litre measure is first weighed exactly, then placed on a horizontal table and the funnel filled with powder, the cut-off plate having been previously closed. The latter is then carefully opened and the powder allowed to run slowly into the litre measure until the grains begin to run over the edge of the ring. This is then closed, the funnel carefully lifted off, and the powder slowly smoothed off by means of a brass straight-edge. A few light blows are struck on to the litre measure to cause the powder to settle a little, and the grains adhering to the edge of the measure brushed off with a soft brush. The whole vessel is then weighed. The difference between the two weighings is the weight of the powder contained in one litre. As a rule, three determinations are made and the average taken.

The cubical weight must be—

In Germany—For rifle powder ... ..	between	0.905	and	0.925
For cannon powder ... ..	„	0.915	„	0.935
For large-grained powder ... ..	„	0.960	„	0.980
Austria—For large-grained powder ... ..	„	0.907	„	0.951
France—Muzzle-loading guns and musket powder ... ..	„	0.830	„	0.870
M. C. 30 powder (muzzle-loading guns and shells) ... ..	„	0.900	„	0.920
C. 1 powder (field-guns), S. P. 1, S. P. 2, S. P. 3 (siege and fortification guns) ... ..	„	0.900	„	0.920

France—Mine powder	... ..	between 0·940 and 0·950
Fuse powder	... ..	0·825
Exportation powder	... ..	between 0·870 and 0·970
Sporting powder	... ..	at least 0·860
Switzerland—No. 4 powder (rifle powder)	... ..	between 0·955 ,, 0·975
No. 5 powder (for lead-coated bullets and shells)	... ..	,, 0·980 ,, 1·000
Cannon powder	... ..	,, 0·960 ,, 0·970

(β) *The Relative and Absolute Density.*

A great many systems have been tried for determining the relative density. One of the oldest methods seems to have been filling the interstices between the grains with lycopodium. A graduated cylinder was filled to a certain height with finely-powdered lycopodium. After the required volume had been noted, this was carefully poured out of the cylinder and then replaced with an exactly-weighed quantity of powder in such a way that a layer of lycopodium was placed on the top of a small layer of powder, and so on alternately. The density was determined from the increase of volume. This method is necessarily not very exact, since its accuracy depends chiefly on whether the lycopodium is finely grained or in the form of dust, and because there are always losses on filling and emptying the cylinder, whilst the least shaking causes an alteration of the volume. Experiments made with one and the same kind of powder gave differences of density of between 1·30 and 1·92. Results differing still more were obtained when weighing instead of measuring was resorted to, and similar inaccurate results were obtained when other solid substances were used in the place of lycopodium.

In France, the determination of the density was attempted in a saturated solution of saltpetre, but such a solution is not without a dissolving action on the powder itself, the amount varying with the temperature. Liquids, in which the ingredients of the powder were insoluble, were therefore sought for, and a suitable one was found in absolute alcohol. Two methods were used with it.

According to one, alcohol free from water, which was allowed to stand for some time before using in the room in which the determination of weight was to be made, was put into a glass tube provided with a cast-glass base and exactly calibrated and divided into tenths of a cubic centimetre. As a rule, the tube was filled up to 33 cubic centimetres, and after a few minutes' rest, to allow the drops adhering to the side of the tube to run down, the volume

of the alcohol was read off; then about 16 grammes of the powder were poured into the alcohol by means of a glass funnel having as long and wide a neck as possible, and as soon as the last grain had fallen the new volume was read, which gave all data required for calculating the density. The powder examined was previously dried in a water-bath, and placed in a desiccator over sulphuric acid until it had acquired the temperature of the room, and then weighed.

According to another method, which is due to Timmerhans, a cylindrical glass with a ground edge was filled with powder by means of a funnel, the top of the vessel smoothed off with a glass rod, and the weight again determined. The density of the powder could be calculated from the quantity of alcohol displaced after its specific gravity had been taken into account. As this method always required more time than the simple reading in a glass tube, the alcohol had time to drive out air from the pores of the powder, and hence the determination was not accurate; but, on the other hand, the value of the first method—namely, the mere pouring of the powder into a graduated glass tube containing alcohol—is doubtful, since when the powder falls into the alcohol, the latter may splash up on the sides of the glass tube; and, moreover, the soaking of the alcohol into the powder can hardly be avoided. Heeren made experiments in this direction, and found that if the quantity of alcohol used was about 7 per cent. of the weight of the powder, it was completely absorbed within three or four seconds, and consequently the reading of the quantity of alcohol displaced was always too low. If the specific gravity of the powder taken was 1.559, then the 7 per cent. by weight would take almost exactly 14 per cent. of the space, since the specific gravity of alcohol at 15° C. is 0.7939; consequently the quantity of alcohol displaced would have to be increased by one-sixth, and the density of the powder would be less.

A necessary consequence of the alcohol entering the powder will be that air-bubbles will escape from the grains, and this will be quicker with porous and unglazed powders than with tough and glazed ones. The latter will, therefore, displace comparatively more alcohol than the former, and the difference between tough and porous, and between glazed and unglazed, powders will appear smaller than they are in reality. With non-porous and unglazed powders the absorption of alcohol, according to Heeren, takes place with such rapidity that the pores are already filled to a great extent with alcohol during the short time of filling,

and that instead of an extremely low density, an extremely high one is obtained, as will be seen from the following experiments:—

Finely-crushed cannon powder was moistened with 8 per cent. of water and made into a cake by a slight pressure. The real density of this cake was found by Heeren's method, which is described below, to be 1.32. When the cake was examined by the ordinary method of filling described above, the density was found to be 1.81. Another cake, which was more highly pressed and had a real density of 1.53, gave, according to the above method of filling, the density of 1.75. It will be seen, therefore, that in both determinations the density found by this method deviates considerably from the true one, but more so with a very porous powder than with a less porous one; and that the more porous powder even showed a greater density (1.81) than the tougher powder (1.75). The looser, therefore, the powder is in texture, the more nearly will the relative density approach to the absolute density, which, on an average, can be taken to be 2.00.

With regard to this method a very peculiar property, which was observed by Heeren and General Otto, may be mentioned. If powder is poured into alcohol, the alcohol rises after a few seconds, according to Heeren, up to one-third of the volume of the powder, and after an hour it will fall again—without, however, reaching the former level. During the rise of alcohol a quantity of bubbles form, and, according to Otto, at the same time an increase of the temperature of the alcohol of nearly  $2\frac{1}{4}^{\circ}$  F. takes place. Experiments made by Dr. Upmann with large-grained powder show that the increase of temperature differs according to whether the ball of the thermometer only touches the surface of the powder or is entirely surrounded by it. In the first case, an increase of temperature of  $1\frac{1}{4}^{\circ}$  F. takes place after one or two minutes; whilst, in the latter case, the thermometer rose  $2\frac{1}{2}^{\circ}$  F., and fell again  $1\frac{1}{3}^{\circ}$  F. after twenty minutes.

However interesting this phenomenon may be, it is difficult to find a correct explanation in the facts so far observed. The appearance of a quantity of bubbles on pouring the powder into the alcohol is very peculiar. It is more than improbable that they escape from the alcohol, and therefore only the powder can be considered as their source. If these bubbles consisted of ordinary air adhering externally to the grains, then the level of alcohol ought to fall and not to rise, and the same would take place if the alcohol entered the pores of the powder and displaced the air which it contained. If, therefore, ordinary atmospheric air

is excluded, the question arises whether these bubbles do not consist of compressed air; since charcoal, as is well known, has the property of absorbing gases and condensing atmospheric air in its pores. On adding alcohol, the condensed air would be gradually displaced by it, and after some time air of ordinary density would remain in the pores. Against this supposition must be put the circumstance that, according to Heeren, this peculiar effect also occurs in quite as marked a way when the powder has been freed from enclosed air by being exposed while warm under the receiver of a vacuum pump, and as the condensation of gases by charcoal is only gradual, the powder could not in the short interval between its removal from the air-pump and the making of the experiment immediately afterwards absorb any considerable quantity of air. Similar results would be obtained if the bubbles escaping were considered as hydrogen gas. The increase of volume could be explained by the increase of temperature which takes place on the contact of alcohol with charcoal and sulphur. If charcoal, or sulphur, is moistened with alcohol, a rise of temperature takes place. According to Pouillet, it is  $1.270^{\circ}$  C. for charcoal, and  $0.173^{\circ}$  C. for sulphur; so that if both exist in equal weights in the powder, an increase of temperature of  $1.443^{\circ}$  C. would take place. This behaviour of charcoal and sulphur with alcohol does not yet give a sufficient explanation for the considerable rise of the alcohol, since alcohol of 0.80 specific gravity (at  $12.5^{\circ}$  C.) only expands between  $10^{\circ}$  and  $15^{\circ}$  C. for every  $1.25^{\circ}$  C. increase by 0.001313 of the volume occupied by the alcohol at  $10^{\circ}$  C. That the volume of the alcohol always remains a little higher than at the beginning may be caused by absorption of moisture.

As previously mentioned, the method of pouring powder into alcohol is not free from errors, and Heeren therefore tried to improve upon it. A glass capable of holding 33 grammes of water, and fitted with a ground-in stopper provided with a groove on one side, is taken, and its weight when filled with absolute alcohol at  $21.25^{\circ}$  C., determined once for all. The powder is heated in a short, wide glass tube, or in a small porcelain crucible, for some time on a sand-bath at between  $50^{\circ}$  and  $62^{\circ}$  C. This is then put for some time into a basin filled with hot sand under an air-pump, then rapidly weighed, and poured into the above-mentioned glass, which is half filled with alcohol. This is now put under the receiver of the air-pump, and the pumping continued as long as the air-bubbles continue to escape from the grains. The alcohol boils under this process, and consequently large bubbles are formed

by it, but they can be easily distinguished from the small air-bubbles. When all air has been eliminated from the powder, it is left to itself for about another hour, so that the alcohol can enter the pores from all sides; then the glass is filled up to the top with alcohol, the stopper inserted, and the glass is placed or hung for about an hour in a vessel filled with water at a temperature of  $21.25^{\circ}$  C. After this the glass is taken out, and should there still be some air-bubbles in it, a little alcohol is added; then after its surface has been quickly wiped the glass is weighed. The alcohol is now poured off as completely as possible, and the powder put on to a double piece of filter paper, on which it is turned by means of a knife until it is no longer wet, but still very moist. Then it is emptied into a small cylindrical glass, the upper edge of which is ground, so that it can be closed by means of a glass plate. In order to remove the alcohol still adhering externally to the powder, a strip of filter paper is cut of such a width that it can be comfortably brought into the glass; this is then closed with the thumb—or better, with a glass plate—and shaken until the powder appears to be just dry externally. This can be recognized partly by a magnifying-glass and partly by the grains no longer adhering to the sides of the glass or to the paper. As soon as this occurs the powder, which is still permeated with alcohol, is weighed, and all data for calculating the specific gravity of the powder with and without regard to the pores are obtained. Let

(*a*) be the weight of the glass filled with alcohol;

(*b*) the weight of the dried powder;

(*c*) the weight of the powder saturated with alcohol; and

(*d*) the weight of the glass with alcohol and saturated powder;

then the density in relation to the alcohol (*x*) is found by the formula  $x = \frac{b}{a+c-d}$ , and the specific gravity in relation to water

(*x*<sub>1</sub>) is found by the formula  $x_1 = \frac{bc}{a+c-d}$ , wherein *c* is the specific gravity of the alcohol.

According to experiments carried out by Heeren himself, one particular kind of powder gave the following results:—

SPECIFIC GRAVITY OF GRAINS INCLUDING THE PORES.			OF THE MASS OF POWDER WITH EXCLUSION OF THE PORES.
(1)	1.523	...	1.969
(2)	1.526	...	1.983
(3)	1.524	...	1.972
(4)	1.529	...	1.969
(5)	1.534	...	1.986
Average			1.976

therefore the pores occupied 22·7 per cent. of the space of the grains.

The same kind of powder, examined by a careful and clever manipulator at Spandau, gave an average relative density from five determinations of 1·5592.

Since this method takes a good deal of time, Heeren proposed a shorter method, which can be used where the same proportions are always maintained, as, for instance, in Government factories.

The absolute density will always be the same; therefore, when it has been determined once for all, the method becomes very simple, it being only necessary to saturate a weighed quantity of powder with alcohol by Heeren's method described above, and then to determine the increase in weight so caused.

The relative density  $X_1$  of the powder is given by the formula

$$X_1 = \frac{b \cdot e \cdot g}{b \cdot e + g \cdot f},$$

when  $b$  will be the weight of the dry powder;  $e$ , the specific gravity of alcohol;  $f$ , the increase in weight of the powder by saturating it with alcohol;  $g$ , the absolute density of the powder which is supposed to be known. Suppose the weight of the dried sample powder ( $b$ ), 5 grammes; its weight, after saturation with alcohol ( $b+f$ ), 5·94 grammes; thus the increase of weight ( $f$ ), 0·94 gramme; the density of the powder ( $g$ ), 2·01 grammes; and the specific gravity of alcohol ( $e$ ), 0·794 gramme; then the relative density of the powder is

$$X_1 = \frac{5 \times 0 \cdot 794 \times 2 \cdot 01}{5 \times 0 \cdot 794 + 2 \cdot 01 \times 0 \cdot 94} = 1 \cdot 36.$$

In order to test the accuracy of this method, Heeren made the following experiment:—Cannon powder was finely crushed, moistened with 8 per cent. of water, compressed in an iron mould, and then dried. A piece of this was weighed, and, after having been heated gently, it was brushed over with melted stearine. The gravimetric density determined in the usual way in water was 1·470. Another piece of the same cake was then broken to the size of cannon powder, freed from dust, and the density determined by the saturation method. It was found to be 1·480 in one case, and 1·455 in another; or an average of 1·467. With a more highly-compressed powder-cake, the density in water when its surface was coated with shellac varnish was found to be 1·579; by the saturation method in one determination, 1·572; and, in another, 1·580; giving an average of 1·576.

If these figures are compared with those mentioned on page 292, it is evident that a near approach has been made to solving the



problem of exactly determining the density. Heeren himself demonstrated how much more trustworthy his method is than that of quickly filling by subjecting the cake just mentioned (the density of which after coating with stearine was 1·470, and by the saturation method 1·467) to the method of quick-filling, with which he obtained a density of 1·657. The other cake, with a density of 1·579, gave, in two determinations by the saturation method, 1·580 and 1·572; and, by the method of quick-filling, 1·746. Its superiority is further proved by the following figures:—

	SATURATION METHOD.	QUICK-FILLING METHOD.
Cannon powder, from Waltham Abbey, made 28th February, 1850 ... ..	1·556	1·715
The same, but of older manufacture ... ..	1·524	1·617
Cannon powder, from Bomlitz in Hanover ... ..	1·401	1·568
Cannon powder, from Aerzen in Hanover ... ..	1·470	1·520
Cannon powder, made by Champy's method, from an unknown factory ... ..	1·440	1·568

In order to make clear the degree of density of these powders, Heeren calculated the ratio of the volume of the pores filled with air to the total volume of the grains. Assuming the latter to be 100, he found the following values:—

For cannon powder of Waltham Abbey, made 28th February, 1850 ... ..	22·6 : 100
The same, but of older manufacture ... ..	24·1 : 100
Cannon powder, from Bomlitz in Hanover ... ..	30·3 : 100
Cannon powder, from Aerzen in Hanover ... ..	26·9 : 100
Champy's powder ... ..	28·3 : 100

The differences are still more apparent if the ratio between air space and solid substance is considered. This is shown in the following table:—

Cannon powder, from Waltham Abbey, made 28th Feb- ruary, 1850 ... ..	29·2 : 100
The same, older manufacture ... ..	31·8 : 100
Cannon powder, from Bomlitz in Hanover ... ..	43·4 : 100
Cannon powder, from Aerzen ... ..	36·8 : 100
* Champy's powder ... ..	39·4 : 100

Besides this method, replacing the alcohol by oil of turpentine and fine oils has also been tried, but without, however, obtaining the same accuracy as with Heeren's method.

Another process proposed by General Otto for determining the relative specific gravity of powder-cake is notable on account of its giving results still more accurate than Heeren's method. It

consists essentially in coating the cake with a material which does not wet the powder-cake, on the one hand, and which, on the other, allows an exact determination of the weight and volume of the cake. After a series of experiments, collodion was found to be the most suitable material to use as a coating. A determination by this method is made as follows:—

The piece of cake about to be examined is carefully weighed and then coated with collodion. If the coated cake is then weighed in air, the weight of the collodion coating is given by the difference between the two weights. After weighing the cake in water, the density of the uncoated piece of cake can be found. The following points in the manipulations should be noted:—

In order to cover the cake with a waterproof coating, the former should be quite dry when weighed, then warmed and brushed over twenty times with collodion, to which a little varnish has been added; 10 drops of varnish to 8 grammes of collodion as sold by chemists are the proportions. Each coating must be allowed to dry before a second one is applied, but the cake must on no account be warmed to facilitate drying, because the air, being prevented from escaping by the coating, would expand by the heat and swell the coating, and also cause blisters in it, which would quite destroy the accuracy of the method. Varnish is added to cause the coating to adhere more intimately, and to prevent the formation of cracks which would allow water to find its way in the pores when weighing under water. As soon as the cake is in this manner properly coated with collodion, it is again weighed in air and then in water. If  $P$  be the weight before coating is applied,  $P_1$  the weight in air after coating,  $Q_1$  the weight under water, then, if the unknown weight under water of the uncoated cake be  $Q$ , the unknown loss of weight which the uncoated cake would have undergone on weighing under water will be  $P - Q$ , and

$$P - Q = P_1 - Q_1 - \frac{P_1 - P}{S}$$

in which  $S$  is the specific gravity of the collodion coating. The density ( $G$ ) of the cake will therefore be

$$G = \frac{P}{P - Q}$$

To determine the specific gravity of the collodion coating, Otto took a dull-ground glass plate and weighed it carefully in the air and under water. The plate was then carefully dried, and, as described above for the powder-cake, was coated twenty times with collodion. When the coating was sufficiently dry, the glass plate was again weighed in air and under water. Calling the weights

of the uncoated plate in air and water  $L$  and  $W$  respectively, and those of the coated plate  $L_1$  and  $W_1$ , then  $L_1 - L$  will be the weight of the collodion coating, and  $L_1 - L - (W_1 - W)$  will be the apparent loss in weight of collodion on weighing under water; the specific gravity of the collodion coating will therefore be

$$S = \frac{L_1 - L}{L_1 - L - (W_1 - W)}$$

A few examples are given below to show the accuracy of this method. The experiments were made with a carefully-selected piece of cake, which was divided into twelve parts.

DESIGNATION OF THE PIECES OF POWDER-CAKE.	WEIGHT				LOSS OF WEIGHT UNDER WATER OF THE COATED POWDER-CAKE.	SPECIFIC GRAVITY.
	Not coated. In air.	Coated. In air.	Of the coating.	Coated. Under water.		
	Grammes.					
1	13.695	13.974	0.279	5.393	8.581	1.63930
2	15.056	15.374	0.318	5.939	9.435	1.64072
3	14.393	14.676	0.283	5.672	9.004	1.64043
4	14.358	14.666	0.308	5.639	9.027	1.63594
5	14.167	14.571	0.404	5.590	8.981	1.63732
6	15.076	15.397	0.321	5.955	9.442	1.64208
	Average					1.63930

The specific gravity of the collodion coating was 1.23. The experiments were carried out on November 5, 1857, and repeated on December 2, 1857, with the same pieces. After the weighing in water the pieces were carefully dried, their density determined in a graduated tube by dipping them into alcohol, and after the collodion coating had been carefully removed the density was again determined in alcohol. The results of these experiments are given in the following table, and, for comparison, the results obtained on November 5 are put in the first column:—

DESIGNATION OF THE PIECES OF POWDER-CAKE.	SPECIFIC GRAVITY FOUND			
	By hydrostatic weighing in distilled water by applying a collodion coating		By using the graduated glass-tube with alcohol	
	On the 5th November, 1857.	Simple repeating on the 2nd December, 1857.	with the	after taking off the
			collodion coating.	
1	1.63930	1.63923	1.65862	1.6418
2	1.64072	1.64179	1.62437	1.6945
3	1.64043	1.64133	1.62635	1.6774
4	1.63594	1.63670	1.63980	1.6284
5	1.63732	1.63888	1.63315	1.7225
6	1.64208	1.64298	1.62695	1.6574
Average ...	1.63930	1.64015	1.63487	1.67032

As will be seen from the table, the average densities as found on the two days weighing under water differ from each other by 0.00085—a difference which is so insignificant that, as far as the powder-cake is concerned, this method can be considered as perfectly trustworthy and accurate. The fact that the density is a little less than that found by the method of filling (third column) may be due to adhesion of the alcohol to the walls of the glass—at least no other plausible explanation can be readily found.

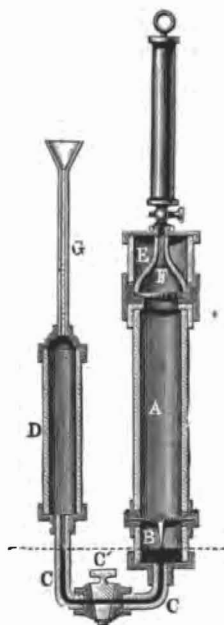

FIG. 138.

On account of its great accuracy, this method could well be used to determine the density of prismatic powder if, apart from the difficulty of carrying it out, the whole method did not occasion so much loss of time.

Quicker results are obtained by apparatus with mercury as the liquid. Such apparatus are:—

1. *MARCHAND'S DENSIMETER* (Fig. 138).

A cylinder (A) which holds the powder to be examined is closed at its lower end with a fine iron sieve, the holes in which

are too small for the powder to fall through. The sieve is firmly screwed to A, and has a fine ivory point going downwards into the small cylinder (B), which is screwed on to A. B is connected with a graduated cylinder (D) by means of the tube (C), which is fitted with a steel tap ( $C_1$ ). A calibrated glass tube (G), divided into tenths of a cubic centimetre in such a manner that one-fiftieth of a cubic centimetre can still be comfortably read off, is screwed on to the upper part of D. The upper part of A has a fitting screwed on, in which the short cylinder (E) is fixed. This communicates with A by means of the glass tube (F), which is wide at the bottom and very narrow at the top. It has a fine horizontal line as an index. A thin plate of box-wood, or a disc of soft leather, is fixed between the tube (F) and the cylinder (A). A hand air-pump screws on to the cylinder (E), and all screw-joints should be air-tight. Mercury is poured into B through the tube (G) until its surface just touches the ivory point; more mercury is then run from an exactly-measured quantity through G until the cylinder (A) is filled by the suction of the air-pump exactly to the index-line in the tube (F) and the mercury in C occupies the same level as when first filled up to the ivory point. In this way the capacity of A, and that part of B which is above the ivory point, is determined. After this the tap ( $C_1$ ) is closed, and exactly the same quantity of mercury poured through G into D. D, being smaller than A, cannot take the whole quantity of mercury, so that a small part remains in G. The level of mercury in G is carefully noted. After this E is screwed off from A, and after the mercury has been poured out, so much powder is put on to the sieve that the whole of the cylinder (A) is nearly full; then the apparatus is screwed together, mercury is poured through G exactly up to the ivory point, and on to this the necessary quantity of mercury, which has been previously determined to fill the cylinder (A). The mercury is then drawn up slowly, by means of the air-pump, to the index-mark in F, and the difference between the then level of the mercury in G, and that previously noted, is taken. This gives the difference between the volume of the powder and the volume of the mercury used.

This method was not used for long, because the apparatus is composed of so many parts, and is too fragile on account of the length of the tube (G). If the difference of level in the mercury is to be at all easily distinguishable, then at least 33 grammes of powder must be examined. The accuracy of the results depends

upon twice bringing the mercury in each determination exactly to the level of the ivory point in B, and upon twice measuring the same quantity of mercury into a vessel independent of the apparatus. These difficulties of manipulation are increased by the fact that the mercury does not by any means fill all the interstices between the grains. This is explained by the viscosity of the mercury and by the air being only eliminated by rarefaction, and that at the same time the air in the pores of the grains is also subjected to the same rarefaction. If the mercury rapidly enters the interstices between the grains, then, after the least rarefaction, it may happen that, in consequence of this, air may get out of the pores of the lowest layers of powder, only after the grains have already been surrounded by mercury. Since the air cannot then escape entirely, on account of the mercury column over it, the mercury will pass afterwards round those grains.

Quite erroneous results were obtained when, in order to determine the volume of powder, Boyle's law was made use of, and Kopp's "Volumenometer" and Say's "Stereometer" tried for the purpose. The two apparatus are well known, and it may be sufficient to refer to the original papers, 'Annalen der Chemie und Pharmacie,' vol. xxxv., and 'Annales de Chimie par Guyton-Lavoisier,' vol. xxiii., 1797. According to Kopp's method, it is intended to find the volume from the compressed air; according to Say's method, from rarefied air; but the density of the powder cannot be determined, because air also has to be considered which unavoidably fills the pores of the grains, and therefore the pores cannot be taken as existing, so that the results obtained with this apparatus only show the atomic weight of the proportions of the various kinds of powder. Thus, for instance, powders of the same composition, showing a specific gravity in alcohol of 1.56, 1.77, 1.67, 1.82, respectively, gave always the same density in these apparatus, in Kopp's "Volumenometer," 2.704 or 2.499; in Say's "Stereometer," 2.441. Similar results were obtained when Regnault's "Volumenometer" and Leslie's "Stereometer" were used.

## 2. HOFFMANN'S DENSIMETER.

In order to avoid the difficulties of direct determination, Captain Hoffmann constructed an apparatus for measuring the porosity, and thus determining the density of the powder.

On to a metal plate (A), divided into Parisian lines from top to bottom (Fig. 139), and standing firmly on a base (B), two long arms (C and C') or two bent glass tubes of about  $\frac{3}{4}$  inch in

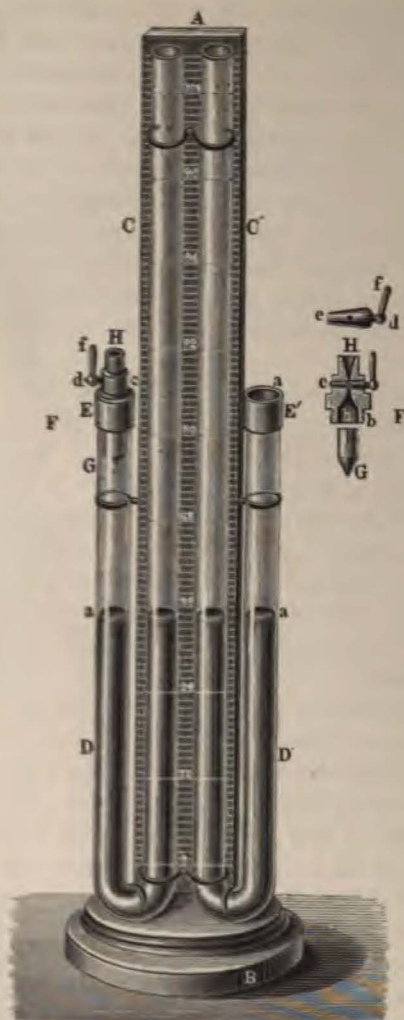

FIG. 139.

diameter are fixed. The short branches (D and D') are each provided with a steel ring (E and E'), and fitted with nuts and screws by means of which the steel fittings (E, E') can be connected



with D and D', so that the hollow steel cylinder (G) penetrates into D and D', whilst the part (H) projecting above (D and D') closes them air-tight. The perforation through H, continued through the thick part (c) of these steel fittings, is closed at h by a piece of very fine wire gauze. At the same time, this thicker part (c) is perforated horizontally, and the plug (d) can move air-tight in the perforation. According to whether, therefore, the vertical perforation (e) is connected with or shut off from the inside of D and D' (for which purpose the small lever (f) serves), the admission of air into D and D' can be brought about or prevented. G is only held by the friction of its upper ring in b, which is slotted in four places, and can be easily fixed or removed. Mercury is poured into the glass tubes up to about a—a. The two cylinders (G) have in their pointed ends fine holes which allow the mercury to enter, but prevent even the smallest grains of powder from falling through. They are

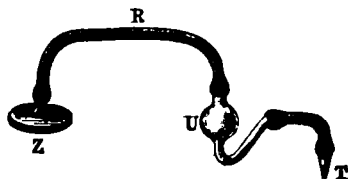

FIG. 140.

filled with two different kinds of powder, and then the quantity taken up by each is weighed, after which the two fittings (E, E') are screwed into D and D'. An india-rubber tube (R, Fig. 140) is in connection with the interior of D and D' by means of a steel point (T), inserted air-tight into H, and by means of plates (Z) with an air-pump. The air is exhausted from above the mercury, and the latter rises into D and D', filling the interstices between the powder grains in G. As soon as this is effected—that is to say, as soon as the mercury comes up in the small glass tube (U, Fig. 140)—the air is shut off by means of the tap (d), the india-rubber tube removed from H, the apparatus placed under the bell-glass of an air-pump, and the air exhausted from the long glass tubes. The air contained in the pores of the grains in G expands out of them, and again drives the mercury out of G; this passes back into the short arms of the glass tube, and causes a rise of the mercury in the long arm. If, then, the level of the mercury is read off after the

interstices between the grains in G have been filled with mercury, and again after the mercury has completely receded, then the pressure against the mercury or the quantity of air enclosed in the pores of the grains is shown. In this manner the porosity of two kinds of powder can be determined, at least comparatively if not in absolute measure. If the difference of level of the mercury readings with powder No. 1, of which ( $g$ ) grammes were weighed, is  $=r$ , and that of powder No. 2 of which ( $g_1$ ) grammes were taken  $=t$ , then the porosity of No. 1, in relation to that of No. 2, is

$$p = \frac{r}{g} : \frac{t}{g_1}.$$

In this case mercury is the agent used for filling the interstices between the powder grains. The inapplicability of mercury for this purpose was already pointed out when Marchand's method was described. A further disadvantage is that the mercury, on rising, only partially fills the interstices between the grains, and does not completely recede, so that the results become unequal.

In general the method, even when allowance is made for all possible sources of error, is not suitable for determining the density of powder, because only relative figures are obtained, which show that one of the powders examined is more porous than the other; but the principal information required, namely, how much greater the porosity of one kind is than that of the other, is not given.

### 3. BODE'S DENSIMETER (Fig. 141).

This is chiefly used for determining the density of large-grained and prismatic powder. The apparatus consists of a base plate (A) with standard (B), and a movable bracket (C), carrying a glass vessel (D), into which the framework of a scale (c) dips. The upper rim of D is ground off, and it is made of stout glass in order to stand the pressure of mercury in it. The scale is made of steel, the three arms are connected on the top by a horizontal triangular frame (E), the central boss of which is perforated. Three steel pins (G) are screwed firmly on to the boss. A disc with three perforations, through which the steel pins pass, carries a vertical graduated scale (F), which goes through the hole of the boss, the reading being taken on the upper edge of the disc. The disc is made sufficiently heavy to just float on the mercury. The apparatus is set up perfectly horizontal on a table by means of

of adjusting screws, and the glass filled with chemically pure mercury free from dust. The specific gravity of the mercury is determined either in the ordinary way, or a steel capsule of 217 grammes weight, the specific gravity of which at 13.75° C. is 7.6552, is used. After the temperature of the room has been noted, the steel capsule is put on to the mercury, and the weighed

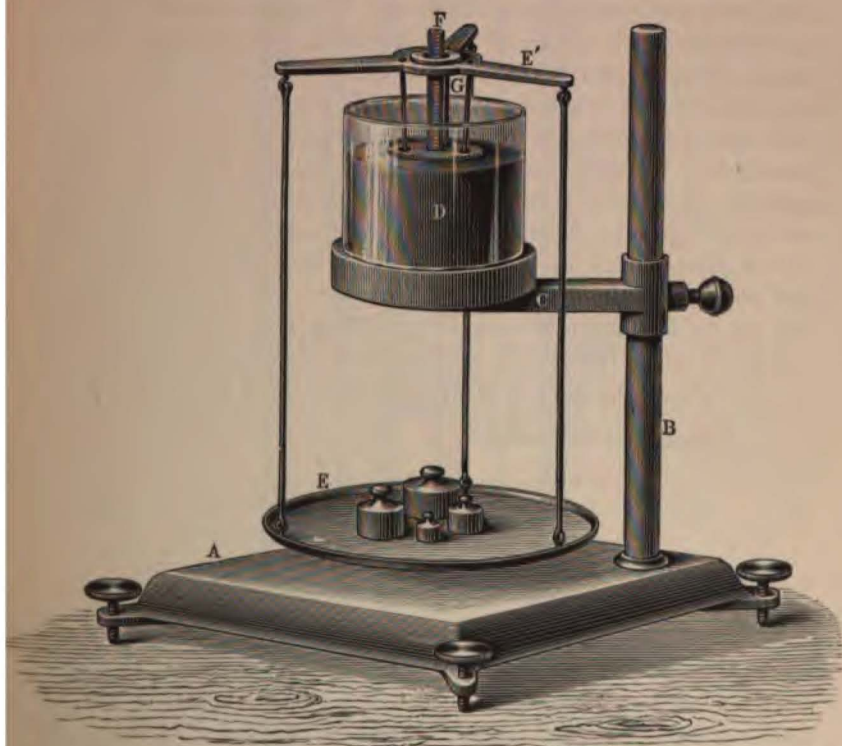

FIG. 141.

scale put on to it. Weights are then placed on the scale until the capsule is pressed so far down that the disc just touches the surface of the mercury. If the weight of the capsule be  $S$ , and its specific gravity  $p$ , the weight of the scale  $W$ , the weights put on to it  $G$ , and the weight of mercury displaced  $Q$ , then  $Q = G + W + S$ . The volume of the steel capsule  $v = \frac{S}{p}$ , and therefore the specific gravity of the mercury

$$P = \frac{Q}{v} = \frac{(G + W + S) p}{S}$$

After the specific gravity of the mercury has been determined, the prismatic powder, which has been carefully freed from all dust by a camel-hair brush, is first weighed on a balance, and then put on to the surface of the mercury. The balance of the apparatus is then carefully placed on it in such a manner that its three suspension rods hang quite free from the glass and the ring of the frame. Care must also be taken that the powder does not touch the walls of the glass. Weights are then put on the balance until all three pins dip into the mercury. Then enough weights are taken off the balance to allow the disc to rise, until it just touches the surface of the mercury. Of course the connecting piece (E) must be horizontal, which can be easily arranged by properly placing the weights on the balance. When equilibrium is established, all the factors are known for calculating the specific gravity of the powder. If the specific gravity of mercury at the temperature of observation is P, the absolute weight of the powder S, the weight of the balance W, and the weights put on to the balance (single grammes are read off on the rod F) G, then the weight of the mass of mercury displaced is  $Q = G + W + S$ , the weight of an equal volume of water  $M = \frac{Q}{P}$  and the density of the powder

$$Z = \frac{S}{M} = \frac{S}{\frac{G+W+S}{P}} = \frac{SP}{G+W+S}$$

#### 4. BODE'S DENSIMETER WITH A MERCURY

AIR-PUMP (Fig. 142).

This apparatus consists of a cylindrical steel vessel (A), which can be closed at the top and bottom by taps (B<sub>1</sub> and B<sub>2</sub>). The vessel is fixed on to a frame (C), and is connected at its lower end by means of an india-rubber tube (c) with the mercury vessel (D). In order that it may be carried more comfortably and safely, the mercury vessel is fitted with small handles (d). The upper frame and the mercury vessel (D) are connected by means of a rope passing over pulleys (e), and thence over a central pulley (f) fitted with a handle and a ratchet and pawl, so that by simply turning the handle the mercury vessel can be lowered, and at the same time, the steel vessel lifted, or *vice versa*, and the steel vessel filled with mercury, or emptied, at will.

In order to determine the specific gravity by this apparatus, the steel cylinder is screwed in position, filled with mercury,

then taken out again, and accurately weighed. The steel cylinder

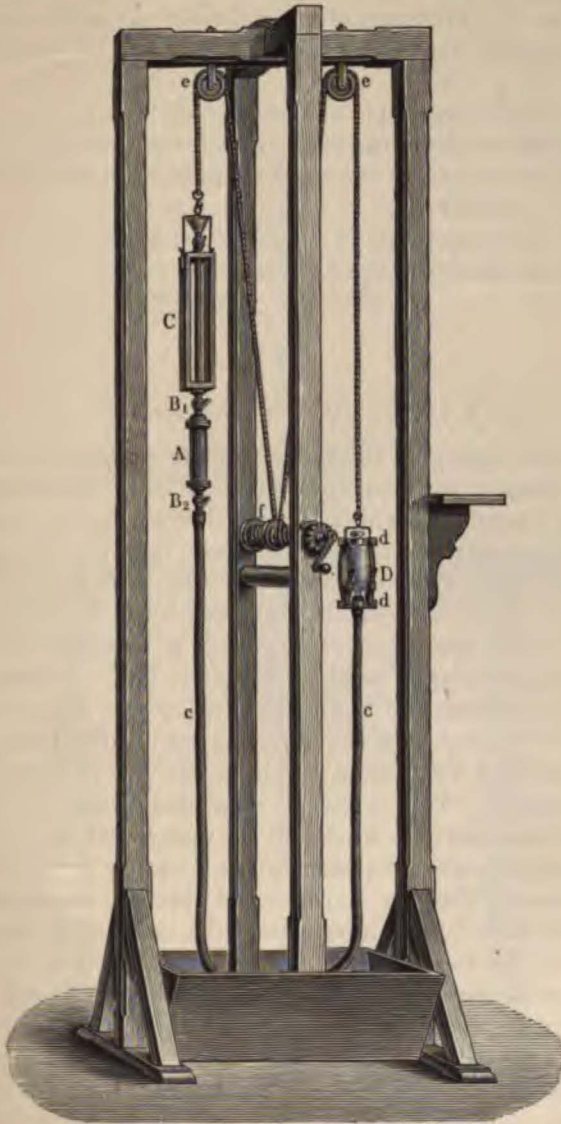

FIG. 142.

is then put back in the upper frame, the mercury discharged, and a weighed quantity of powder passed in through a funnel.

The upper tap is next closed and the lower one opened, the cylinder is filled with mercury, and again weighed. The difference between the two weighings of the cylinder—*i. e.* with and without powder—enables the density of the powder to be calculated. Thus—

Let P be the weight of the powder used ;  
 T the weight of the steel cylinder with the mercury ;  
 T<sub>1</sub> the weight of the steel cylinder with the mercury and powder ;  
 t° the temperature of the mercury ; and  
 S the density of the powder ; then

$$S = \frac{P \cdot 13.59 \cdot (1 - 0.00018 \cdot t^\circ)}{T - T_1 + P}$$

#### 5. RICQ'S DENSIMETER (Fig. 143).

With this apparatus the volume of the powder is determined by comparing it with that of 10 glass balls, which is already accurately known, and which is verified from time to time. The apparatus consists of a cast-iron vessel (A), the upper part of which is a wide cylinder, and the lower part a narrower one. The lower end of the cylinder is closed by a flange (B), which carries a short shaft (b), on to which a bevel-wheel (c), with square boss, carrying a hand-wheel (D), is put. A second bevel-wheel (c<sub>1</sub>) is attached to a nut (E) fitted in the flange (B), which can thus be rotated in either direction by the hand-wheel. The nut gears with a long screw (F), the upper end of which is fitted to a piston (f). This screw is perforated along its axis, and carries an iron pin (G), which on its upper part is also formed into a peculiarly-shaped piston (g), and on the lower end has a short thread. The pin is perforated through its whole length with a fine hole. India-rubber rings (h) are placed between the upper and the lower piston. The lower screw of the pin is provided with a nut (i); by turning this the india-rubber rings are pressed between the pistons, and a tight joint made against the wall of the cylinder. The lowest end of the pin has a knob (i<sub>2</sub>), for the purpose of discharging the mercury from the apparatus. The upper cylinder of the apparatus is closed by means of the disc (J), the joint being made with an india-rubber ring. A screw cover (K), provided with two handles, presses this disc tightly down. A tube passes from the disc through the cover (K), to which a thick graduated glass tube (L) is fixed by means of

putty. A wooden rod (M) passes down the glass tube which has an iron bar, with a disc (m) at its lower end passing through its centre. The upper end of this rod is screwed and fitted with a wing-nut (o). An india-rubber ring (n) is put between

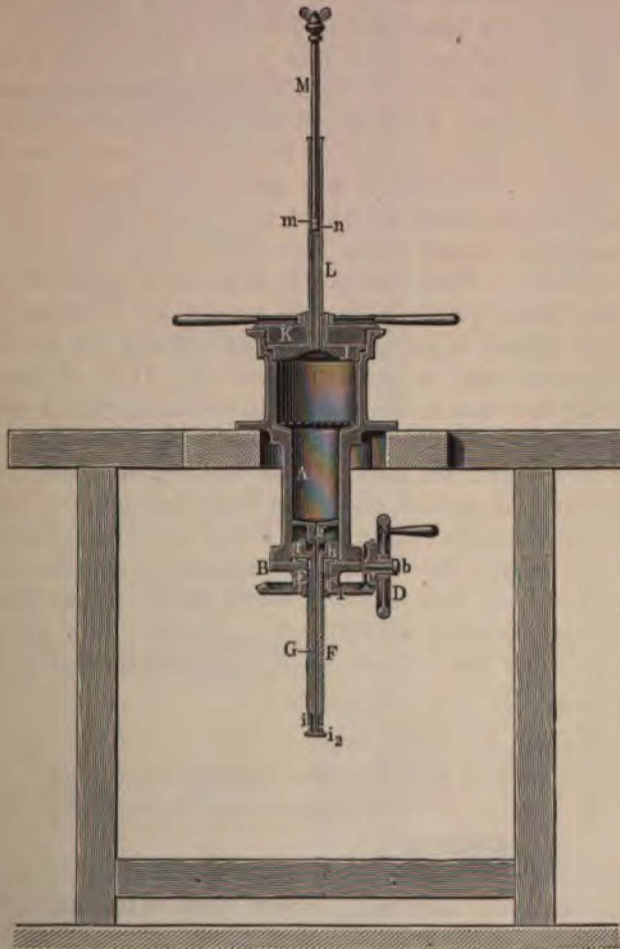

FIG. 143.

the disc on the iron rod and the end of the wooden rod. When the nut (o) is turned, the india-rubber ring is compressed and fits tightly in the glass tube. It must also be noted that the upper cylinder has a sieve on the bottom to keep back foreign



matter. The whole apparatus is screwed on to a strong table, and the manner of using it is as follows:—

The piston is screwed down to its lowest level, and after the apparatus has been filled with the requisite quantity of mercury, 10 glass balls of known volume are introduced, and the disc with the tube screwed in. Then the piston is screwed up until it stops at the rib below the larger cylinder. The level of the mercury in the graduated glass tube is then noted, or it is brought to a round number of cubic centimetres by removing some by means of a pipette. Then the wooden rod is pushed down the glass tube on to the mercury, and the wing-nut is tightened, thus fixing the rod. The piston is then screwed down until, on shaking the table, the glass balls are heard to knock against each other. This shows that the air which may have remained in the vessel is quite rarefied. Then the piston is screwed up again until a little below the original position, the wooden bar is taken out, and the piston allowed to go right up to the rib, and the level of the mercury, which may be called  $N$ , read off. If it is desired to be perfectly sure that no air remains in the mercury, the operation is repeated until no differences of level occur. The piston is again screwed down until the level of the mercury is below the disc. The apparatus is opened, the glass balls are carefully removed, and the piston screwed down to its lowest position. The powder is then put in, and the whole process repeated in order to expel all air. The level then obtained, which on at least two readings must be equal, is noted and called  $N_1$ . The volume of the powder is then given by the formula  $V + N - N_1$ , and its density by the formula,  $D = \frac{P}{V + N - N_1}$ , in which

$P$  is the weight of the powder;

$V$ , the volume of the glass balls in cubic centimetres;

$N$ , the number of cubic centimetres displaced by the glass balls; and,

$N_1$ , the number of cubic centimetres displaced by the powder.

The densimeter illustrated here is suitable for making determinations with 1200 grammes of powder.

#### 6. *BLANCHI'S DENSIMETER.*

In Bianchi's densimeter a vacuum is produced, which allows the absolute density of powder to be determined. There are two forms of this apparatus—one with a glass vessel for holding

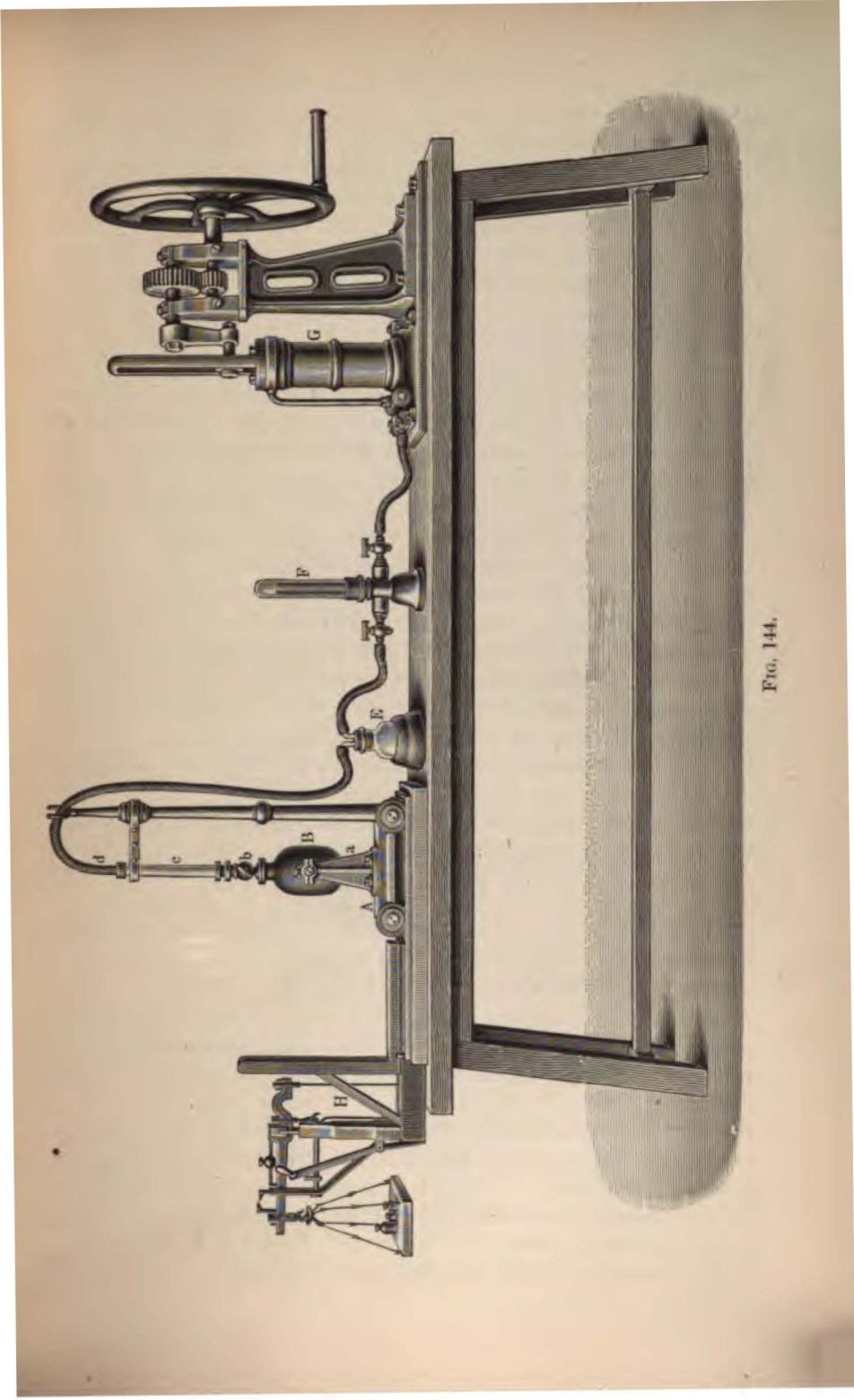

FIG. 144.

the mercury and the powder, which is used for fine-grained powders, and the other, a larger one, with a cast-iron vessel of much larger dimensions, which is used for large-grained powders. The apparatus for large-grained powders, illustrated in Fig. 144, is made by A. and R. Hahn, of Cassel. The densimeter proper consists of a small four-wheeled trolley (A) carrying the bearings (a), in which the oval measuring vessel (B) can be turned on cast-iron trunnions. The upper end of the measuring vessel has a socket with a tap (b), into which a gauge-tube (c) is screwed. The upper end has a screwed thread on to which an india-rubber hose is fixed. By means of a small glass tube put through a perforated cork, this tube is connected with a small glass vessel (E), and another india-rubber tube goes from a second hole in this cork into a vacuum-gauge (F), the other end of which is connected with an air-pump (G). After having screwed off the gauge-tube, the measuring vessel can be brought on the trolley to a small decimal balance, which, when the weights are put on, lifts the trolley so that it can be weighed.

The manipulation is as follows:—First of all the density of the mercury used is determined, which is done by means of a specific gravity bottle. This is weighed exactly, filled with water, weighed again, emptied and dried, then filled with mercury and again weighed. The density of the mercury ( $D\tau$ ) is then

$$D\tau^1 = \frac{\text{Weight of mercury} \times \text{Density of water at the temperature of the room.}}{\text{Weight of water.}}$$

The density of mercury at  $0^\circ$  C. is then  $D_0 = D\tau (1 + \frac{\tau}{5550})$ , and the density of the mercury at the temperature of the room is

$$D\tau^1 = D_0 \frac{5550}{5550 + \tau^1}.$$

In order to determine the density of the powder, a certain quantity is first weighed out. The measuring vessel is filled with mercury, and the apparatus fitted together. The tap of the measuring vessel is opened, and also the two taps of the vacuum-gauge, and the air is pumped out until the vacuum-gauge gives a steady reading. In this way any excess of mercury in the measuring vessel is carried to the overflow vessel, whilst the mercury in the barometric tube stands at the height corresponding to the vacuum obtained. After this the tap of the pressure-gauge is closed, and then the tap of the measuring vessel, the barometric tube is then screwed off, and the measuring vessel weighed on the decimal balance. The measuring vessel is then turned over on its trunnions so that the tap points downwards, the mercury

discharged, the tap screwed off, and the vessel brought back into position in order to introduce the weighed quantity of powder. After this is done the apparatus is again screwed together, the connection with the air-pump is made, and a vacuum produced. As soon as the mercury reaches its normal level, air is allowed to go back into the apparatus, and the whole operation is repeated. Then the tap of the measuring vessel is closed, the barometric tube taken off, and the apparatus again weighed.

The density of the powder will then be given by the formula

$$S = \frac{P \cdot d}{T - T_1 + P}$$

in which P is the weight of the powder examined ;

d, the specific gravity of the mercury at the temperature of the room ;

T, the weight of the measuring vessel filled with mercury ;

T<sub>1</sub>, the weight of the measuring vessel filled with mercury and powder.

As a rule, three determinations are made, and the average taken.

The apparatus for fine-grained powder is illustrated in Fig. 145. It has a glass vessel instead of a cast-iron one, and this has a tap (r) at the bottom and one (D) at the top, which are fixed by means of suitable fittings (B and C). The lower tap is continued in a small tube (a), and the barometric tube is closed by a tap (F). The whole apparatus rests on a cast-iron stand. The measuring vessel is filled by producing a vacuum after having closed the tap r and opened the taps D and F, then closing the tap D and opening r. For weighing the vessel the two screws (B and C) must be taken off, but the vessel must not be touched by hand.

The following is a comparison of various kinds of powder with regard to gravimetric and real density :

DENOMINATION OF THE POWDER.		DENSITY.	
		GRAVIMETRIC.	REAL.
Large-grained powder	Dutch ordinary ... ..	0·912	1·87
	Austrian ... ..	0·975	1·72
	Le Bouchet, angular powder ...	0·856	1·56
	Ettlingen ... ..	0·856	1·56
	Hounslow, angular powder ...	0·863	1·63
Cannon powder from	Denmark ... ..	0·871	1·72
	Bern, No. 6 ... ..	0·884	1·67
	Neisse, ordinary ... ..	0·909	1·77
	Berlin, new manufacture ...	0·909	1·63
	Neisse, new manufacture ...	0·909	1·67
	Russia, ordinary powder ...	0·914	1·56
	Denmark, round powder ...	0·953	1·72

## PROPERTIES OF BLACK POWDER

D: NOMINATION OF THE POWDER.	DENSITY.		
	GRAVIMETRIC.	REAL.	
Rifle powder from	{ Denmark, angular powder ...	0.863	1.77
	{ Hounslow ... ..	0.894	1.72
	{ Berlin, new manufacture ...	0.909	1.63
	{ Bern, No. 4 ... ..	0.919	1.67
Sporting powder from	{ Munich ... ..	0.939	1.82
	{ Le Bouchet ... ..	0.898	1.87
	{ Berlin, old manufacture ...	0.939	1.77

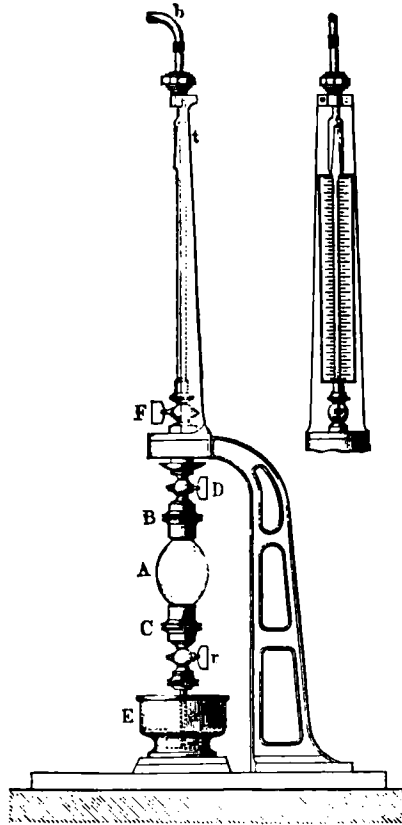

FIG. 145.

It will be seen from the above table that powders having the same real density do not always have the same gravimetric density. Therefore, to properly judge a powder, it is necessary to determine both densities.

The density gives a general idea as to the kind of materials



	PER CENT.
English, for Nordenfeldt guns ... ..	0·004
French, S. P., No. 3 ... ..	0·005
„ from Sèvres-Livry, 30 to 40 millimetres ... ..	0·007
Belgian, 15 millimetres ... ..	0·007
American, Du Pont cannon powder ... ..	0·016
„ hexagonal powder ... ..	0·002
„ powder of private manufacture ... ..	0·074

Cronquist further showed the percentage of calcium oxide in the following powders:—

	PER CENT.
Swedish, 5 millimetres ... ..	0·0070
„ 6 to 10 „ ... ..	0·0062
„ 15 „ ... ..	0·0081
„ 23 „ ... ..	0·0053
„ 35 „ ... ..	0·0084
English, 8 „ P. 3 ... ..	0·0097
„ 23 „ P. 1 ... ..	0·0063
Belgian, 15 „ ... ..	0·0055
American powder of private manufacture ... ..	0·0101
English, for Nordenfeldt guns ... ..	0·0006
American, Du Pont cannon powder ... ..	0·0005
„ hexagonal powder ... ..	traces
English powder P. ... ..	0·0011
„ prismatic, with 7 holes ... ..	0·0007
French powder, from Sèvres-Livry, 30 to 40 millimetres ... ..	0·0012
Düneberg, prismatic powder, 50 millimetres ... ..	0·0004

Cronquist says that sodium chloride is attacked by calcium salts ( $\text{CaSO}_4$ , etc.), especially in the presence of saltpetre, whereby calcium chloride is formed which is extremely hygroscopic. The calcium chloride on the surface becomes liquid by the moisture in the air, and dissolves some saltpetre, and the solution is distributed through the whole grain by the capillary action of the component particles. In this way the molecular cohesion of part of the saltpetre is destroyed, and it is no longer evenly distributed in the grain.

The charcoal also considerably influences the hygroscopic properties; as a rule, the more charcoal a powder contains, the more hygroscopic it is. Further, we have seen on page 66 that the lower the temperature at which it was manufactured, the more water can charcoal take up. Red charcoal will consequently absorb more water than black charcoal.

Damp powder can be restored by exposing it either to the sun, or in a dry, well-ventilated room. As a rule, powder will not have suffered by moisture, as long as an efflorescence of white crystals of



saltpetre does not appear. Moist powder gives a lower muzzle velocity and a shorter range. Green charges absorb more moisture than granulated powder, and fine-grained powder more than large-grained. On the other hand, it is more difficult to restore the properties of large-grained powder. Powder of a smaller gravimetric density absorbs more moisture than a powder with a greater one, and a glazed powder less than an unglazed one. It would seem that powder, after being dried, gives a greater velocity than before, evidently because it becomes porous. Experiments made at Spandau with powder which had absorbed 2.75 per cent. of moisture, and was then dried, showed with the ballistic pendulum 333 metres velocity before and 337 metres after the second drying. Similar results have been obtained in other places.

Powder that has become moist can be recognized by its unequal colour, by being more difficult to ignite, and giving greater residue, and also by the grains crushing more easily in the fingers. If it contain a large amount of moisture, the powder forms black hard lumps, in which state it is, as a rule, unserviceable.

In order to determine the tendency any particular kind of powder has for absorbing moisture, it is put, together with a standard powder, in a damp cellar, or over a layer of water in a tub, which can be closed air-tight, and is left for a shorter or longer period, according to the existing temperature. According to regulations made in Sweden in the year 1831, powder treated in such a way should not absorb, at most, more than 50 per cent. more moisture than the standard powder. In England it is specified that the powder shall be put into a double box, the outer one of which is made of wood and the inner one of copper, the space between the two being filled with an insulating material. This double box is closed by a double lid with a hole for inserting a thermometer. The powders to be examined are placed upon a small wire gauze tray about half-way up the inner box, and round the box at about the height of the tray a flat gutter is arranged containing a saturated solution of saltpetre, with which the bottom of the box is also covered. Two hundred grains of the powder to be examined are placed on a small tray with a wire gauze bottom, which is put into the box. On closing the lid the temperature is noted, and the sample left in the box for twenty-four hours for fine-grained powder, and forty-eight hours for large-grained. After this time the temperature in the interior of the

box is again noted, the powder taken out and weighed, when the increase of weight, of course, shows the quantity of moisture absorbed.

The following experiments made in Sweden with standard powder show how little reliance can be placed on such tests. Five samples of 100 grammes each were put into a tub at the same time, and they had increased in moisture :

DATE.	TEMPERATURE IN DEGREES C.	ABSORPTION OF MOISTURE IN PER CENTS.	
		Average.	Greatest difference.
27 May . . . . .	10·9	2·40	0·56
14 June . . . . .	16·6	6·70	3·19
18 July . . . . .	21·4	5·11	1·11
1 August . . . . .	18·1	6·99	1·53
26 " . . . . .	21·9	3·72	1·04
7 October. . . . .	13·6	6·43	1·18
17 " . . . . .	10·2	6·93	1·04
31 " . . . . .	7·5	6·63	0·76

This can easily be explained if it is considered that steam has a greater density at a high temperature than at a low one. If the temperature of the tub falls, part of the steam in the saturated air is condensed and moistens the samples. If the temperature rises again, the moisture thrown down is evaporated either in part or wholly, so that it really depends upon chance whether a powder appears more or less hygroscopic. For this reason it would be more advantageous to compare a damp powder with a less damp one by drying them simultaneously on a water-bath. The difference in weight would give the quantity of moisture evaporated, from which the hygroscopic properties of the powder could be deduced.

#### (f) DETERMINATION OF MOISTURE.

In England, the sample of powder is roughly crushed in a mortar, and 100 grains accurately weighed on a watch-glass. A second watch-glass, together with the one containing the powder, are dried in a water-oven at 160° F. for an hour, and are then allowed to cool in a desiccator for about twenty minutes.

In Germany five samples are taken from each supply and mixed together. Fifty grammes of this are then taken and dried in a porcelain dish by Fresenius' drying-stove in an air-bath for an

hour, at a temperature of between 185° and 194° F. The dish is then cooled under the dessicator and again weighed. The moisture should not be more than 1 per cent.

In France 100 grammes of powder are weighed and dried in a drying-stove on a copper plate at 158° F. until constant weight is obtained. All other countries proceed with this examination in a similar manner.

## 2. CHEMICAL EXAMINATION.

### (a) QUALITATIVE EXAMINATION.

If the ingredients contained in the powder to be examined are not known from the outset, it is advisable to first make a qualitative examination, the object of which is to determine what kind of nitrate is contained in the powder. A small quantity of powder is put on to a filter, hot water poured over it, the filtrate concentrated a little, and examined as described on page 38.

In order to determine whether the powder contains sulphur, a small quantity is placed in a beaker, and carbon disulphide poured over it. It is then allowed to stand for some time, and the solution carefully poured off into a porcelain dish. On evaporating, sulphur, if present, will crystallize out.

In order to separate the charcoal it is best to first extract a small quantity of the powder for some hours by means of carbon disulphide, then filter and wash with hot water, and finally dry the filter. By examining the residue under the microscope, it will be seen whether the carbonaceous ingredients consist of charcoal, wood pulp, bark, or other matter.

If other ingredients are supposed to be existing in the powder, they can be found qualitatively in the residue by the well-known methods.

### (b) QUANTITATIVE ANALYSIS.

The object of the quantitative analysis is to find the composition of the powder as it was intended to be in the manufacture. Therefore, the percentage of moisture is usually determined only in a cursory way, and the composition of the powder calculated on the dry weight.

## 1. DRYING THE POWDER.

In England, drying is done at 160° F.; in Germany, the regulation is that about 2 grammes of finely-crushed powder should be dried in an air-bath at 90° C. until constant weight is obtained; in Switzerland, it is dried on a water-bath at between 70° and 80° C.; and in France, the powder is put into a glass tube, and a current of dry air at 60° C. is passed through it. The latter method is preferable, because at a temperature above 60° C. sulphur begins to partially volatilize.

## 2. DETERMINATION OF SALTPETRE.

A method frequently employed is to put a weighed quantity of powder (as a rule, 5 grammes) on to a moist filter and to dissolve out the saltpetre by repeated washings with hot water. The solution of saltpetre first running off is collected in a weighed platinum dish and the subsequent wash-water in a beaker. The solution of saltpetre is then carefully evaporated, from time to time some of the wash-water added, and finally the remaining saltpetre is heated to 280° C.

Werther collects the solution of saltpetre and the wash-water in a large platinum dish, evaporates them to dryness, and transfers the residue with a platinum spatula into a small weighed platinum dish. This he closes with a cover, puts into a larger dish, and then heats to 280° C. It has to be noted that on lixiviating saltpetre it is hardly possible to avoid fine particles of charcoal passing through the filter; and this is the case to a greater degree with hot water, which expands the pores of the filter, than when cold water is used. If the saltpetre has been dissolved by hot water it will for this reason always show a brownish colour after evaporating. It would not be then advisable to melt the saltpetre, because small quantities of saltpetre would decompose, in which case the fused matter when dissolved in water would always show an alkaline reaction.

Marchand tried to determine the saltpetre contained in powder from the percentage of potassium by putting the powder into a platinum crucible, pouring an excess of sulphuric acid over it, and keeping it at a temperature below 200° C., when after a few hours all the nitrate was decomposed. It was then evaporated completely to dryness, calcined, and the acid potassium sulphate

transformed into the neutral salt. One hundred parts of potassium sulphate correspond to 116 parts of saltpetre. When this method was carefully tested, it was found to be unsuitable, because, although all the nitrate seemed to have been decomposed, yet the mass almost invariably exploded.

If one does not like to rely on the direct determination of the saltpetre, it will be much better to find its percentage of nitrogen by one of the many volumetric methods, of which Lunge's nitrometer method is specially suitable.

In order to determine quickly the percentage of saltpetre, Captain Becker, of the Austrian Artillery, proposed a method based on the specific gravity of saltpetre.

Four hundred grammes of powder are dissolved in 500 grammes of hot well or rain-water, the specific gravity of which has been previously determined, and then cooled down to  $17\frac{1}{2}^{\circ}$  C., the loss in weight having been made up by adding fresh water. The filtrate is then examined by means of a powder hydrometer, which is so graduated that each degree corresponds to  $\frac{1}{2}$  per cent. of saltpetre in the powder dissolved in the above quantity of water, so that it is only necessary to multiply the reading of the hydrometer by 20 to find the percentage of saltpetre contained in the powder. According to experiments made with this method by Marchand, it is not trustworthy, because the temperature influences it, and also because the variations in the specific gravity are so small (even with a difference of 2 per cent. in the percentage of saltpetre) that they cannot be determined with exactitude.

A method given by Uchatius is based on the same principle. Twenty grammes of powder are placed in a bottle with about 50 grammes of lead shot; 200 grammes of well-water are added to it by means of a graduated pipette, the bottle corked, and then shaken for eight minutes. After this the solution is filtrated and 172 grammes of the filtrate are put into a beaker, and raised to a standard temperature corresponding to the water employed. Into this is dipped a glass float, which is so constructed that when the powder contains 75 per cent. of saltpetre, the float just rises to the surface at the normal temperature, but sinks to the bottom if the liquid be diluted with four or five drops of water only. A sufficient quantity of a test liquid, of smaller or larger specific gravity, according to whether the saltpetre contains more or less than 75 per cent., is added from a graduated pipette until the float shows equilibrium.

For each quantity of water used the normal temperature has

to be found at which the float and a solution of 15 grammes of saltpetre in 200 grammes of that water have an equal specific gravity; that is to say, a temperature at which the float just rises in the solution, but sinks when three or four drops of the water are added. The test liquid of higher specific gravity is made by dissolving 20 grammes of saltpetre in 200 grammes of water; 7·017 grammes of it, filling one unit volume in the graduated pipette, must contain 0·160 gramme of pure saltpetre and 6·857 grammes of a solution as it would form on treating 20 grammes of powder of 75 per cent. with 200 grammes of water. Each unit volume added shows, therefore, that the powder examined contains 1 per cent. of saltpetre less than 75 per cent.

The test liquid of lower specific gravity is made by dissolving 10·184 grammes of saltpetre in 200 grammes of water. If 7·017 grammes of it, which are also taken as one unit volume, are added, they show 1 per cent. over 75 per cent. saltpetre in the powder examined.

According to a Swedish regulation of the year 1831, 625 grammes of distilled water were to be poured over 15 grammes of powder, and in a similar manner equal quantities of water were poured over quantities of pure saltpetre corresponding to 70, 75, and 80 per cent. of the powder, and the weight which is necessary to sink a hollow glass ball into these solutions on to a mark made on the thin stem determined.

Since the Government of Sweden is partly supplied with powder by private manufacturers, the saltpetre is at the same time tested for sodium chloride in the following manner:—50 grammes of powder are extracted with water and nitrate of silver added. The silver chloride precipitate is dried and weighed, and the weight, after deducting that of the filter, is multiplied by 410, which gives the amount of sodium chloride contained in 50 kilogrammes of powder. This should not be more than 15 grammes.

### 3. DETERMINATION OF SULPHUR.

The amount of sulphur contained in a powder may be ascertained in different ways; it may either be determined directly as sulphur, or first transformed into sulphuric acid. If it be desired to weigh the sulphur as such, the following process according to Berzelius is used:—The mixture of sulphur and charcoal after the saltpetre has been extracted is dried on the filter and weighed; it

is then transferred to one of the bulbs of a double-bulbed tube. A current of dry hydrogen is passed over the mixture whilst the latter is heated until all sulphur has been distilled over into the second bulb. The tube and its contents are then allowed to cool down, the current of hydrogen being continued during the cooling. The tube between the two bulbs is cut by means of a file, and the bulbs weighed separately. Their contents are then removed, and the bulbs again weighed, when the relative proportion of the two substances can be calculated from the two weighings.

In this process some sulphur is always carried away by the current of hydrogen—a defect in the method which Wöhler proposed to remedy by using a long tube in place of the second bulb. The tube was filled with a weighed quantity of copper borings, which, on being strongly heated, would combine with all the sulphur distilling over. The increase in weight of the copper gave the quantity of sulphur present.

In this method, as in all others, the mixture of sulphur and charcoal is weighed after the saltpetre has been dissolved out. It should be noted that it is extremely difficult to determine exactly the weight of the material put into the bulb, as, on account of the hygroscopic properties of charcoal, appreciable quantities of water are always condensed whilst filling. In order to avoid this error, Marchand proposed that the mixture should be dried in a vacuum over sulphuric acid until on repeated weighing no difference in weight was found, that as much as possible of the dried mixture should then be poured into a weighed bulb-tube, and the quantity remaining on the filter again dried in a vacuum and weighed. By this method the influence of the atmosphere is excluded as far as possible, but another circumstance is overlooked which may cause considerable errors. On dissolving out the saltpetre, the charcoal, on account of its lower specific gravity, has the peculiar property of creeping up on the filter and settling above the sulphur, so that the latter fills the point of the filter. If, therefore, before being placed in the bulb-tube the mixture be not intimately mixed (during which a loss of charcoal dust has to be guarded against), a substance of a different composition to the remainder will be analyzed. A further error with this method is that the sulphur cannot be completely separated from the charcoal, as Proust has shown, although his hypothesis that a special hypsulphite is formed cannot be proved. Marchand's opinion that the sulphur is combined with the potassium in the ashes of the charcoal is open to question, and it is much more probable that



the sulphur forms combinations with metal particles which are found in powders, especially in those that have been incorporated in drums with bronze balls—a process in which, as has been previously shown, a considerable wear of the bronze balls takes place.

In France sulphur was formerly always extracted by means of carbon di-sulphide. For this purpose the finely-crushed powder was put on to a filter moistened with alcohol in a glass funnel with a ground edge. The point of the funnel was closed by means of a cork. Carbon di-sulphide was poured over the filter and a ground-glass lid laid over the funnel. After two hours' digestion the cork was taken away, the liquid drawn off, and the digesting process repeated until a few drops of the liquid when evaporated on a sheet of platinum left no residue. The solution was collected in a weighed flask and evaporated in a water-bath at between 70° and 80° C. The residue was then carefully heated until it just began to melt. The carbon di-sulphide vapours were driven out by a current of dry air and the flask again weighed. This method is no longer used, since, in spite of repeated extraction, the powder always contains small quantities of the allotropic modification of sulphur which is insoluble in carbon di-sulphide.

In Switzerland, the filter containing the sulphur and charcoal after the extraction of saltpetre is moistened with warm water and the sulphur extracted by repeated infusions with ammonium sulphide, and finally washed out with a dilute solution of ammonium sulphide and hot water. The filter is dried and weighed, when the weight after deducting that of the filter gives the weight of the charcoal, and the loss, the weight of the sulphur.

One of the oldest processes, in which the sulphur is converted into sulphuric acid, is due to Hermbstädt. It consists in mixing the finely-ground powder with an equal weight of pure saltpetre, melting double the quantity of saltpetre used in a platinum crucible, and adding the mixture of saltpetre and powder in small quantities. After all has thus been deflagrated, the residue is dissolved in water, neutralized with nitric acid, and the sulphuric acid formed precipitated by means of barium nitrate. From the resulting barium sulphate the quantity of sulphur contained in the powder can be calculated. It is difficult to avoid loss with this method, since the powder falling on to the melting saltpetre will always cause spurting, and consequently a loss of material.

The method now chiefly used is that of Gay-Lussac, in which 3 grammes of finely-ground powder are mixed with an equal

quantity of pure potassium or sodium carbonate that has been previously slightly calcined in order to drive off all moisture, 5 grammes of saltpetre and 20 grammes of sodium chloride, both of which must be free from sulphates and previously dried, then being added.

According to the German regulations, sodium carbonate is used, and for each part of powder one part of saltpetre and six parts of sodium chloride are added. After the whole has been intimately mixed in a mortar, the mixture is heated for a prolonged period in a platinum crucible until it becomes white. After cooling, the molten mass is dissolved in water, acidified with a few drops of hydrochloric acid, and the sulphuric acid produced precipitated by means of barium chloride. The barium sulphate precipitated is collected on a weighed filter, carefully washed, dried, and weighed, and it gives the data required for calculating the percentage of sulphur.

It is also possible to add a barium chloride solution of known strength to the acidified liquid until no more precipitate is formed, and to calculate the sulphur from the quantity of barium chloride used, 152.63 parts of crystallized barium chloride corresponding to 20 parts of sulphur.

This method is one of the best if the substances are intimately mixed and the crucible is not too rapidly heated. Nearly the whole of the true percentage of sulphur will then be found.

If it is intended to combine the sulphuric acid produced by the oxidation of sulphur with barium during the heating, then, according to Löwig, one part of powder should be mixed with twelve times its quantity of a mixture consisting of one part of barium nitrate and three parts of barium carbonate. The mixture is put into a combustion tube and a layer of the mixture without powder, 8 or 9 centimetres thick, added. The tube is heated in a combustion furnace whereby the mass bakes together without melting, so that it can be easily taken out after cooling. The contents of the tube are boiled with dilute hydrochloric acid, and the barium sulphate formed is collected on a filter.

Another process has been proposed by Millon:—3 grammes of dried powder are put into a flask, 33 grammes of pure concentrated nitric acid poured over it, and 6 grammes of pure potassium chlorate added. The flask is heated, and after the development of gases has ceased, another small quantity of potassium chlorate is added, this being repeated until the liquid has become perfectly clear and yellow. Care has to be taken to add fresh nitric acid

to make up for the liquid lost by evaporation. The contents of the flask are then poured into a warm beaker, and the flask rinsed with hot water until no opaqueness appears on the addition of barium chloride. Barium chloride is then added to the liquid, and the analysis completed in the usual manner.

The disadvantage of this method is that sulphur can only be oxidized very slowly, as it soon begins to melt in the flask, and is then thrown to the top of the liquid in small globules, so that the potassium chlorate finds only very few points of attack. A further disadvantage is that besides barium sulphate, barium nitrate and potassium chlorate also remain on the filter, and are difficult to remove by washing. It is, therefore, best to proceed in the following way:—The residue is dried, and the filter burned and calcined, whereby all the potassium chlorate is transformed into potassium chloride. The residue is then digested with hydrochloric acid, well washed on a small filter, and again calcined with the filter.

Ure takes nitric acid instead of hydrochloric acid; but this is not to be recommended, as, on account of the stormy development of gases and swelling of the mass, very large flasks have to be used, and also because the oxidation proceeds much more slowly.

The process of Bottée and Riffault is based on the same principle as that of Millon. After having lixiviated the saltpetre with hot water, the mixture of sulphur and charcoal remaining on the weighed filter is carefully dried at a low heat, weighed whilst still warm, and then introduced into a flask by means of an ivory spatula, and a potassium hydrate solution of 5° B. poured over it. After boiling for some time it is filtered whilst boiling hot. It is then washed with double the volume of the potassium solution used, and finally the residue remaining on the filter is washed with hot water. Chlorine gas is conducted into the diluted solution of saltpetre and potassium hydrate in order to convert the sulphur into sulphuric acid, the latter being precipitated by means of barium chloride.

This method has not been largely used, since the potassium sulphide formed decomposes quickly in contact with air, and a small quantity of sulphur is lost in the shape of hydrogen sulphide; and also because charcoal is partly soluble in potassium hydrate solution, so that the sulphur will always come out high. It has the further disadvantage that by weighing the mixture in a hot state exactitude cannot be obtained.

Finally, the process of S. Cloëz and Er. Guignet should be

mentioned, in which potassium permanganate is used for oxidizing the sulphur. One gramme of dry powder is boiled in a flask with a concentrated solution of potassium permanganate, and pure potassium permanganate added from time to time until the liquid has assumed a permanent violet colour. The sulphur is oxidized to sulphuric acid and the charcoal to carbonic acid. Potassium permanganate being suspended in the liquid, concentrated hydrochloric acid is added, and the whole boiled until all permanganate is dissolved and the chlorine developed driven off. The liquid is then diluted and barium chloride added. This method gives satisfactory results.

#### 4. DETERMINATION OF CHARCOAL.

The oldest and rather primitive method for determining the percentage of charcoal in powder is due to Baumé (1780). The powder is put on to a dried and weighed filter, the saltpetre extracted, and the residue dried on the filter and weighed. The sulphur is then eliminated by burning, and the remaining charcoal weighed. From the weight  $\frac{1}{4}$  is deducted, since it is said that the charcoal retains that proportion of sulphur.

Another method, known already in 1821, was to boil the residue of sulphur and charcoal with a potassium hydrate solution. After this it was washed until no precipitate was produced by lead acetate in the washing-water, after which the charcoal was dried and weighed. This method cannot be recommended, since, as mentioned already on page 67, part of the red charcoal dissolves with a brown coloration in the potassium solution, and also because the solvent is only eliminated with difficulty from the charcoal, which always retains small quantities of sulphur. For the same reason another method, in which the sulphur is extracted by boiling the powder with sodium, potassium, or ammonium sulphide, cannot be recommended.

If the sulphur is washed out with carbon di-sulphide, absolutely exact results cannot be obtained, because some sulphur will always remain in the charcoal. The error becomes still larger when, according to the original proposal of Marchand, it is afterwards washed with absolute alcohol; for, according to Werther's observations, hot alcohol extracts some constituents from charcoal, especially that of 28 per cent. yield, and this, of course, causes the weight of the charcoal to come out too low.

Bolley's attempt to replace the carbon di-sulphide by sodium

sulphite, which in the presence of sulphur is transformed into a thiosulphate, did not give much better results. According to Bolley, the residue containing sulphur and charcoal, after being dried and weighed, is boiled for from one to two hours with 20 to 24 parts of sodium sulphite, the water lost by evaporation being constantly replaced by fresh quantities. After filtering, the charcoal is washed, dried, and weighed. The charcoal, however, always retains considerable quantities of the salt, which cannot be eliminated by washing.

Oil of turpentine, used by Ure, has proved to be quite unsuitable, since it is retained by the charcoal in large quantities.

Bromeis's process is said to give better results. He fixes a small funnel air-tight into the neck of a flask by means of a cork, puts the mixture of sulphur and charcoal on to the filter, and pours over it petroleum-ether heated to from 120° to 140° C., and then covers the funnel with a glass plate. At this temperature the sulphur melts, and at once dissolves in the petroleum-ether. By removing the cork after five minutes, the liquid hitherto retained on the filter runs into the flask; it is then washed several times with petroleum-ether, the filter pressed out between blotting-paper and dried in a water-bath at 100° C., which causes it to lose all smell of petroleum-ether in about half-an-hour. The charcoal remaining on the filter, which is then perfectly free from sulphur, is weighed.

In order to obtain exact results, the charcoal obtained by any of the above-mentioned processes should always be examined for sulphur by one of the methods just described.

Instead of weighing the charcoal directly as such, it can also be transformed into carbonic acid, from the amount of which the quantity of charcoal can be calculated. The process used in this case is the same as that for determining carbon in organic compounds containing sulphur.

If copper oxide is used for the initial development of oxygen, the insertion of a tube containing lead peroxide between the calcium chloride tube and the potassium apparatus, in order to retain the sulphurous acid, must not be omitted.

Weltzien recommends filling 10 centimetres in front of the oxide with copper turnings. If powder that has been dried at 100° C. be examined, the determination by the carbonic-acid method always comes out too low, as potassium carbonate is formed during combustion, and remains in the combustion tube. It is, therefore, better to free the charcoal as much as possible from sulphur before drying, and to burn it with lead chromate,

a current of oxygen being passed through the tube towards the end of the combustion. By this method the oxygen and hydrogen contained can also be determined.

The percentage of ash is determined by simply calcining one gramme of the dry charcoal from the powder in a platinum crucible until constant weight is obtained.

According to the German regulation, the filter containing the sulphur and charcoal is put into a funnel, which in turn is placed in a metal funnel heated with warm water to between 30° and 40° C. Pure carbon di-sulphide, to which about one-quarter of its volume of alcohol has been added, is poured on to the filter, which is then well washed with pure alcohol, and finally dried at 90° C. and weighed. The weight obtained, less the weight of the filter, gives the percentage of charcoal, and the sulphur is found by difference.

##### 5. DETERMINING ALL COMPONENTS SIMULTANEOUSLY.

In order to determine all the components of powder, Linck has proposed the following process:—A glass tube with a long point (a, Fig. 146) is connected with a weighed flask (c) by means of the cork (b). The dried powder is put into the tube, and over it is poured carefully-rectified carbon di-sulphide, which runs through the point of the tube (a) into c. As soon as by repeated washing the flask is filled with about 8 cubic centimetres of liquid, it is heated in a water-bath to between 70° and 80° C., when the carbon di-sulphide distils over into the dry tube (d). The distillate is used for repeating the extraction. After extracting about six times with 8 cubic centimetres of carbon di-sulphide, all the sulphur which can be extracted from the powder will have been removed. The sulphur remaining in the flask (c) is carefully heated until it just fuses, and after cooling it is weighed.

In order to ascertain whether the powder still contains sulphur which cannot be extracted, the tube (a) is connected with an aspirator, and dry air at 100° C. is sucked through until constant weight is obtained. The difference between the weight obtained and the weight of the tube containing the dry powder is equal to the weight of sulphur extracted, including the small quantity of water which powder dried at 100° C. may retain. This small quantity can be found by deducting from the difference above mentioned the quantity of sulphur found by direct determination.

In order to find the small quantity of sulphur still contained in

the residue after extracting, about 0·6 gramme is taken out. The powder taken out is oxidized by aqua-regia, evaporated with hydrochloric acid, and the sulphuric acid formed is determined by barium chloride. The sulphur is calculated, from the barium sulphate formed, for the whole of the mass, and this is added to the quantity of sulphur found by direct determination. In this manner Linck found an additional 0·11 per cent. of sulphur.



FIG. 146.

The powder retained in the tube is then used for determining the percentage of saltpetre. For this purpose the tube (a, Fig. 147) and the vessel (d) are fixed air-tight under the bell-jar (b) of an air-pump by means of the india-rubber connection (e). The flask (c) is put under the bell-jar. Cold water is poured over the mass contained in the tube (a), and by very slowly pumping out the air from the bell-jar, the water is sucked out, so that it comes drop by drop into the flask (c). In order to avoid crystallization of



the saltpetre on the point of the tube (e), this operation is repeated with water of gradually increased temperature; for this the vessel (d) has, of course, to be filled with warm water. In this way two grammes of powder can be completely freed from saltpetre by means of 18 to 24 cubic centimetres of water, and by this means all the errors which may occur by using large quantities of water through the extraction of appreciable quantities of organic matter from the charcoal are avoided.



FIG. 147.

The solution of saltpetre is evaporated in a platinum crucible, the residue dried at  $120^{\circ}$  C. and then weighed. The asbestos plug is then pushed up by means of a piece of wire so as to loosen it, and the charcoal retained by it dried at  $100^{\circ}$  C. in a current of dry air. If the weight of the charcoal is a little more than the difference between the weight of saltpetre and charcoal, less that of the saltpetre found, then this difference is accounted for by the fact that pure charcoal retains water more easily than when mixed with saltpetre. This small difference (between 1 and  $1\frac{1}{2}$  milligrammes) has therefore to be considered as water adhering to the

charcoal, and has to be deducted from the water obtainable in the combustion of the charcoal.

For the combustion of charcoal, it is mixed in the tube with a little lead chromate, the drawn-out point is cut off, and the asbestos plug pushed up and mixed with the contents until a current of air can pass over the mass freely; then the whole is put into the combustion tube filled with oxidized copper borings, and the whole burnt in the usual manner in a current of oxygen.

### 3. MECHANICAL PROPERTIES OF BLACK POWDER.

#### (a) INFLAMMABILITY.

Black powder can be ignited by a blow, by increase of temperature, or by contact with burning or incandescent bodies.

Aubert, Lingke, and Lampadius have ascertained that black powder can be ignited by a blow with iron on iron, iron on brass, brass on brass, and less easily by a blow of iron on copper, or copper on copper. According to English experiments black powder is also ignited by a blow with brass on copper, iron on marble, quartz on quartz, lead on lead, and lead on wood—that is to say, if a leaden bullet is shot against a wooden pendulum covered with powder.

Under ordinary circumstances, a blow of copper on wood rarely produces an explosion, and one of wood on wood never. The reports of the Inspectors of Explosives, which now cover a period of many years, show nevertheless that every year there are accidents in mines resulting from explosions produced by blows of copper on stone, and even wood on stone. Very many accidents happen in mines through the workmen forcing cartridges of compressed black powder into bore-holes which in some parts are smaller than the diameter of the cartridge, or which are not quite round, when they use the rammer and sometimes even a hammer to drive it in. In such cases explosions may happen, even when wooden rammers are used. It cannot be assumed that the explosion in such a case is due to iron nails or similar foreign matter contained in the cartridge, because the presence of such articles is almost everywhere most carefully avoided, and they would have been already noticed when the powder was compressed. It is much more probable that small particles of powder detached by the breaking of the cartridge adhere to the sides of the bore-hole, and that the hard blow of the hammer on

to the tamper is transmitted to the rock, producing vibrations so violent that the powder explodes. This is the more probable since Dr. Dupré has shown that a blow struck in a slanting direction (glancing blow) produces the strongest vibrations and develops the most force, since the whole of the force of the blow is concentrated in one point, and for a single moment only, by the instrument producing it. Dr. Dupré has also shown that there is hardly any explosive which, when laid in a thin layer on a wooden floor, will not explode, when it receives a glancing blow with a wooden broom-stick.

Experiments made at Bouchet in 1852 have shown that the presence of finely-powdered quartz, glass, etc., when powder is being worked in incorporating-mills, soon produces explosion.

The temperature of ignition of black powder varies with the nature of the powder. Horsley found it to be 600° F. The apparatus he used for making the determination was a small saucer heated on an oil-bath, the temperature of the oil in which was taken by a thermometer dipped into it.

Leygue and Champion proposed another method in 1871 for determining the temperature of ignition. This was based on the well-known distribution of temperature in a metal rod which is heated at one end. They used a copper rod, 0.025 metre diameter and 0.600 metre long. Cavities situated at equal distances along the rod were filled with oil, or Darcé's alloy, in order to determine the temperature of the interior of the rod. Thermometers were placed at every 100 millimetres from the cold end of the rod in these cavities. The temperature indicated by the thermometers was noted, and the substances to be examined were put on to the rod and gradually pushed nearer and nearer to the source of the heat until they reached a point where they either decomposed or ignited. In order to avoid the influence of radiant heat, a screen was put between the apparatus and the source of heat. By this method the point of ignition of sporting powder was found to be 550° F. (288° C.), and that of cannon powder 563° F. (295° C.).

According to Leygue and Champion, the grains cake together on account of the sulphur they contain, and at the same time the sulphur begins to volatilize as soon as the temperature of the powder is increased beyond 212° F. The volatilization of sulphur increases rapidly with the temperature, and if this is not increased up to the boiling-point, the sulphur can be completely driven out of the powder without inflammation taking place. If the sulphur is finally eliminated, the temperature can be further increased, so

that even the saltpetre melts, and is finally decomposed by the charcoal floating on the top of it. If, on the other hand, the temperature is rapidly increased before the sulphur is completely volatilized, then the sulphur vapour is ignited and brings about the explosion of the powder.

Violette determined the temperature of ignition of various kinds of powder by throwing them on to molten tin which was heated to different temperatures. His experiments gave the following results:—

			GRANULATED	
			ANGULAR POWDER.	MEAL POWDER.
Blasting powder	...	...	270° C.	265° C.
Rifle powder	...	...	276° „	266° „
Fine sporting powder	...	...	280° „	268° „
Extra fine sporting powder	...	...	320° „	270° „

It seems to be clear from these figures that the temperature of ignition of meal powder of all kinds is about the same, and that very little depends on the composition of the powder. On the other hand, the shape and size of the grains and the more or less intimate mixture of the powder have, no doubt, considerable influence on the temperature of ignition.

Burning bodies only ignite gunpowder when they are very hot. This is well shown in attempting to ignite blasting powder by a match. As long as there is an ordinary flame the powder will not ignite, but as soon as there is a narrow-pointed one coming out, it ignites instantly. A gas flame will only ignite powder after it has acted upon it for a few seconds. Gun-cotton burned over black powder leaves it perfectly unaltered, because the combustion of the latter takes place so rapidly that the powder is not heated sufficiently to ignite. German tinder ignites powder only after having become incandescent, but if there is the least ash on the point no inflammation takes place. Sparks from steel and stone ignite the powder easily, if produced by a hard blow. Experiments made by the author with flint and steel have shown that the inflammation depends on the hardness of the blow, and whether only a small particle of the stone has been hit or not. It is possible to produce sparks of longer or shorter duration and larger or smaller intensity, and that under special conditions quite a shower of sparks may fall upon the powder without igniting it, whereas a single spark of great intensity at once starts combustion.

Colonel Hess has investigated the suitability of various kinds

of stone for constructional work in gunpowder factories, more especially for incorporating-mills. He found that quartz easily produces sparks, feldspar and apatite fairly easily, tough fluor spar very easily indeed, whilst calcareous spar never gives sparks. He concluded, therefore, that tough lime-stones, fine-grained marble, tough dolomites and homogeneous stones of equal hardness can, as a rule, be used without objection for parts of a machine subject to a friction on metal, provided the stones be free from sand. It is nevertheless advisable to examine such stones before using them by striking an edge of the same with the edge of a well-hardened steel hammer, because in these kinds of stones there are also varying degrees of hardness.

An electric spark ignites powder only when the discharge is delayed by the interposition of a bad conductor, which can be shown in small experiments by introducing a wet piece of twine into the circuits. For military and mining purposes special electric detonators are used for the explosion of powder charges. They are either high-tension detonators in which the electricity generated by a frictional machine jumps a gap in a wire, and through the resistance of air at the gap produces a spark which ignites some easily-inflammable substances placed round the gap; or they may be low-tension detonators, in which a continuous current of electricity produced in some convenient way renders a fine platinum wire incandescent, which inflames the igniting composition placed round it. Detailed information on such detonators, and the machines used for firing them, are fully described in the author's handbook on 'Blasting.'

#### (b) RAPIDITY OF COMBUSTION.

If small quantities of black powder are ignited in the open air, combustion only takes place, whilst if larger quantities are ignited they explode. The latter is sure to occur if the powder is ignited under high air-pressure, or, what is the same thing, in a closed space. If ignited in the open air, powder behaves differently according to the size of the grains. Piobert studied this subject carefully, and found that meal powder burns most slowly, and that, on the other hand, the larger the grains the slower the combustion. This is explained by the fact that the combustion of the powder progresses from the surface towards the interior, and that, therefore, when meal powder is in a heap, the flame finds its way through the heap with difficulty; and also that, with large-

grained powder, the outer layer at first burns away and presents less surface in relation to the volume at the beginning than do comparatively small grains. When considering the rapidity of combustion, the composition of the powder, the quality of the charcoal, and the density of the grains have also to be taken into account. The less the charcoal is burned the more rapidly it will take fire; on the other hand, red charcoal is less inflammable than black charcoal, on account of its higher percentage of hydrogen. In a closed space the inflammation takes place much more rapidly, but on account of the space being filled with gases of combustion, the rate of inflammation differs. With combustion in a closed space the decomposition takes place without a report, since air is wanting. In a vacuum, powder, as we shall see later on, does not ignite at all.

In order to test the rapidity of combustion of powders, special apparatus have been employed which will be described later.

#### (c) COMBUSTION.

If good black powder be ignited on white paper, it burns away rapidly, the smoke ascending vertically, and leaves no residue on the paper. If black spots be found, they indicate, either that the powder contains too much charcoal, or that it has been badly mixed; the same can be said of the sulphur, if yellow spots be left behind. If unburned grains be found, they indicate an imperfect or impure saltpetre. The powder should not burn any holes into the paper, as only moist or otherwise bad powder does so.

Professor Charles E. Munroe has suggested a pyrographic method for examining the quality of black powder. He uses paper sensitized with cyanide of iron, the blue colour of which is destroyed by the sulphites and thiosulphates formed by the combustion of the powder, with the formation of yellow and white spots. A piece of such paper about 8 inches square is moistened and laid on a glass or copper plate. A hollow blunt lead cone holding about 3 cubic centimetres is filled with powder by closing its point with the finger, and then it is reversed on the paper. A small conical heap is thus formed, which is then ignited by an incandescent wire. If the paper be allowed to stand for half a minute, and afterwards washed in running water, only small and uniformly distributed spots will be seen with well-mixed powder; whereas a badly-mixed powder gives large spots of unequal form and

division. Powder-cake from incorporating-mills will, according to the perfection of the mixture, show residual particles thrown about nearer or further from the centre of ignition.

In a closed space the combustion of powders of equal composition, but varying in size of grains, gives the same quantity of gases and the same temperature; whilst with combustion in the open air and under ordinary pressure sporting powder burns away much more violently than blasting powder, although both may have the same composition. That this is not the case with combustion in a closed space has been proved by experiments with the author's power-gauge, of which more will be said later on.

Papacino d'Antoni found in 1765 that the more rarefied the air in which it burns the more difficult is the ignition of black powder; that it will melt in the highest vacuum obtainable; and that it will only ignite when the saltpetre is heated up to its temperature of decomposition.

In 1817 Munke found that gunpowder does not explode in a vacuum-tube by rapid heating. Very soon afterwards Heerden observed that powder could not be exploded in a vacuum by a platinum wire made incandescent by an electric battery, and all that occurs when it is so treated is, that part of the sulphur melts and sublimes. As soon as he re-admitted part of the air, however, an explosion at once took place.

Slightly different results were obtained by Bianchi, who filled a small basket made of platinum wire with powder and put it under the bell-jar of an air-pump, and after having exhausted the air, heated the basket to incandescence by an electric current. The powder burned away slowly, but without deflagration. Bianchi states that the temperature was at least 2000° C.

These experiments were repeated by Heeren at a congress of natural philosophers in Hanover, and he came to the conclusion that when platinum wire was placed below the powder and kept incandescent for a prolonged time, Bianchi's results were confirmed, but that if the platinum wire merely dipped into the powder and was only incandescent for a short time, the grains near it melted without burning. If the incandescence was kept up for a longer time, those grains immediately touching the wire burned away slowly, whilst the remainder of the powder was not affected.

Heeren tried to explain this phenomenon by suggesting that the gas escaping from the exploding body, which, by its high temperature, would otherwise communicate the flame to the neighbouring particles, expands so rapidly on account of the lack



of resistance of the surrounding air, that it cools down below the temperature of ignition of the neighbouring particles.

Similar observations were made by Sir Frederick Abel. He found that if small quantities of powder were touched with an incandescent platinum wire under the bell-jar of an air-pump at from 150 to 510 millimetres pressure, the grains in the immediate neighbourhood of the wire melted, sulphur vapours were developed, and the grains were finally ignited, throwing about the unignited remainder of the powder. At 760 millimetres pressure complete inflammation took place after a few seconds. The same results were obtained with nitrogen, carbonic acid, and other gases which do not support combustion.

#### (d) PRODUCTS OF COMBUSTION.

On burning gunpowder under ordinary or high pressure, the transformation always takes place in such a way that, on the one hand, gaseous products, and on the other a solid residue, are formed. This was observed at a very early date, and at the beginning of the eighteenth century experiments had already been made to determine the quantity of gases produced. Hawksbee (1702) found that 1 cubic centimetre of black powder gives 232, Robin (1743) 244, Saluces (1761) 264, and Brianchon 400 cubic centimetres of gases, all reduced to 0° C. and 760 millimetres. On account of the primitive state in which chemistry was at that time, they could not then determine whether the products of combustion consisted of one or several gases. This led to much speculation; for instance, Newton, in 1705, thought that the sulphuric acid formed by the combustion of the sulphur drove out the spirit of nitre from the saltpetre and burned it. The same view, though with a slight modification, was still held in 1771 by Majow, who thought that phlogiston combined with the nitric acid. Ingenhouse (1782) is somewhat clearer in saying that the action of the powder is produced by the combination of the charcoal with the oxygen.

It was left for Gay-Lussac to give an approximately correct idea of the composition of the gases. He dropped powder, grain by grain, into a red-hot glass tube fitted with an arrangement for collecting the gases evolved. In this way he obtained from 1 litre of sporting powder weighing 900 grammes—

	LITRES.
Carbonic acid ... ..	238
Carbonic oxide ... ..	22·50
Nitrogen ... ..	189
	449·50

According to Gay-Lussac and Chevreul, 100 parts of the gaseous products of combustion contained—

	GAY-LUSSAC.	CHEVREUL.
Carbonic acid ... ..	45·4	53
Nitrogen ... ..	37·5	42
Carbonic oxide ... ..	—	5
Nitric oxide ... ..	8·1	—
Carburetted hydrogen ... ..	0·6	—
A peculiar gas consisting of carbon, hydrogen, and oxygen ... ..	8·3	—
	99·9	100·00

In the solid residue, the nature of which was until then quite unknown, Gay-Lussac and Chevreul found potassium sulphate and carbonate, and also potassium sulphide and higher “sulphurets.”

The experiments made by Bunsen and Schischkoff on sporting powder were epoch-marking. They have since been repeated by Linck with Würtemberg rifle powder. For more easy comparison, the two results are placed side by side in the following table :—

COMPOSITION OF THE POWDERS EXAMINED.

	BUNSEN AND SCHISCHKOFF. SPORTING POWDER.	LINCK. RIFLE POWDER.
Saltpetre ... ..	78·99	74·70
Sulphur ... ..	9·84	12·45
Charcoal {	Carbon ... ..	7·69
	Hydrogen ... ..	0·41
	Oxygen ... ..	3·07
	Ashes ... ..	trace
Water ... ..	—	0·60
	100·00	99·99

Bunsen and Schischkoff used for the combustion of the sporting powder a bulb-tube bent at a right angle on one end. Into this part of the tube reached another glass tube, 2·5 millimetres wide and 1 metre long, and provided at its upper end with a brass fitting, through the centre of which there was a small circular opening. The other straight part of the bulb was con-

nected with a tube 2.5 millimetres wide and between 1.5 and 2 metres long, through which a thin aspirating tube passed nearly up to the bulb. Small collecting tubes were connected with the aspirating tube which had their ends drawn out to a fine point and were connected to an aspirator. On making the experiment the bulb tube was heated, and an india-rubber tube put over the glass tube of 1 metre length. The india-rubber tube contained about 20 grammes of sporting powder, and as it was lifted grains of powder fell through the circular opening of the brass fitting into the hot bulb, where they burned away. The solid residue remained, almost completely, in the bulb and its tubular prolongation, whilst the gases settled in the tube of 1.5 to 2 metres in length, and were finally carried, by means of aspirators, into the collecting tubes closed by means of pinch-cocks, which then were fused under the blow-pipe.

The residue deposited in the bulb had the following composition:—

	PER CENT.
Potassium sulphate ... ..	56.62
Potassium carbonate ... ..	27.02
Potassium thio-sulphate ... ..	7.57
Saltpetre ... ..	5.19
Potassium hydrate ... ..	1.26
Potassium sulphide ... ..	1.06
Carbon ... ..	0.97
Potassium sulphocyanide ... ..	0.86
Sulphur ... ..	trace
	100.55

The methods by which the various substances were determined may be briefly mentioned.

To determine the unconsumed charcoal, 7 grammes of the substance were dissolved in hot water, and the charcoal collected on a weighed filter. The filtrate was brought into contact with copper oxide, and after two days the oxide, which then contained copper sulphide, was dissolved in fuming nitric acid and the sulphuric acid formed precipitated by barium chloride. The potassium thiosulphate was determined by titration with iodine solution. The potassium sulphate was determined by precipitation with barium chloride, and the potassium carbonate, by adding manganese chloride to the solution, and treating the residue after drying with diluted sulphuric acid in an apparatus for the determination of carbonic acid. The oxide of manganese which remained in the solution was precipitated by sodium carbonate,

and the percentage of potassium hydrate calculated on the supposition that when the potassium sulphide was determined all the potassium had been transformed into potassium hydrate. The potassium sulphocyanide was determined colorimetrically by a solution of iron chloride and a titrated solution of potassium sulphocyanide. The nitric acid of the saltpetre was transformed into ammonia by means of zinc and sulphuric acid, and the percentage of saltpetre calculated from this.

The vapour had the following composition :—

	PER CENT.
Potassium sulphate ... ..	65.29
Potassium carbonate ... ..	23.48
Potassium thiosulphate ... ..	4.90
Potassium nitrate ... ..	2.48
Carbon ... ..	1.86
Potassium hydrate ... ..	1.33
Potassium sulphocyanide ... ..	0.55
Ammonium sesqui-carbonate ... ..	0.11
	100.00

Side by side with these experiments, Bunsen and Schischkoff made another set, in order to determine the quality of products of combustion, solid and gaseous, given off by a certain quantity of powder on combustion. They obtained 0.6806 gramme of solid residue and 0.3138 gramme, or 193.1 cubic centimetres of gases for 1 gramme of powder.

Linck obtained in the same way 0.6415 gramme of residue and 0.3581 gramme, or 218.35 cubic centimetres of gases at 0° C. and 760 millimetres pressure. The solid residue had the following composition :—

	BUNSEN AND SCHISCHKOFF	LINCK.
Potassium sulphate ... ..	62.10	45.08
Potassium carbonate ... ..	18.58	23.96
Potassium disulphide ... ..	—	14.94
Potassium monosulphide ... ..	3.13	—
Potassium thiosulphate ... ..	4.80	5.83
Ammonium sesqui-carbonate ... ..	4.20	3.18
Charcoal ... ..	1.07	2.85
Potassium nitrate ... ..	5.47	1.87
Potassium sulphocyanide ... ..	0.45	1.81
Sulphur ... ..	0.20	0.48
	100.00	100.00

About the same time as Vignotti, Craig pointed out that the products of combustion are totally different, according to whether the explosion be produced under a high or a low pressure. By examining the residue, he found that if powder be burned under a low pressure, potassium sulphate remains, whereas with a high pressure the potassium sulphate is reduced to potassium sulphide, and thus the latter is chiefly formed. This theory has been still further confirmed by experiments made by Fedorow.

Fedorow obtained his powder residue by firing a pistol which he put into a glass tube 4 feet long, and also by firing a copper 9-lbs. gun, using with the latter three Russian pounds of powder for each shot. The composition of the powder and the charcoal was as follows:—

	PER CENT.		PER CENT.
Saltpetre ...	74.175	Carbon ...	72.5
Charcoal ...	14.835	Hydrogen ...	2.9
Sulphur ...	9.890	Oxygen ...	22.3
Water ...	1.100	Ashes ...	2.3
	<hr/>		<hr/>
	100.000		100.00

The residue was dissolved in water, filtered, and the filtrate shaken for several days with cadmium carbonate. The percentage of sulphur in the potassium sulphide was calculated from the cadmium sulphide formed. This gives much more exact results than the copper-oxide method used by Bunsen and Schischkoff. The potassium thiosulphate was determined by precipitating it with silver nitrate. The potassium sulphocyanide was found colorimetrically (according to Bunsen's method), and the potassium carbonate by adding manganese chloride and weighing the  $Mn_3O_4$  precipitated. The percentage of saltpetre was found from the difference.

The following analysis is the average of several results agreeing well with each other:—

COMPOSITION OF THE RESIDUE CALCULATED UPON 100 PARTS OF DRY POWDER.

	BLANK CHARGE OF				CANNON FIRED WITH	
	100 grammes		10 grammes		3 LBS. CHARGE.	
$K_2SO_4$ ...	48.25	47.61	40.83	43.28	15.00	15.15
$K_2CO_3$ ...	23.44	24.13	30.96	31.40	37.00	36.20
$K_2S_2O_8$ ...	16.33	17.03	19.22	17.74	8.28	7.44
$K_2S$ ...	0.97	0.54	2.49	1.67	38.18	39.55
$KNO_3$ ...	5.81	5.06	2.79	1.73	—	—
$KCN$ ...	0.34	0.34	0.36	0.36	0.33	0.33
N ...	0.38	—	—	—	0.09	0.09
C ...	4.66	4.49	3.03	3.21	—	1.02
Sand, CuO	—	—	—	—	0.82	0.22
$(NH_4)_2CO_3$	Trace	Trace	Trace	Trace	—	—

However interesting these experiments are from a scientific point of view, their results cannot be applied to military practice, because, in the latter, combustion always takes place under high pressure. Károlyi made experiments in this direction with rifle and cannon powder. The quantitative composition he obtained was—

FOR CANNON POWDER.				FOR RIFLE POWDER.			
Saltpetre	...	...	73.78	Saltpetre	...	...	77.15
Sulphur	...	...	12.80	Sulphur	...	...	8.63
Charcoal	{	Carbon	10.88	Charcoal	{	Carbon	11.78
		Hydrogen	0.38			Hydrogen	0.42
		Oxygen	1.82			Oxygen	1.79
		Ashes	0.31			Ashes	0.28
<hr/>				<hr/>			
100.00				100.00			

Károlyi used for his experiments a 60-lbs. shell from which the air was exhausted; into this a cast-iron cylinder holding the powder to be examined was screwed. Means were provided at one end of the cylinder for electric ignition. The strength of the cylinder and its cubical capacity were so proportioned that the gases from the explosion in the shell had a pressure of half an atmosphere, so that they could be transferred into the measuring vessels for further examination. The determination of the gases and of the solid residue was done according to Bunsen's methods.

36.8366 grammes of powder were used; they gave 25.49 grammes of solid residue and 11.34 grammes of gases, corresponding to 7621.9 cubic centimetres at 0° C. and 760 millimetres pressure. Therefore, for each gramme of powder 0.692 gramme of solid residue and 0.307 gramme, or 206.91 cubic centimetres of gases were obtained. The 25.49 grammes of solid residue had the following composition:—

	GRAMMES.	PER CENT. BY WEIGHT.
Potassium sulphate	13.61	53.39
Potassium carbonate	7.14	28.01
Sulphur	1.73	6.79
Potassium thiosulphate	1.04	4.08
Ammonium sesqui-carbonate	0.99	3.88
Charcoal	0.94	3.69
Potassium sulphide	0.04	0.16
	<hr/>	<hr/>
	25.49	100.00

The composition of the 11·34 grammes of gases was as follows :—

	GRAMMES.	PER CENT. BY VOLUME.
Carbonic acid ... ..	6·40	42·74
Nitrogen ... ..	3·60	37·58
Carbonic oxide ... ..	0·97	10·19
Hydrogen ... ..	0·04	5·93
Marsh gas ... ..	0·15	2·70
Sulphuretted hydrogen ... ..	0·10	0·86
Loss ... ..	0·08	—
	<hr/> 11·34	<hr/> 100·00

34·153 grammes of rifle powder were used for combustion, giving 22·247 grammes of solid residue and 11·906 grammes of gases, or 7738 cubic centimetres at 0° C. and 760 millimetres pressure, therefore 1 gramme of powder gave 0·651 gramme of residue, and 0·348 gramme or 226 cubic centimetres of gases. The analysis of the residue gave the following results :—

	GRAMMES.	PER CENT. BY WEIGHT.
Potassium sulphate ... ..	12·354	55·53
Potassium carbonate ... ..	7·096	31·90
Ammonium sesqui-carbonate ... ..	0·908	4·08
Charcoal ... ..	0·887	3·99
Potassium thiosulphate ... ..	0·605	2·72
Sulphur ... ..	0·397	1·78
	<hr/> 22·247	<hr/> 100·00

The analysis of the gases showed the following figures :—

	GRAMMES.	PER CENT. BY VOLUME.
Carbonic acid ... ..	7·442	48·90
Nitrogen ... ..	3·432	35·33
Carbonic oxide ... ..	0·504	5·18
Hydrogen ... ..	0·047	6·90
Marsh gas ... ..	0·167	3·02
Sulphuretted hydrogen ... ..	0·079	0·67
Loss ... ..	0·235	—
	<hr/> 11·906	<hr/> 100·00

Károlyi concluded from these experiments that the products of combustion of the powder depend very little on the way in which combustion takes place, but the composition of the powder has an influence. Considerable opposition has been offered to this conclusion; amongst others by Vignotti, who, in his paper, 'De l'analyse des produits de la combustion de la poudre,' Paris 1861, contended that the temperature of combustion of the powder must



bear some relation to the products of combustion. As a proof, he gave the results of the examination of three kinds of powder of the same composition (75 per cent. of saltpetre, 12·5 per cent. of sulphur, and 12·5 per cent. of charcoal), of which No. 1 was made with charcoal of 22 per cent. yield, No. 2 with one of 32 per cent., and No. 3 with one of 39 per cent. Twenty grammes of each kind were burned in an apparatus differing only from that of Károlyi's in that the powder was burned in a small mortar in the presence of air. The result was—

PER GRAMME.	No. 1.	No. 2.	No. 3.
	Cubic centimetres.	Cubic centimetres.	Cubic centimetres.
Gas developed ... ..	243·96	231·62	237·14
Carbonic acid (gas) ... ..	119·33	136·765	145
	Grammes.	Grammes.	Grammes.
Solid residue ... ..	1·1475	0·6500	0·5604
<i>Insoluble parts—</i>			
Unconsumed carbon ... ..	0·834	0·543	0·4019
" sulphur ... ..	0·2135	0·107	0·1585
Sulphur in $K_2SO_4$ developed	1·116	1·836	2·17
Carbon in $K_2CO_3$ .. ..	0·1868	0·3765	0·443

Firing experiments with the ballistic pendulum showed that the muzzle-velocity of powder No. 1 was larger than that of No. 3; but that, on the other hand, when fired from a 24-lbs. gun, the charge being equal to one-third of the weight of the projectile, No. 3 gave the highest, No. 2 the smallest, and No. 1 a velocity between the other two.

Considering the quantities of gases obtained, Vignotti concludes that, with the small charges used in the ballistic pendulum experiments, the larger quantity of gas was the determining factor in the case of No. 1 powder; whilst in the 24-lbs. gun, where lower ballistic effects were observed, the temperature of the gas must have neutralized the effect of the larger quantity of gases developed, giving an advantage to powder No. 3. Therefore, with small charges of powder No. 3, the loss of pressure is not counterbalanced by the temperature of combustion on account of the small volume of gas; but with larger charges, where comparatively less heat is absorbed by the sides of the gun, greater velocity and pressure are produced. The quantity of carbonic acid present confirms this supposition. It has, therefore, also been said, Vignotti's experiments show that the more carbonic acid and the more potassium carbonate are present, the more carbonate will in general be formed, and the higher will be the temperature of combustion.

About the same time as Vignotti, Craig pointed out that the products of combustion are totally different, according to whether the explosion be produced under a high or a low pressure. By examining the residue, he found that if powder be burned under a low pressure, potassium sulphate remains, whereas with a high pressure the potassium sulphate is reduced to potassium sulphide, and thus the latter is chiefly formed. This theory has been still further confirmed by experiments made by Fedorow.

Fedorow obtained his powder residue by firing a pistol which he put into a glass tube 4 feet long, and also by firing a copper 9-lbs. gun, using with the latter three Russian pounds of powder for each shot. The composition of the powder and the charcoal was as follows:—

	PER CENT.		PER CENT.
Saltpetre ...	74.175	Carbon ...	72.5
Charcoal ...	14.835	Hydrogen ...	2.9
Sulphur ...	9.890	Oxygen ...	22.3
Water ...	1.100	Ashes ...	2.3
	100.000		100.00

The residue was dissolved in water, filtered, and the filtrate shaken for several days with cadmium carbonate. The percentage of sulphur in the potassium sulphide was calculated from the cadmium sulphide formed. This gives much more exact results than the copper-oxide method used by Bunsen and Schischkoff. The potassium thiosulphate was determined by precipitating it with silver nitrate. The potassium sulphocyanide was found colorimetrically (according to Bunsen's method), and the potassium carbonate by adding manganese chloride and weighing the  $Mn_3O_4$  precipitated. The percentage of saltpetre was found from the difference.

The following analysis is the average of several results agreeing well with each other:—

COMPOSITION OF THE RESIDUE CALCULATED UPON 100 PARTS OF DRY POWDER.

	BLANK CHARGE OF				CANNON FIRED WITH	
	0.75 grammes		1.5 grammes.		3 LBS. CHARGE.	
$K_2SO_4$ ...	48.25	47.61	40.83	43.28	15.00	15.15
$K_2CO_3$ ...	23.44	24.13	30.96	31.90	37.00	36.20
$K_2S_2O_8$ ...	16.53	17.03	19.32	17.74	8.28	7.44
$K_2S$ ...	0.97	0.54	2.49	1.67	38.18	39.55
$KNO_3$ ...	5.81	5.86	2.79	1.73	—	—
$KCN_3$ ...	0.54	0.54	0.56	0.56	0.33	0.33
S ...	0.38	4.49	3.05	0.22	0.09	0.09
C ...	4.08	—	3.05	2.90	—	1.02
Sand, CuO ...	—	—	—	—	0.82	0.22
$(NH_4)_2CO_3$ ...	Trace	Trace	Trace	Trace	—	—

It will be seen from this interesting table that on increasing the charge and the pressure of combustion, a more thorough decomposition of the powder takes place, the percentage of potassium sulphide and carbonate in the residue increases in the same proportion as it decreases in potassium sulphate and potassium thiosulphate.

Finally, experiments made by Dr. Poleck at Neisse in August and September 1865 require notice. In order to find the composition of mine-gases, he made an experimental mine for the purpose, and led through the mound a long wrought-iron pipe connected with an aspirator for collecting the gases. The collecting-tubes were fused by a blow-pipe immediately after each collection of gases; these were subsequently analyzed by Bunsen's method. The powder used for blasting the mines contained—

	PER CENT.
Saltpetre ... ..	72·00
Sulphur ... ..	11·88
Charcoal ... ..	16·12
	100·00

The results are given in the following table:—

Composition in 100 parts.	Immediately after the explosion.	½ hour after.	8 hours after.	6½ hours after.
Carbonic acid ...	4·49	3·45	2·28	2·22
"    oxide ...	2·98	3·39	3·26	2·72
Marsh-gas ... ..	—	0·20	0·15	—
Hydrogen ... ..	—	1·09	0·58	0·88
	—	—	—	0·58
Oxygen ... ..	4·88	12·73	17·15	16·48
Nitrogen ... ..	87·65 <sup>1</sup>	79·14	76·58	77·12
	incl. Hydrogen.			
Total ...	100·00	100·00	100·00	100·00

Therefore in 100 parts

Powder gases ...	76·72	39·27	18·18	21·38
Atmospheric air ...	23·28	60·73	81·82	78·62

<sup>1</sup> The endiometric part of this analysis was spoiled.

On looking over this table, it will be at once noticed that the quantity of carbonic acid found is small. The explanation for this is to be found in the fact that the tamping material absorbs carbonic acid more largely than the other gases present. In order to examine the influence of the tamping material on the absorption of the gases, on the sixth day, when the mine had been cleared,

the gases absorbed were recovered by boiling the tamping material in vacuo with water free from air. The tamping material in this way was found to contain in 100 parts—

	PARTS.
Carbonic acid ... ..	73.32
Hydrogen ... ..	1.11
Nitrogen protoxide ... ..	0.81
Nitrogen ... ..	24.76
	<hr/>
	100.00

This also explains why the gases issuing into the mine-gallery immediately after the explosion had a different composition to those developed later on from the tamping material. It cannot be seen why later the quantity of carbonic acid is larger than it is immediately after the explosion, and this so much the less because no carbonic oxide could be found in the tamping material, and it is out of question that the carbonic acid should have been reduced afterwards to carbonic oxide.

As regards the presence of marsh-gas, this may well have been formed, at the high temperature set up, from the charred organic components of the tamping material, although if sulphuretted hydrogen and carbon disulphide were present, as Poleck seems to assume, then any other mode of formation is impossible. Poleck, especially mentions that sulphates were not to be found in the tamping material; they might well, however, have been oxidized during the six days the air had access to it.

However carefully these experiments may have been made, it cannot be said that a perfect idea of the quantity of the products of combustion can be obtained from them. On account of the great absorption of carbonic acid by the tamping material, the quantitative proportions could not well be considered, so that the table gives only an idea of the qualitative composition of the products of combustion from blasting powder. The solid residue was also left unconsidered, although it must be admitted that in this case it was difficult to examine it.

Noble and Abel have made very extensive and minute experiments on the combustion of black powder, and have published their results in the 'Proceedings of the Royal Society' for 1874 and 1880. They used two cylindrical explosion vessels made of mild steel, holding one and half a litre respectively. The vessels had three openings, one of which was closed by means of a screw-plug, fitted with a contrivance for electrically igniting the mixture. Into the second a piece of pipe connected with an india-rubber tube for

carrying away the gases of combustion was screwed, while the third was provided with a crusher-gauge for measuring the pressure set up. The permanent gases were collected in a special gas-holder, and in from five to fifteen minutes after the explosion were transferred to tubes, which were at once sealed in the blow-pipe. As it adhered firmly to the cylinder, the solid residue had to be chipped off with a chisel, and was kept in a dry bottle until analyzed.

On account of objections raised, especially by Berthelot, against the results published in 1874, Noble and Abel experimented in 1880 upon a larger number of powders. The powders used and their analysis are shown in the following table:—

KIND OF POWDER.	Saltpetre.	Sulphur.	CHARCOAL.					Potassium sulphate.	Potassium chloride.	Water.
			Total.	Carbon.	Hydrogen.	Oxygen.	Ashes.			
Pebble powder, W. A. ...	74·67	10·07	14·22	12·12	0·42	1·45	0·23	0·09	—	0·95
R. L. G., W. A. ...	74·43	10·09	14·29	12·40	0·40	1·27	0·22	0·13	—	1·06
F. G., W. A. ...	73·55	10·02	14·59	11·36	0·49	2·57	0·17	0·36	—	1·48
Curtis and Harvey's, No. 6	74·40	10·37	13·78	10·66	0·52	2·29	0·31	0·29	Trace	1·17
Spanish cylindrical powder	75·30	12·42	11·34	8·65	0·38	1·68	0·63	0·27	0·02	0·65
Blasting powder ...	61·66	15·06	21·41	17·93	0·66	2·23	0·59	0·12	0·14	1·61

Large numbers of experiments were made with these powders under varying proportions (D) between the volume of the powder and capacity of the explosion vessel. The volume of the permanent gases, reduced to 0° C. and 760 millimetres pressure per gramme of dried powder of the various kinds examined, was as follows:—

	CUBIC CENTIMETRES.
Pebble powder, W. A. ...	278·3
R. L. G., W. A. ...	274·2
F. G., W. A. ...	263·1
Curtis and Harvey's, No. 6 ...	241·0
Spanish cylindrical powder	234·2
Blasting powder ...	360·3

In the table on p. 348 the maximum and minimum of the single components of the products of combustion, as found by Noble and Abel, are given.

The tables originally calculated by Noble and Abel were based upon the supposition that no potassium di-sulphide had been formed by the combustion of the powder. Experiments made by Débus in 1882 have convinced Noble and Abel that potassium

PRODUCTS OF COMBUSTION.	PEBBLE POWDER.		R. L. G., W. A.		F. G., W. A.		CURTIS AND HARVEY'S No. 6.	SPANISH CYLINDRICAL POWDER.	BLASTING POWDER.	
	Maximum.	Minimum.	Maximum.	Minimum.	Maximum.	Minimum.				
Gaseous Products	CO <sub>2</sub> ...	27·85	25·05	27·60	24·80	28·92	24·90	25·93	24·57	22·79
	CO ...	5·72	3·67	5·81	3·09	5·80	2·59	2·47	1·36	15·22
	N ...	11·76	11·03	12·26	10·51	11·71	10·65	11·32	11·08	8·58
	HS ...	1·83	0·71	1·77	0·62	1·53	0·82	0·83	0·97	3·89
	C <sub>2</sub> H <sub>4</sub> ...	0·14	—	0·17	0·01	0·10	—	0·46	—	0·70
	H ...	0·09	0·04	0·40	0·03	0·10	0·05	0·08	0·03	0·17
	O ...	—	—	0·22	—	0·10	—	—	0·07	—
Total of gaseous products	44·84	43·18	43·69	42·15	43·72	41·47	41·09	38·08	51·35	
Solid Products	KO.CO <sub>2</sub>	37·11	29·77	38·02	28·77	34·34	25·08	34·13	21·86	19·45
	KO.SO <sub>3</sub>	8·58	5·28	14·03	2·76	14·01	10·42	12·50	29·75	0·28
	KS ...	12·49	6·66	10·83	6·20	12·14	4·73	7·17	4·73	17·45
	KCyS ...	0·33	0·03	0·21	—	0·15	—	—	0·02	1·39
	KNO <sub>3</sub> ...	0·27	—	0·33	—	0·16	0·05	0·17	0·58	0·04
	KO	—	—	—	—	3·15	—	—	—	—
	NH <sub>4</sub> O.CO <sub>2</sub>	0·09	0·03	0·08	0·02	0·09	0·01	0·05	0·02	0·84
	S ...	6·17	2·34	7·18	2·72	5·79	2·33	3·72	4·31	6·64
C ...	—	—	0·41	—	—	—	—	—	0·95	
Total of solid products	56·82	55·13	57·86	56·31	58·53	56·28	58·91	61·92	48·65	

di-sulphide is actually formed, and therefore the table given above was re-calculated by them with due regard to Débus's work.

Débus considered the combustion of the powder to be effected in two processes, which take place one after the other. The first is an oxidation, when potassium sulphate and carbonate, carbonic acid, free nitrogen, and perhaps also carbonic oxide are formed; and the second a reduction, where untransformed carbon reduces the potassium sulphate formed by the oxidation, and at the same time free sulphur decomposes the potassium carbonate. He is of opinion that potassium di-sulphide is formed in the second process.

Those wishing to obtain more information in this matter will find it in the original publications of these authors.<sup>1</sup>

<sup>1</sup> Noble and Abel, 'Researches on Explosives,' II. Fired Gunpowder. Philosophical Transactions of the Royal Society, 1874 and 1880; also Débus, Liebig's 'Annalen,' 1882, vol. cexii., p. 257; vol. cexiii., p. 15; vol. cclxv., p. 657; compare also Nickel, 'Zeitschrift für physikalische Chemie,' 1892, p. 454.

C. W. S.  
U. S.







