

MAGICIAN'S ARSENAL

PROFESSIONAL TRICKS
OF THE TRADE

TEXT & ILLUSTRATIONS BY LEE SCOTT

"Where does he get those wonderful toys?" — Jack Nicholson as the Joker in the movie *Batman*

Magician's Arsenal is no ordinary magic book. True, it does contain professional sorcerers' secrets involving smoke, mirrors, escape hatches, and sleight of hand, and Lee Scott has been a professional magician for more than 30 years. But he also has at least as much experience as a practicing "powder monkey," and the tricks in here all have a special twist: they combine the illusion of magic with the firepower of improvised explosives, incendiaries, firearms, electronics, and other F/X secrets. Most magicians don't use flamethrowers, sleeve cannons, and death cards in their acts, but Scott does—and now so can you.

"All my life I have dreamed of finding a book like this. Little did I know that I would be the guy to write it," the author remarks. Impress all your friends and fans by conjuring up a few of his favorite easy-to-construct tricks. But remember, all of the devices and techniques presented in this book are extremely dangerous and should be undertaken by trained professionals only. This information is presented for information purposes only.

A PALADIN PRESS BOOK

ISBN 0-87364-741-6

ISBN 0-87364-741-6



9 780873 647410



MAGICIAN'S ARSENAL

PROFESSIONAL TRICKS
OF THE TRADE



PALADIN PRESS
BOULDER, COLORADO

"Where does he get those wonderful toys?"
—Jack Nicholson as the Joker in the movie *Batman*

"Burn, baby, burn!"
—The Penguin (Danny DeVito)
Batman Returns, 1992

"Who is a prisoner?
The man who does not let his imagination run free."
—Anthony Blake (Bill Bixby, who is a real magician)
"The Magician" television series

Magician's Arsenal: Professional Tricks of the Trade
by Lee Scott

Copyright © 1993 by Lee Scott

ISBN 0-87364-741-6
Printed in the United States of America

Published by Paladin Press, a division of
Paladin Enterprises, Inc., P.O. Box 1307,
Boulder, Colorado 80306, USA.
(303) 443-7250

Direct inquiries and/or orders to the above address.

All rights reserved. Except for use in a review, no
portion of this book may be reproduced in any form
without the express written permission of the publisher.

Neither the author nor the publisher assumes
any responsibility for the use or misuse of
information contained in this book.

TABLE OF CONTENTS

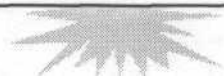

Fire Flower.....	1	Escape Tools.....	56
Hand Flasher.....	2	Escape Tricks.....	58
Impact Smoke Bomb.....	4	Thermite Escape Methods.....	62
Gravity Holdout.....	5	Rope Work.....	64
Hot Shot I.....	7	Magician's Escape-and-Evasion Kit.....	65
Hot Shot II.....	9	Lock Pick Guns (Improvised).....	70
Flash Fire.....	10	Sparks.....	72
Shotgun-Shell Devices.....	12	Shooting Wand, Cane, or Staff.....	74
Ballistic Cane or Umbrella.....	14	Self-Lighting Fuze Principle.....	76
Sleeve Cannon.....	16	Miscellaneous Weapons and Effects.....	78
Spit Fire.....	18	Gas Jet.....	80
Self-Lighting Match.....	19	Secret Hiding Places.....	81
Exploding Balloons.....	20	Burglar Deterrent I.....	83
Exploding Balloons II.....	22	Burglar Deterrent II.....	85
Human Blowtorch.....	23	Sleeve Darts.....	87
Bottle Rocket Gun.....	24	Unbelievable.....	89
Digital Time-Delay Weapon-Firing System.....	25	Flame-Lifting Methods.....	90
Psychokinetic Scrambler.....	27	Selected Flames and Fires.....	92
Fog Machine and F/X Effect with Fog Machine and Movie Projector.....	29	Utility Device.....	95
Remote-Controlled Weapon-Firing System.....	31	Firecracker Devices.....	97
Rattrap Cigarette Weapon-Firing System.....	32	Pick-a-Card.....	99
Up to One-Hour Time-Delay Weapon-Firing Method.....	33	Impact Smoke Bomb II.....	101
F/X Remote-Controlled Pull/Reel.....	34	<i>Appendix A</i>	
Telephone Remote Control Weapon-Fuzing System.....	35	How to Make Flash Paper and Flash Powder.....	103
Shocker.....	36	<i>Appendix B</i>	
Shocker Deluxe.....	38	Improvised Radio Detonation Devices.....	104
Squib Work.....	39	<i>Appendix C</i>	
Squib Vest.....	42	Initiating Actions.....	105
Whiz Bang I & II.....	46	<i>Appendix D</i>	
Death Cards.....	48	Supply Sources.....	106
Flamethrower.....	50	<i>Appendix E</i>	
Ignitor.....	51	Magic Dealers.....	107
Lit Candle from Coat.....	53	Bibliography.....	108
Flash Pots and Flash Pans.....	54		

WARNING

The procedures to be followed in this manual and the resulting end products are extremely dangerous. Whenever dealing with explosives or incendiaries, special precautions should be followed in accordance with industry standards for experimentation and production. Failure to strictly follow such standards may result in harm to life and limb.

Check all applicable laws before building anything in this manual. Certain Bureau of Alcohol, Tobacco, and Firearms regulations, as well as state and local ordinances, may apply to some of the improvised firearms and pyrotechnic

devices. Make sure you know and obey all the laws regarding firearms or explosives. Ignorance of the law is no excuse.

The author, publisher, and distributors disclaim any liability from any damages or injuries of any type that a reader or user of information contained within this manual may encounter from the use of said information. Use this manual and any end product or by-product at your own risk. This manual is for information purposes only!

All manufacturing rights reserved by author.

FIRE FLOWER

Every kid at one time or another has had a squirt flower, which can be bought in any joke shop very cheaply. The fire flower is nothing more than the standard squirt flower filled with a flammable filler. As of this writing, I know of no magician who has ever used this device in his or her act. I am sure this book will change that, so be the first one on the block to try it in your act.

There is not much to constructing this device. The only things you need are a squirt flower and a flammable filler. Either 151 rum or lighter fluid works well. However, I have found that these squirt flowers generally are poorly constructed and tend to leak at one or both ends of the

rubber tube where it connects to the flower or squeeze bulb, so I prefer to use 151 rum as my filler in the bulb. The squeeze bulb should be hidden in a pocket where you can easily reach it.

Fire the device at any open flame, but a candle or lighter is best. It may take you awhile to become proficient at aiming the flower at a candle, but it is time well spent. Practice makes perfect, so don't get discouraged. This trick is great fun to play with.

While you are at the joke shop picking up a squirt flower, also buy a squirt ring. This same effect can also be accomplished with this novelty item.

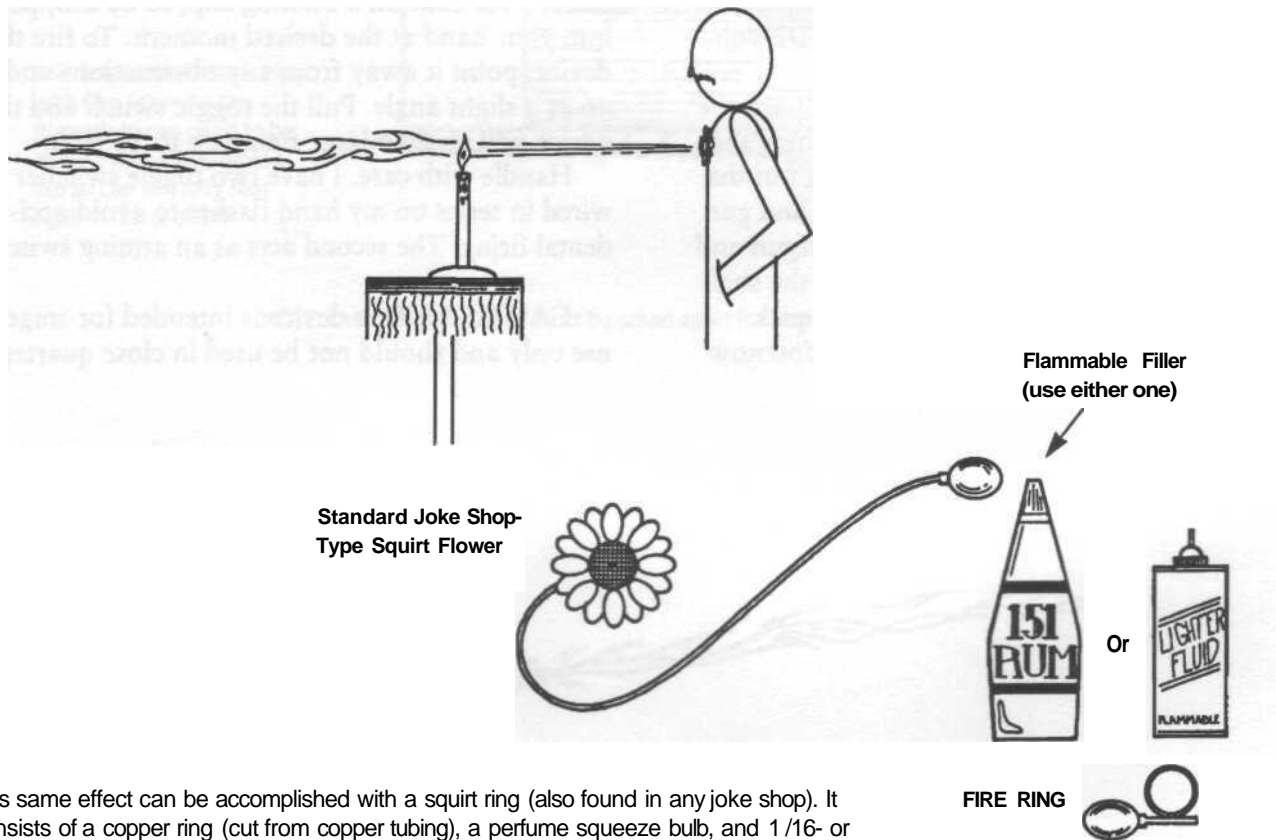

This same effect can be accomplished with a squirt ring (also found in any joke shop). It consists of a copper ring (cut from copper tubing), a perfume squeeze bulb, and 1/16- or 1/8-inch tubing soldered on to ring.

WARNING: THE EFFECTS AND DEVICES IN THIS BOOK ARE EXTREMELY DANGEROUS AND SHOULD BE UNDERTAKEN BY TRAINED PROFESSIONALS ONLY. THIS MATERIAL IS PRESENTED FOR INFORMATION PURPOSES ONLY.

HAND FLASHER

The hand flasher is standard in every magician's repertoire. It is a sure-fire attention getter. If you do stage magic and don't presently use one of these devices, I highly recommend that you consider it.

The homemade device in the accompanying illustration is much more powerful than any hand flasher I have ever bought. Treat it as you would a gun—after all, it does fire a modified shotgun shell—and check your local and state laws. In some areas it is illegal to construct this device without a license.

To make, you need a piece of schedule 40, nominal 3/4-inch-wide steel pipe, no more than 3 inches in length, threaded at one end. Drill a hole in the center of the pipe cap no more than 1/8 inch in diameter. You will also need a 1 1/2-volt AAA battery and toggle switch.

We now come to the most important part: the shotgun shell modification. Start by opening the top of a 12-gauge shotgun shell, pouring out the lead shot, and removing the plastic wad and gun powder. Now place the shell in your shotgun and fire, thus disarming the primer. Remove the shell and pry out the dead primer with an ice pick (push it from the inside with the pick). You now

have a hole in the shell where the primer was. Attach a flashbulb to wire leads and insert the leads through this hole from the inside. Pour the gunpowder back in and reinsert the plastic divider. Now insert 3/4-inch balls of flash paper in the shell and close it up. The shell is done. Put the shell into the pipe and put the leads through the hole in the pipe cap. Make sure the switch is off, then screw the pipe cap on and attach the leads to the toggle switch and battery to make a complete circuit. Attach the toggle switch and battery to the pipe body with electrical tape or plastic connectors. The hand flasher is complete.

The unit is compact enough to be totally concealed in your hand. You might hide the unit under your coat on a bulldog clip, to be dropped into your hand at the desired moment. To fire the device, point it away from any obstructions and up at a slight angle. Pull the toggle switch and the device will shoot a large flame up to 20 feet.

Handle with care. I have two toggle switches wired in series on my hand flasher to avoid accidental firing. The second acts as an arming switch.

CAUTION: This device is intended for stage use only and should not be used in close quarters.

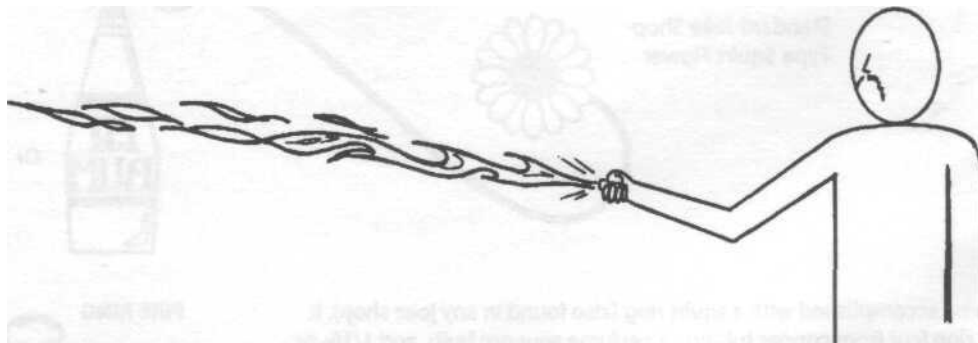

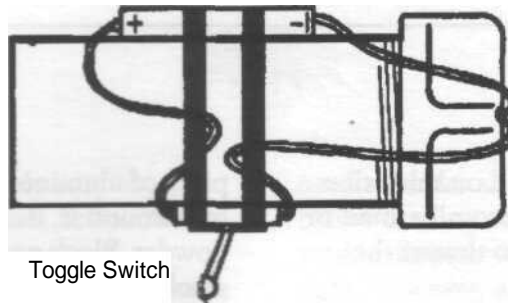

Toggle Switch

MODIFIED 12-GA. SHOTGUN SHELL

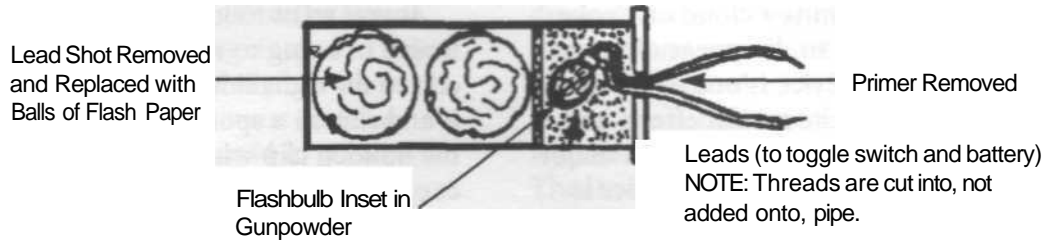

3/4" Schedule 40 Steel Pipe with Cap Screwed On (threads in cap need to be chased with a bottoming tap so cap will fully seat against rim of shell)

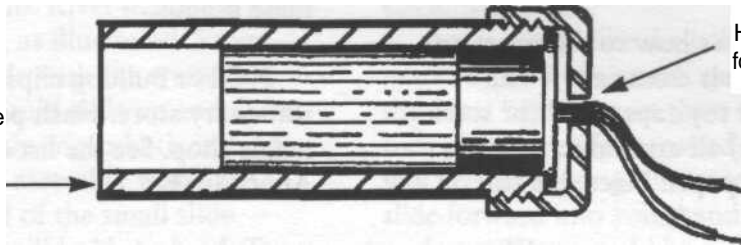

NOTE: Entire shotgun shell must be taken apart for lead shot and primer removal.

IMPACT SMOKE BOMB

You've seen these in movies and on television shows for years. Every cool dude from Batman to James West carries these around to thwart the bad guys.

Magicians use smoke bombs for stage shows. The magician throws a little silver ball on the ground, and it puffs and emits a cloud of smoke large enough to allow him to disappear off stage. The construction of this device is one of the most closely guarded secrets in the special effects and magic field. You are really being let in on a major secret here. The great thing about this device is that there is absolutely no fuze to light! You simply throw the ball on the ground, and it does the rest.

The illustration shows how to construct an impact smoke bomb. It is essentially a ball bearing that has paper toy caps glued (or stuck with double-stick tape) all around it, which is then wrapped in flash paper. Place this ball on a

piece of aluminum foil and, before wrapping the foil around it, dump in a few spoonfuls of black powder. Black powder creates a huge amount of smoke, so you will not have to obtain hard-to-find chemicals. After you've wrapped up the foil, the bomb is ready to go.

If you want to keep this device handy, attach a length of string to the ball. Now rivet a bulldog clip to the right side of your belt. Clip the ball to it and slip on a sports coat to hide it. By pressing the bulldog clip with your inner forearm and cupping your hand directly below the coat, you can squeeze the the ball right into your hand.

Enjoy! I know you'll have loads of fun with these bombs.

NOTE: Bulldog clips can be bought at any stationery store. Flash paper can be bought at any magic shop. See the list of magic dealers in Appendix E.

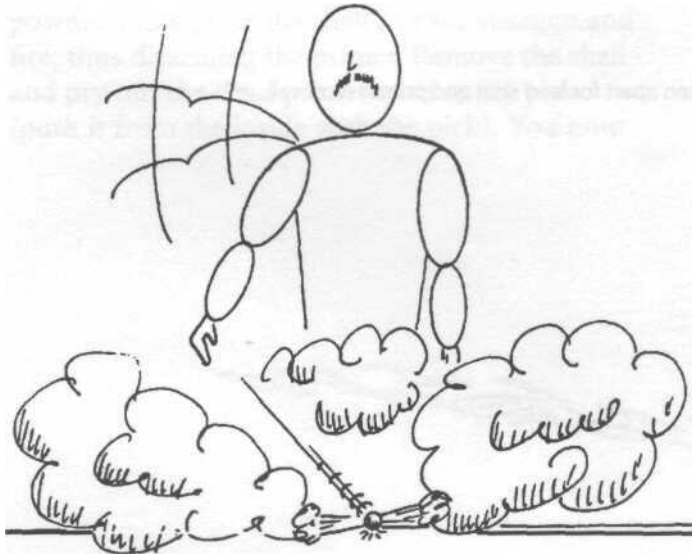

GRAVITY HOLDOUT

This heavy-duty holdout is fairly easy to construct, and most of the parts can be found in any hardware or furniture supply store.

You will need to buy a drawer slide, the kind found on almost all kitchen drawers, and cut the outer metal bar shorter. To find out how much, put the bar up to your forearm. Rest the bar on your forearm with one end up against your wrist. You will want the bar to be just slightly shorter than the distance between your wrist and the bend in your elbow. The bar should in no way prevent you from bending your arm freely.

Now drill two holes on each end of this bar and also put two holes in the middle of a new dog collar and a watchband. Rivet the collar and the watch band to the bar, as illustrated. From here, insert the smaller slide with the wheels on one side into the bar. It should slide up and down freely inside the bar. Slightly crimp both ends of the outer bar so the wheel assembly won't fall out. Affix a clip to the end of the small slide opposite the wheels. This will hold the load. To keep the inner slide in place until needed, you will

need to make another crimp in the outer bar just below the dog collar. This will allow you to wedge the rear wheel into it. Don't wedge it too tight, however, as you want it to slide forward when you need it. Gravity will do the rest.

To use, strap the device to your arm with the dog collar around your forearm and the watch band around your wrist. You will want to wear a coat with loose sleeves. The illustration on page 6 shows one way to use the device. The basic way is to let the load fall downward into your hand. The load may be secured either with the clip or with Velcro. The load can be fairly heavy since this device will hold up under the worst circumstances.

If you would like the holdout to trip automatically, you can attach springs on both sides of the outer bar. Connect them to the inner slide and then push the slide rearward into the crimp. This will keep the springs under tension and push the slide forward into your hand when released.

James West would be proud.

1. Entire assembly is made out of a drawer slide.
2. Gravity holdout watchband and collar riveted in place.
3. Load is secured with Velcro straps or any other similar attachment.

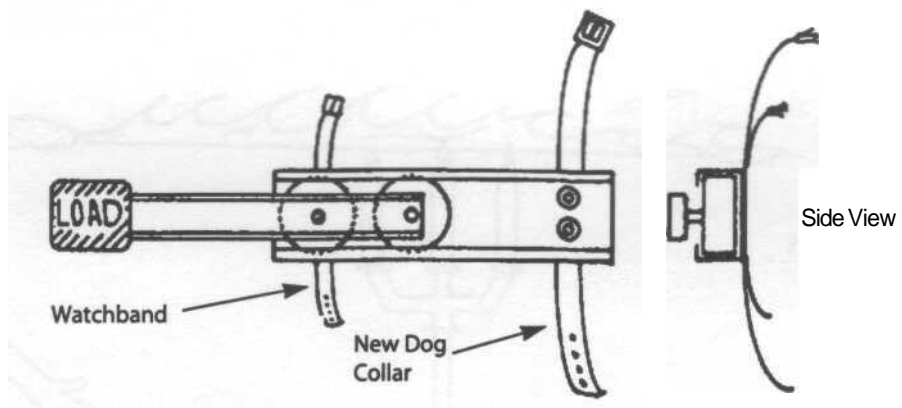

Below is one method of releasing the load, using gravity only, into the hand.

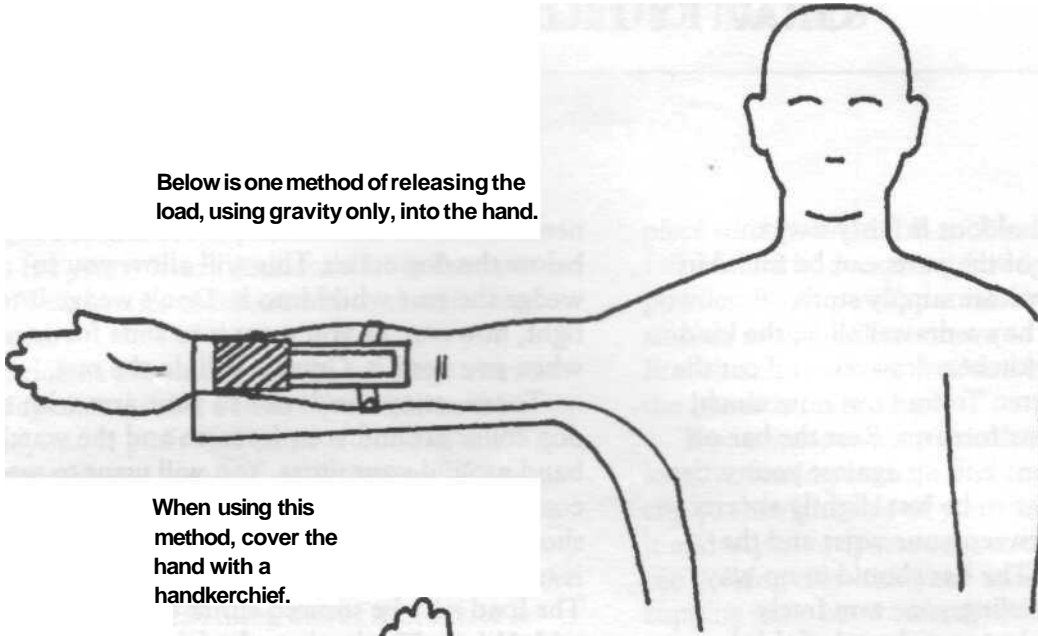

When using this method, cover the hand with a handkerchief.

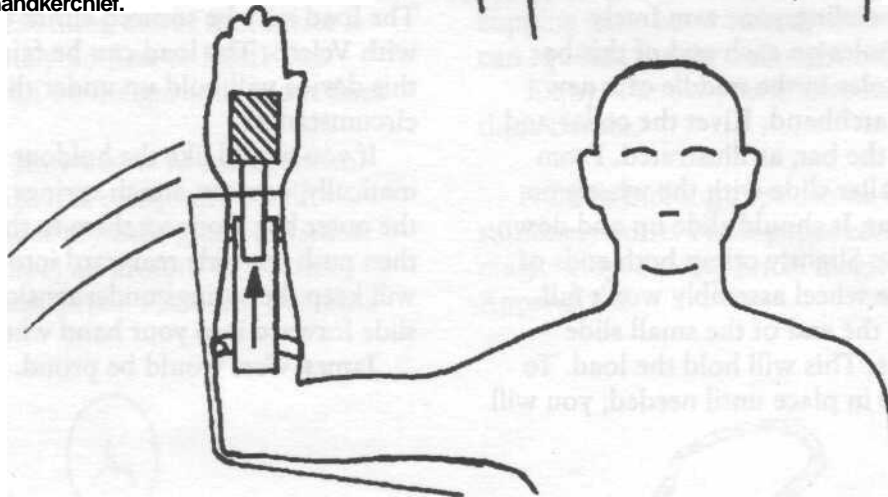

HOT SHOT I

This little device, a favorite of mine, is worth its weight in titanium. Imagine, at any time, being able to produce a huge flame at your fingertips. I have shot a flame more than 20 feet with this device. That's a real attention getter.

The device is, as are all great tricks, very simple to construct. You will need a metal lighter and a nasal spray bottle (the stream type, not the mist type).

First of all, you need to modify the lighter slightly. With tin snips, cut away one side of the grill on the lighter so that when the lighter is lit and tilted on its side the flame is able to stay lit and point upward. With some electrical tape, tape the spray bottle to the lighter as shown in the illustration.

Prior to attaching as above, you will need to load the spray bottle with a flammable filler. Lighter fluid works best, but I have also found 151-proof rum works well in a pinch. To fill the bottle, work a fingernail under the lip of the nasal insert and pull it out of the plastic bottle, then replace the nasal tip like a cork. If the insert won't come out, then you can pour lighter fluid into a cup and squeeze the empty bottle and stick it into the cup, nose first to suck up the fluid. Pull it out and point the nose up; squeeze out the air and repeat the process until the bottle is full.

The other method of filling the spray bottle is to use a syringe. These are not always easy to buy at a drugstore unless you are a diabetic. Go to your local co-op animal feed store and buy them there, no problem. Most pharmacies will also have similar squeeze bottles designed to be easily opened and refilled for less than a dollar.

After you have filled the spray bottle and attached it to the lighter, you are set to perform. To keep the bottle from leaking, place a piece of tape over the hole in the bottle. Or simply place the electrical tape lower on the bottle and lighter setup and replace the original cap on the bottle.

When firing the device, I strongly recommend that you wear a glove. Make sure the bottle is completely full of flammable liquid. This device can be fired more than once if you wipe off excess fluid. The device becomes a danger to you at this point. Close the lighter immediately after you fire it. Be very careful when using indoors. Keep the device well hidden in your hand so no one will go home and duplicate it, especially kids.

Use a lot of caution and common sense. This device will pay for itself time and again.

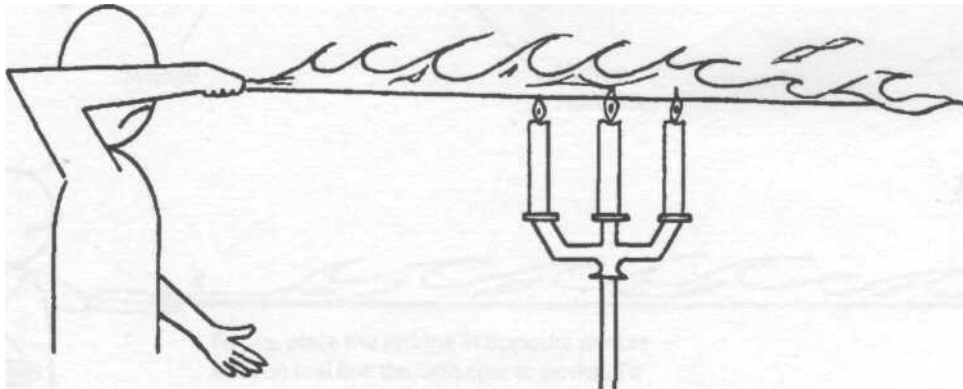

WARNING: THE EFFECTS AND DEVICES IN THIS BOOK ARE EXTREMELY DANGEROUS AND SHOULD BE UNDERTAKEN BY TRAINED PROFESSIONALS ONLY. THIS MATERIAL IS PRESENTED FOR INFORMATION PURPOSES ONLY.

HOT SHOT I

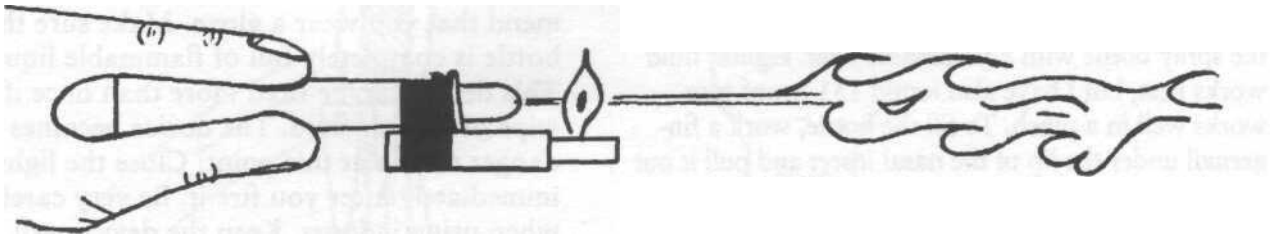
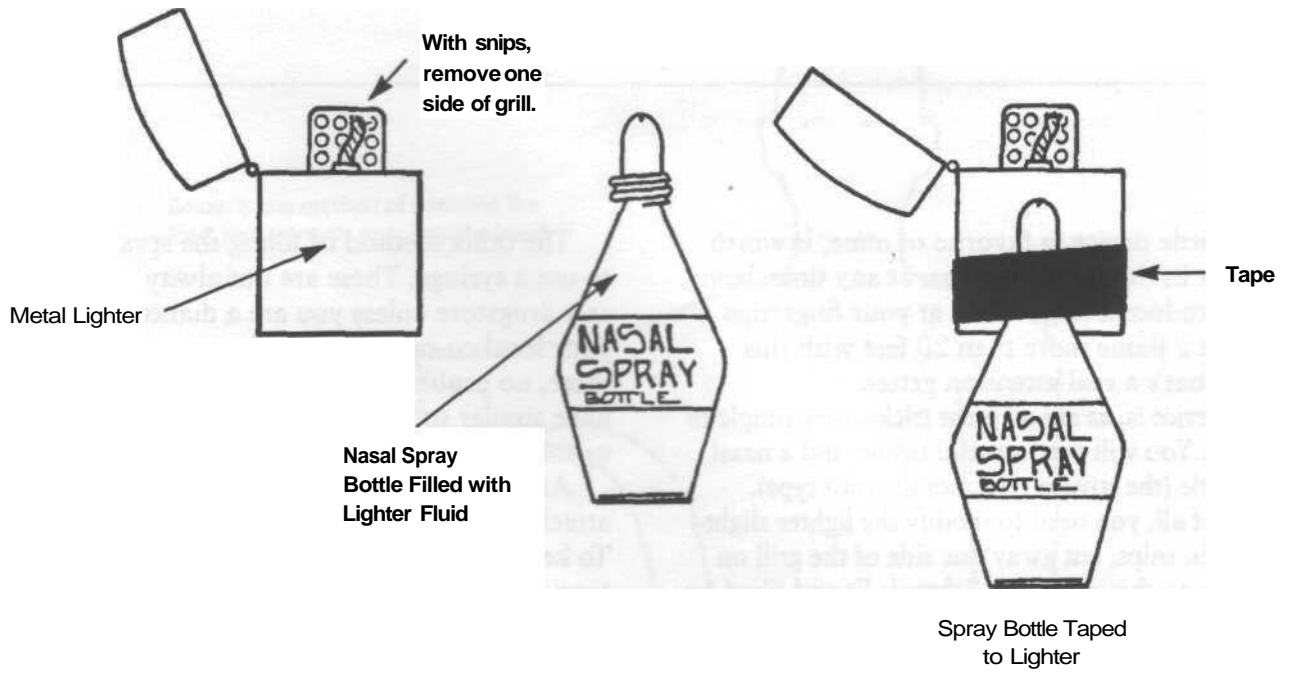

HOT SHOT II

This device produces the same effect as the Hot Shot I: to shoot a stream of fire from your hand.

To construct this device, you need a disposable lighter, a large syringe, a long piece of 1/8-inch plastic surgical tubing, a 4-inch length of brass tubing, and a couple of plastic wire ties or some electrical tape. Using the illustration below, build the device as shown.

Fill the syringe with lighter fluid. Hold the lighter in one hand and put the syringe in the pocket on the side opposite that hand. The surgical tubing runs through the coat behind your back and out your sleeve. Light the lighter, then depress the syringe, forcing out the fuel which is then ignited by the flame.

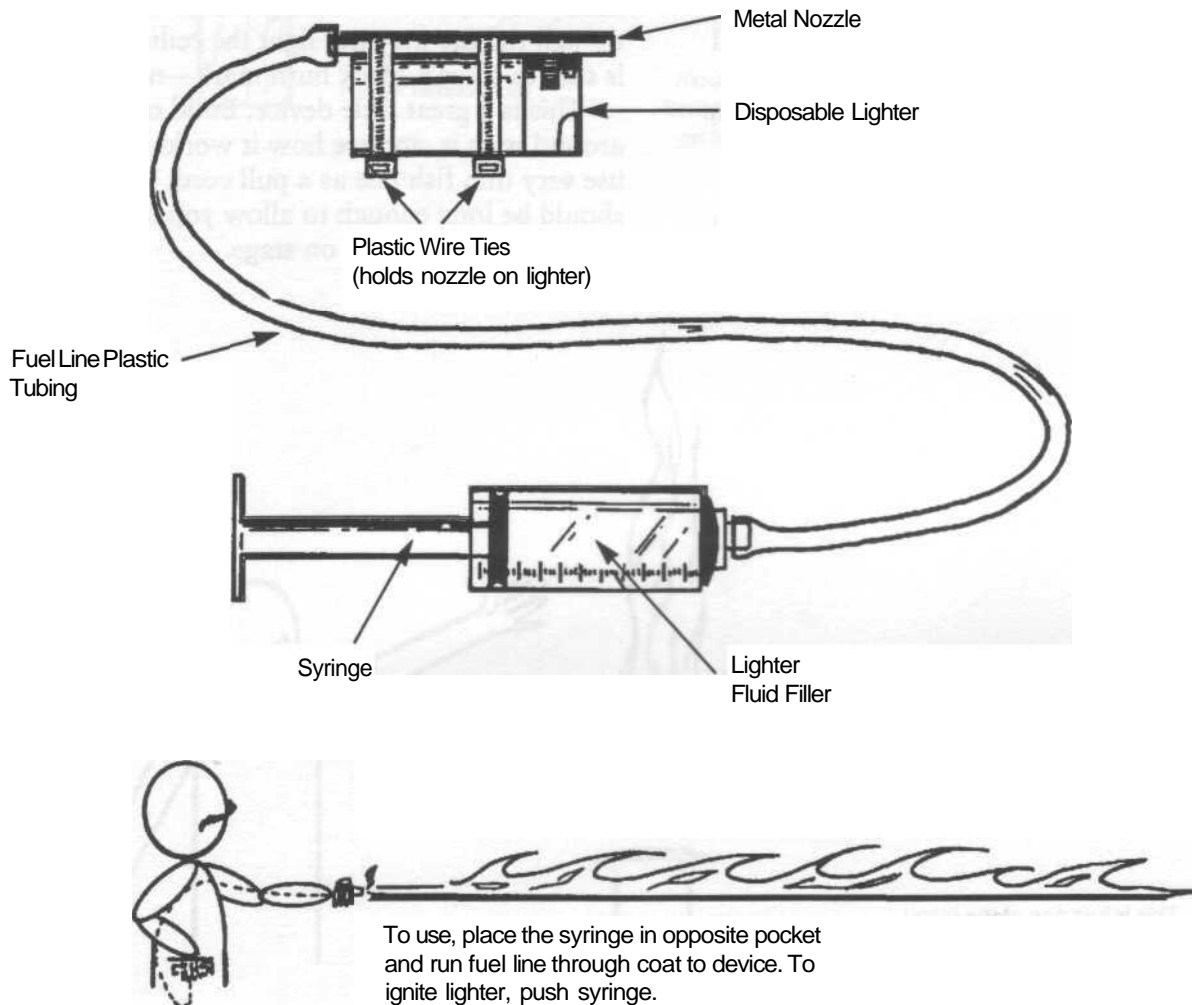

WARNING: THE EFFECTS AND DEVICES IN THIS BOOK ARE EXTREMELY DANGEROUS AND SHOULD BE UNDERTAKEN BY TRAINED PROFESSIONALS ONLY. THIS MATERIAL IS PRESENTED FOR INFORMATION PURPOSES ONLY.

FLASH FIRE

A brilliant flash of fire any time during your act is sure to attract attention. It puts sparkle into any performance and is simple to construct.

To construct, start by boring a slightly oversized 3/4-inch hole through a mousetrap. Also do this to the top board of a wooden frame. Attach the mousetrap to the board so the holes line up. Affix the mousetrap to the board with electrical tape or small nails.

Open a 12-gauge shotgun shell and remove the lead shot. Replace it with 3/4-inch balls of flash paper and close up the shell. Insert the shell through the holes in the mousetrap/wooden frame setup. Bend the fly bar on the mousetrap to form a point so it will strike primer on the shotgun shell. Cut a fly bar release peg out of a 1/4-inch wooden dowel. Attach this to the mousetrap as shown and pull back the fly bar.

Allow the fly bar to be held back by the peg. Also have a pull cord attached to the peg. At this point the device is ready to be fired, so use caution.

The device should be hidden in something to conceal how it works. The illustration shows it hidden in a top hat. I realize that few people use top hats in their act any more. It is just shown as an example only. I think hiding it behind a large enough prop would work well.

Make sure, before you use the flash fire device in any room, that the ceiling is high enough. Although the fire may not light the ceiling on fire, it is sure to leave a black burn mark—not good PR.

This is a great little device. Build one, fool around with it, and see how it works for you. I use very thin fish line as a pull cord. The line should be long enough to allow you to fire the device from anywhere on stage.

This is just one of the many applications of this device.

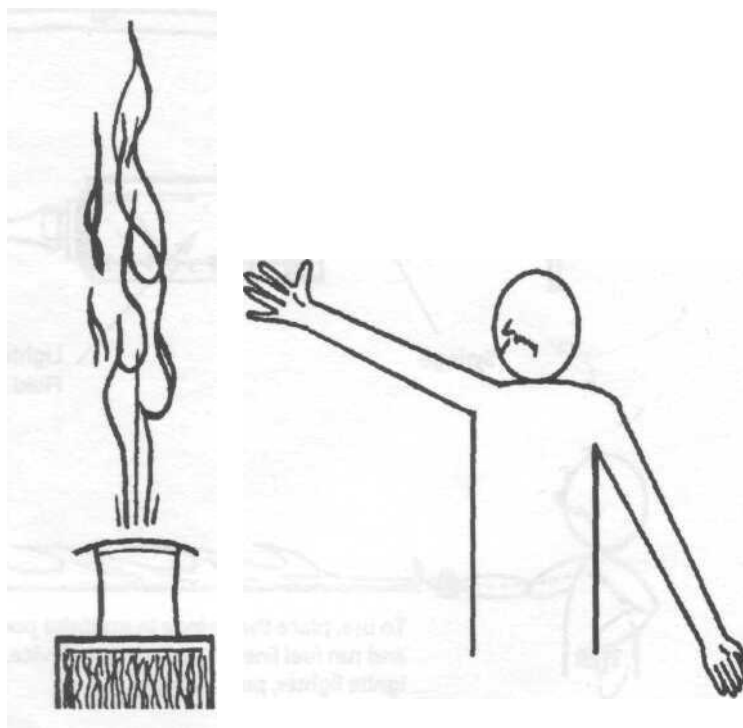

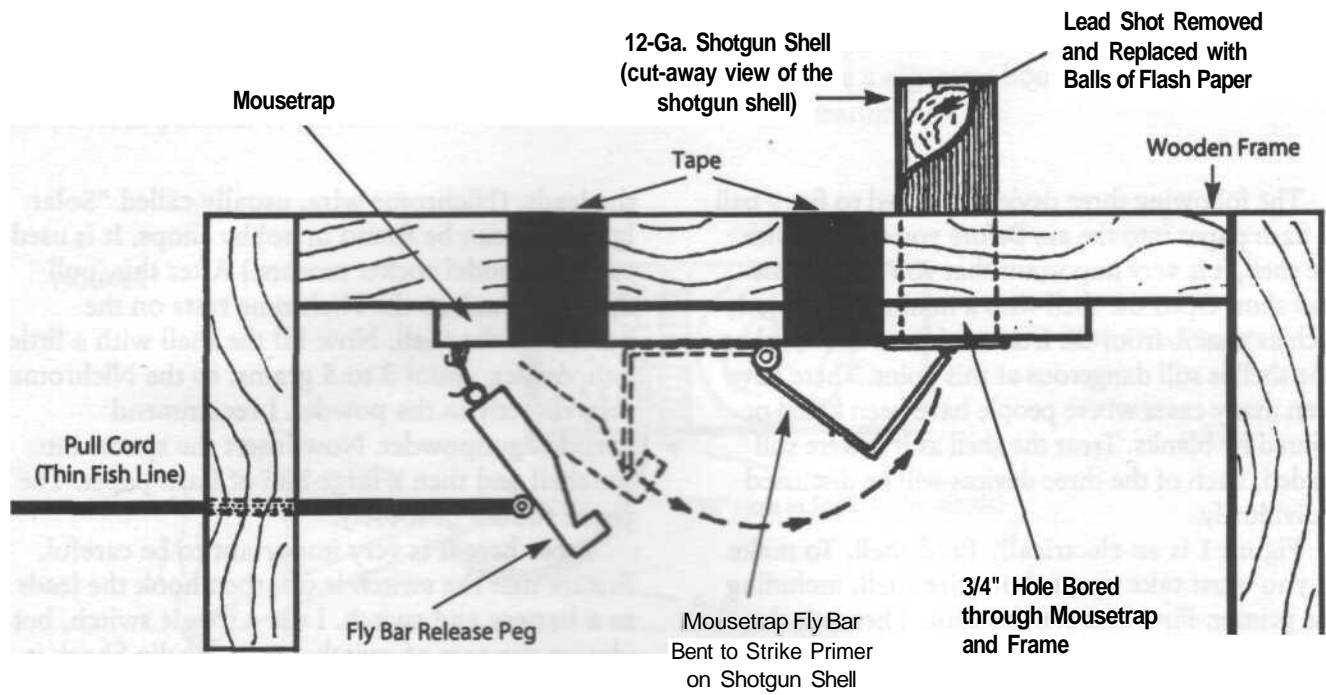

WARNING: THE EFFECTS AND DEVICES IN THIS BOOK ARE EXTREMELY DANGEROUS AND SHOULD BE UNDERTAKEN BY TRAINED PROFESSIONALS ONLY. THIS MATERIAL IS PRESENTED FOR INFORMATION PURPOSES ONLY.

SHOTGUN-SHELL DEVICES

The following three devices are used to fire a ball of flash paper into the air. Before you tamper with the shell, it is very important that you remove the lead shot. Open the shell with a nonmetallic object, such as pencil, from the front and pour out the shot. The shell is still dangerous at this point. There have been many cases where people have been killed or injured by blanks. Treat the shell as if it were still loaded. Each of the three devices will be discussed individually.

Figure 1 is an electrically fired shell. To make it, you must take apart the entire shell, including the primer. First remove the shot. Then put the shell in a shotgun and fire it. This safely disables the primer. Next remove the dead primer by pushing it out from the inside with an ice pick, thus leaving a hole in the shell. Then thread the wire leads through this hole and out the other end. Now hook a piece of fine Nichrome wire to

the leads. (Nichrome wire, usually called "Solar Igniters," can be found in hobby shops. It is used to ignite model rocket motors.) After this, pull the leads back so the Nichrome rests on the bottom of the shell. Now fill the shell with a little gunpowder, about 3 to 5 grams, so the Nichrome rests directly in the powder. I recommend Pyrodex gunpowder. Now insert the spacer into the shell and then a large ball of flash paper. The paper should fit loosely.

From here it is very important to be careful. Ensure that the switch is off, then hook the leads to a battery and switch. I use a toggle switch, but almost any sort of switch works. Radio Shack is your best source for switches. You may want to fire the shell by placing it in a 3/4-inch pipe with a pipe cap. The leads will come through a small hole in the pipe cap and then connect to the battery and switch.

FIGURE 1

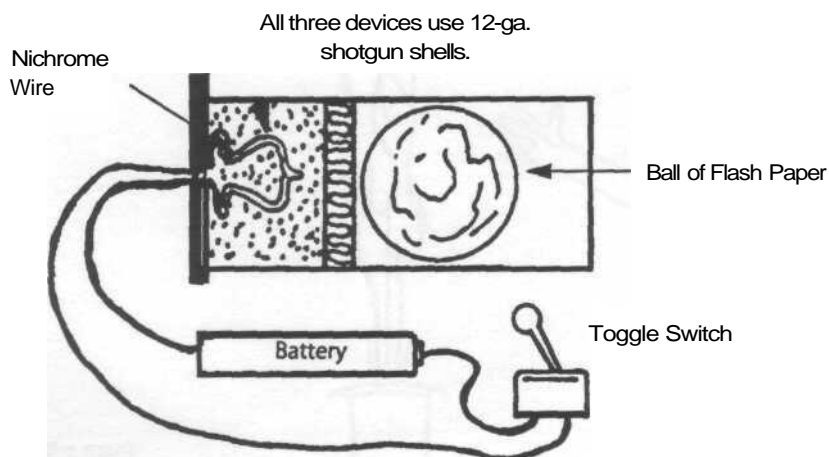

Figure 2 is simple to construct. After removing the lead shot and inserting the flash paper, you will need to poke a small hole in the plastic part of the shell. Use a nonmetallic object such as a pencil. Poke the hole just above the metal into the gunpowder portion of the shell. Now insert a

fuze directly through the hole into the powder. All that is left is to light the fuze and set it upright. You may wish to have some sort of a timer to light the fuze. A simple 5-to-7 minute fuze can be a cigarette hooked to the fuze, as in the illustration.

FIGURE 2

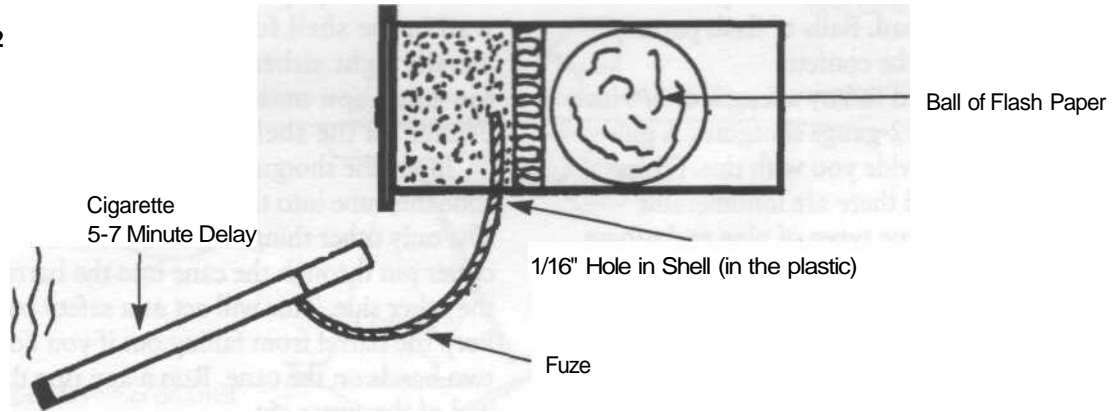
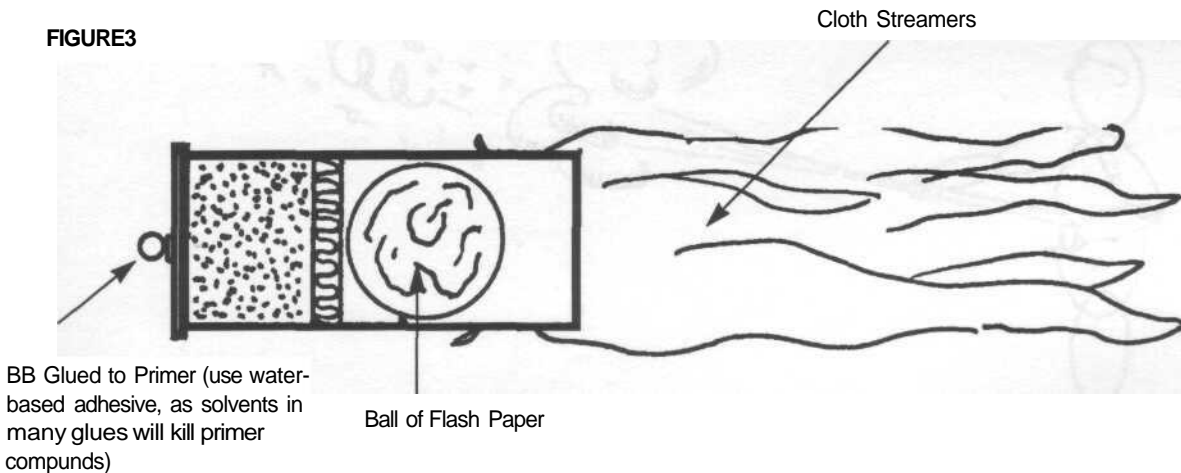

Figure 3 is a device that is to be thrown or dropped on a hard, flat surface. Construct the basic device as above. You then glue a BB or small ball bearing to the primer and connect cloth streamers to the other end. To detonate the de-

vice, throw the shell up in the air and it should land on the BB, which will fire the shell. This device is dangerous because you do not know in which direction or at which exact angle the shell will fire. *Be careful.*

FIGURE 3



BALLISTIC CANE OR UMBRELLA

This device could be incorporated either into a cane or umbrella. In the illustration the performer is shown firing a confetti load. Balls of flash paper could be substituted for the confetti.

To construct, you need to buy a length of 3/4-inch seamless tubing used in 12-gauge shotguns. A gunsmith will be able to provide you with this. (Tolerances are fairly loose and there are innumerable dimensional specs for some types of pipe and tubing, so the best solution might be to take the shell in question down to the pipe shop and try it for fit. If it fits, fine; if it's too snug, take the pipe or tubing to a brake shop and have someone use a brake cylinder hone to slightly enlarge the chamber). It should be about 20 inches long.

With this piece of tubing, the rest is easy. You also need a heavy aluminum or steel cane, which can be bought at a medical or hospital supply shop, and a breech plug that will fit into the cane and be retained in place by screws through the wall of the aluminum or steel cane and into the breech plug, as illustrated. Open the shotgun shell, remove the lead shot, and

insert confetti or flash paper as the load. If you choose flash paper, you will need to remove the wad in the shell for guaranteed ignition. It will usually light either way, but I always remove the wad. You must also glue or tape a BB to the primer on the shell.

Insert the shotgun shell into the barrel and then slide this tube into the cane, and you're ready to go. The only other thing that I advise is to incorporate a cotter pin through the cane into the barrel and out the other side. This will act as a safety pull pin and keep the barrel from falling out if you do not have two hands on the cane. Run a key ring through the end of the cotter pin.

The ballistic cane uses a sliding "trombone principle" to fire. When you slide the barrel sharply back against the breech plug, the BB glued to the primer fires the shotgun shell.

CAUTION: Never fire this device at or in the direction of spectators. Even with flash paper or confetti, this device is still a gun and will cause serious injury at close range.



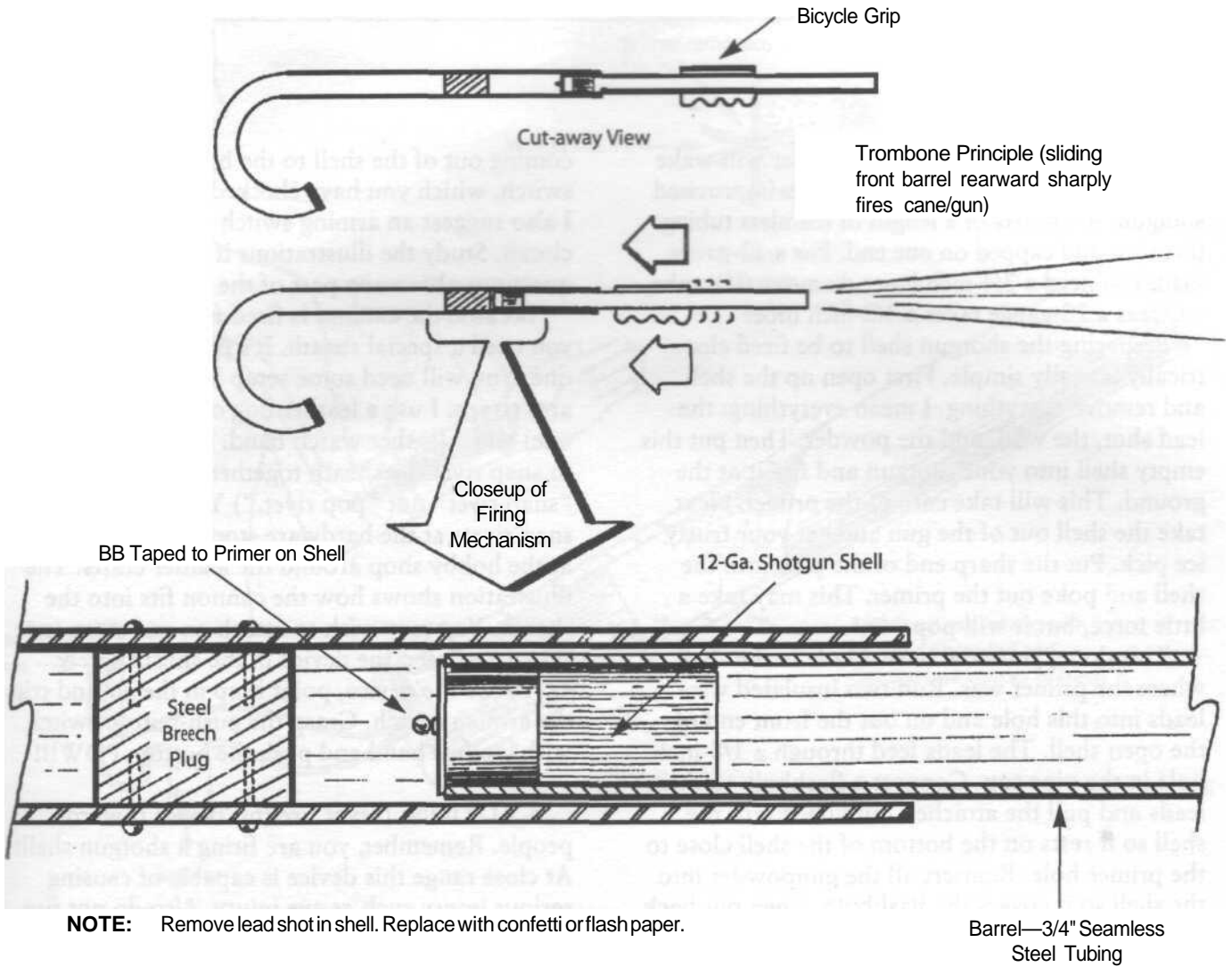

WARNING: THE EFFECTS AND DEVICES IN THIS BOOK ARE EXTREMELY DANGEROUS AND SHOULD BE UNDERTAKEN BY TRAINED PROFESSIONALS ONLY. THIS MATERIAL IS PRESENTED FOR INFORMATION PURPOSES ONLY.

SLEEVE CANNON

This wonderful little crowd pleaser will wake up any act. The cannon is basically an improvised shotgun. It consists of a length of seamless tubing threaded and capped on one end. For a 12-gauge load, you need a 3/4-inch inner-diameter (ID) tube, whereas a 20-gauge takes a 1/2-inch tube.

Preparing the shotgun shell to be fired electrically is really simple. First open up the shell and remove everything. I mean everything: the lead shot, the wad, and the powder. Then put this empty shell into your shotgun and fire it at the ground. This will take care of the primer. Next take the shell out of the gun and get your trusty ice pick. Put the sharp end of the pick into the shell and poke out the primer. This may take a little force, but it will pop out.

This done, you now have a hole in the shell where the primer was. Run two insulated wire leads into this hole and on out the front end of the open shell. The leads feed through a 1/8-inch hole in the pipe cap. Connect a flashbulb to these leads and pull the attached bulb back into the shell so it rests on the bottom of the shell close to the primer hole. Reinsert all the gunpowder into the shell so it covers the flashbulb. Then put back the wadding. In place of the lead shot, put confetti and paper streamers. Attach these leads

coming out of the shell to the battery and firing switch, which you have checked to ensure it's off. I also suggest an arming switch somewhere in the circuit. Study the illustrations if you have any questions about any part of the above procedure.

Because the cannon is fired from the forearm, you need a special sheath. It's pretty easy to make one. You will need some scrap leather and two arm straps. I use a leather dog collar (yes, a new one) and a leather watch band. You will also need to snap rivet the sheath together. (Read that "snap rivet" not "pop rivet.") You will not find snap rivets at the hardware store. Look for them at the hobby shop around the leather crafts. The illustration shows how the cannon fits into the sheath. You may wish to attach an end strap (not shown) to keep the device in the sheath safely.

To fire the device, point it up in the air and trip the arming switch. Grasp the push-button switch with the free hand and push the button. POW!!!

CAUTION: Never fire this device toward people. Remember, you are firing a shotgun shell! At close range this device is capable of causing serious injury such as eye injury. Also do not fire this device above people's heads. The spread pattern is the same as any shotgun shell.

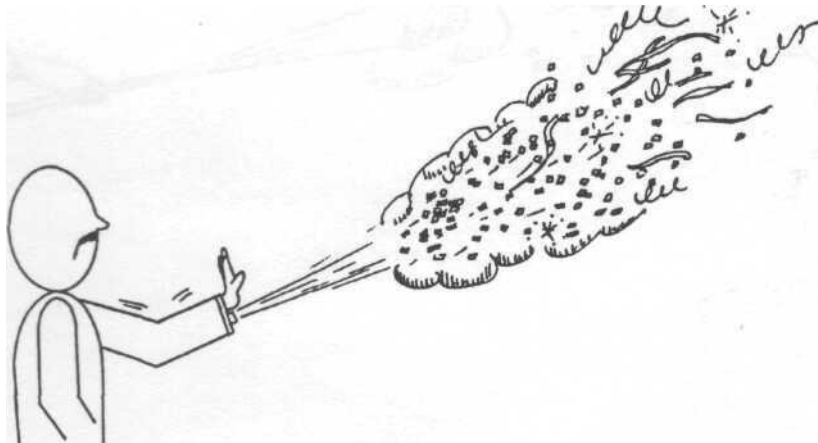

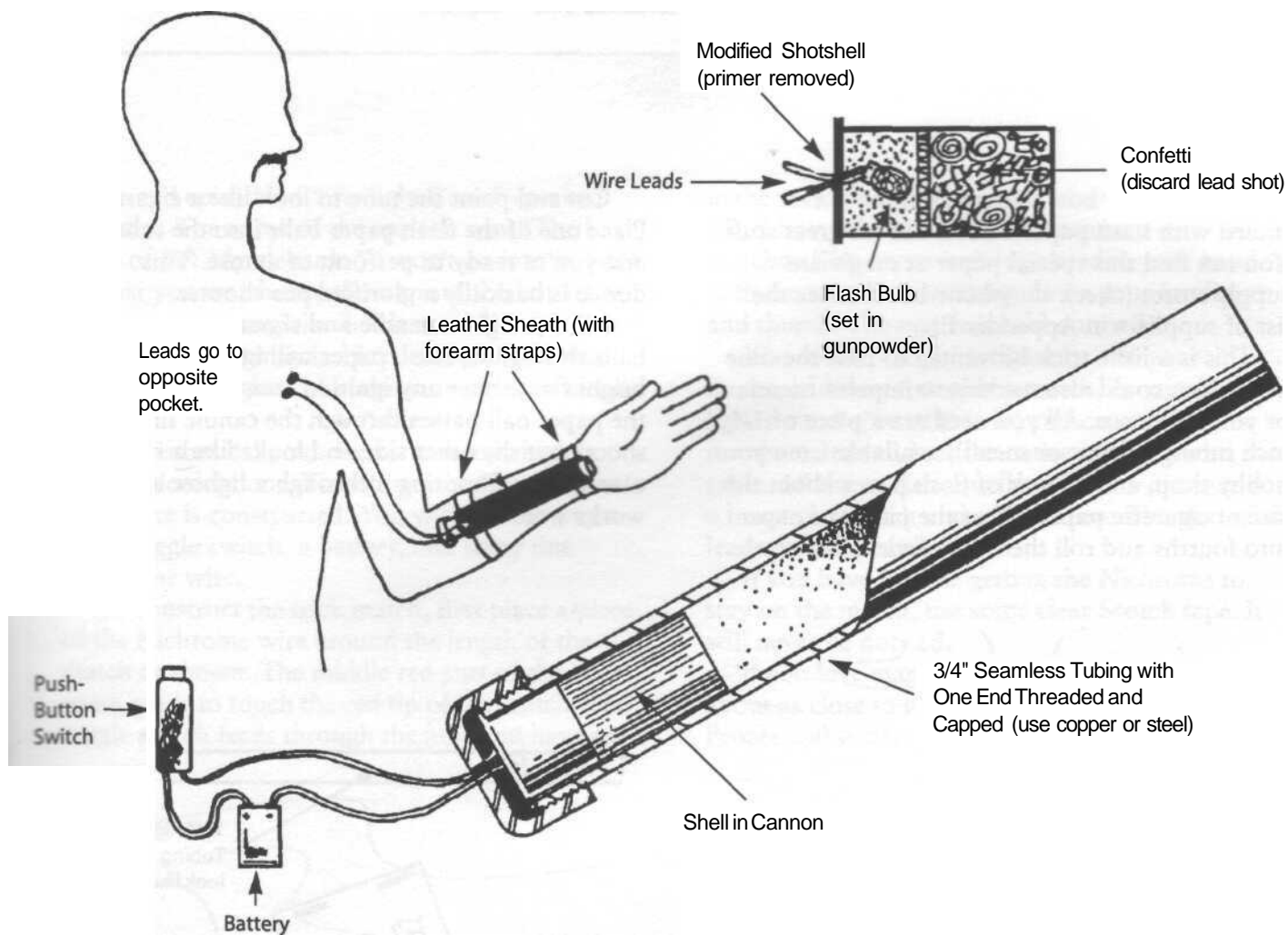

NOTE: The odds are good that standard-dimension 3/4-inch seamless tubing is close enough to work here, but if you have problems fitting the shell into the pipe, have the pipe modified in a machine shop or simply have a gunsmith thread one end of a piece of 12-gauge steel bore.

SPIT FIRE

I don't know how many of you have ever fooled with flash paper before, but it's great stuff. You can find this special paper at magicians supply stores (check the phone book or see the list of suppliers in Appendix E).

This is a little trick I invented to pass the time away. You could also use this to impress friends or your audience. All you need are a piece of 1/4-inch tubing (plastic or metal), available from your hobby shop, and a book of flash paper about the size of cigarette papers. Tear the pieces of paper into fourths and roll them into little balls.

Cut and paint the tube to look like a cigarette. Place one of the flash paper balls into the tube, and you're ready to perform or amuse. This device is basically a glorified pea shooter.

I like to light a candle and shoot the paper balls through it. Flash paper will ignite into a bright flame near any ignition source. As soon as the paper ball passes through the candle flame, it shoots out the other side and looks like a miniature meteor. Shooting it through a lighter also works well.

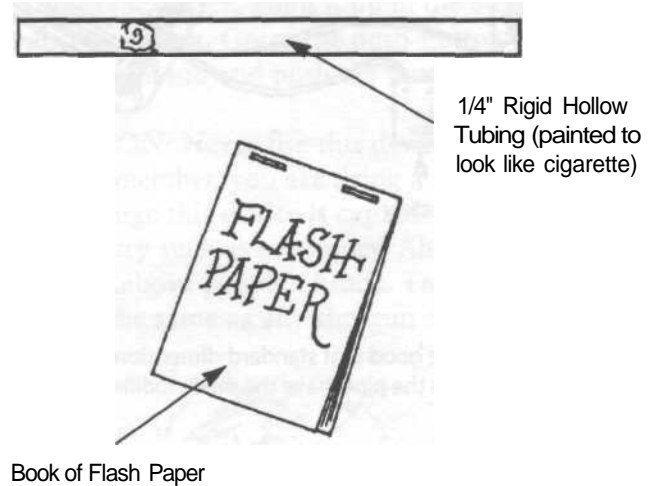
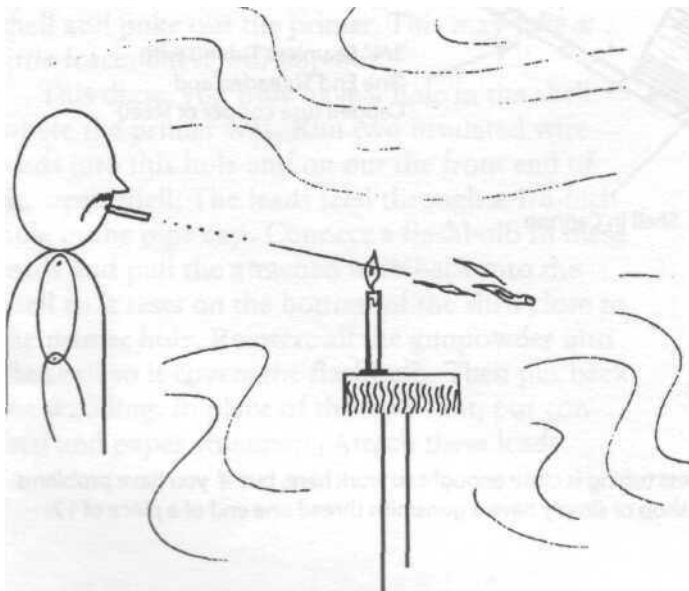

SELF-LIGHTING MATCH

An old episode of "Twilight Zone" sparked this idea. The name of the episode was "The Last Rites of Jeff Myrtlebank." I won't go into it, but I suggest you watch this show to see the impact of this trick. The magician holds an ordinary wooden kitchen match. He concentrates on the match, and it lights! No false moves. It's as clean as that.

This is basically an electric match, which is used in demolitions. The illustration shows how the device is constructed. You will need to buy a small toggle switch, a battery, and some fine Nichrome wire.

To construct the trick match, first place a piece of the Nichrome wire around the length of the match as shown. The middle red part of the Nichrome needs to touch the red tip of the match. The toggle switch feeds through the hole you have cut

in the match box. The battery also fits into the matchbox, which, by the way, contains no matches. This entire unit is palmed in your hand with the wire leads running down your forefinger and thumb. The match is held normally.

You could first put a cigarette into your mouth and then fire up the match, or you could light a candle, etc. Once lit, you can easily blow out the match and set the entire unit down on the table. All the audience will see from a distance is a burnt-out match and a matchbox. The thin wire leads will not be noticed.

If you have trouble getting the Nichrome to stay on the match, use some clear Scotch tape. It will never be noticed.

If you love magic, this trick is for you. It's about as close to real magic as you will ever come. People will swear you're an agent of the devil.

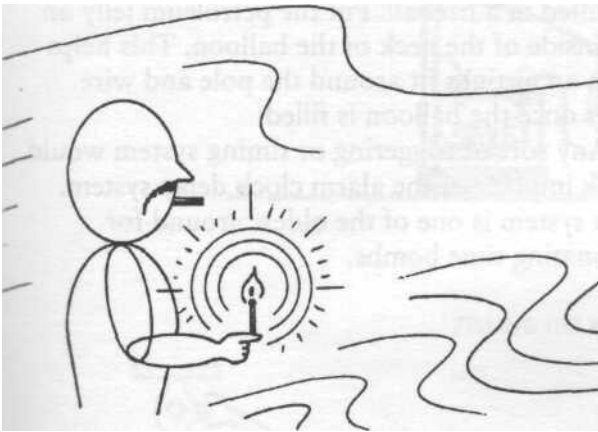

Holdup a match, and without moving your hand, the matchlights all by itself.

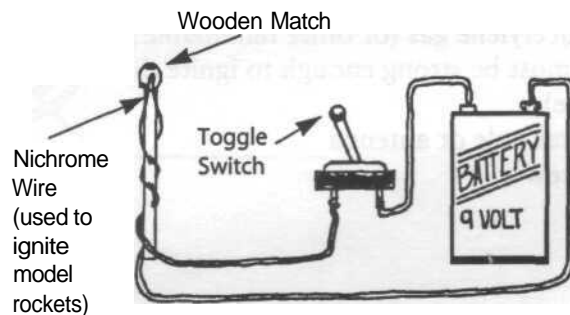

Fit Unit in Match Box



WARNING: THE EFFECTS AND DEVICES IN THIS BOOK ARE EXTREMELY DANGEROUS AND SHOULD BE UNDERTAKEN BY TRAINED PROFESSIONALS ONLY. THIS MATERIAL IS PRESENTED FOR INFORMATION PURPOSES ONLY.

EXPLODING BALLOONS

This is one of the most dangerous items in this book. Let me start by saying that under no circumstances should this device be used indoors. A friend of mine who is a welder tested this device for me and made the mistake of testing it in his shop. Upon detonation, a huge fireball resulted that blew out the windows in his shop and almost set his roof on fire. He damaged his hearing and almost went to jail for building a bomb. Enough of my preaching against my little infernal machine.

This device is for use on an open outdoors stage only. To build it, you need only a few innocent items.

- Large round balloon
- Flash cube
- Alarm clock
- Wire leads with alligator clips
- Book of paper matches
- Petroleum jelly
- Tank of acetylene gas (or other flammable gas)
- Battery (must be strong enough to ignite the flash cube)
- Long metal pole or antenna
- Wood screw

The instructions on the illustration explain how this device works. Start by making the flash cube ignitor. Remove the plastic shell from it and glue match heads around the bulb. Discard the shell. Tape the pole to the large battery. Glue or tape the flash cube to the top of the pole. Attach the leads to the cube with the alligator clips and run the leads down the pole.

Drill a hole in the clear plastic clock face. Insert the wood screw in this hole but don't let it reach the clock face itself. Prior to this, take off the plastic clock face and remove the hour hand if you want a minute delay or the minute hand if you want an hour delay. Connect the rest of the wiring to make a complete circuit.

At the last minute, inflate the balloon with acetylene gas. Never transport filled balloons in your car. If a filled balloon exploded in your car from a spark (cigarette, etc.), your car would be engulfed in a fireball. Put the petroleum jelly on the inside of the neck of the balloon. This helps form an airtight fit around the pole and wire leads once the balloon is filled.

Any sort of triggering or timing system would work in place of the alarm clock delay system. This system is one of the oldest around for detonating time bombs.

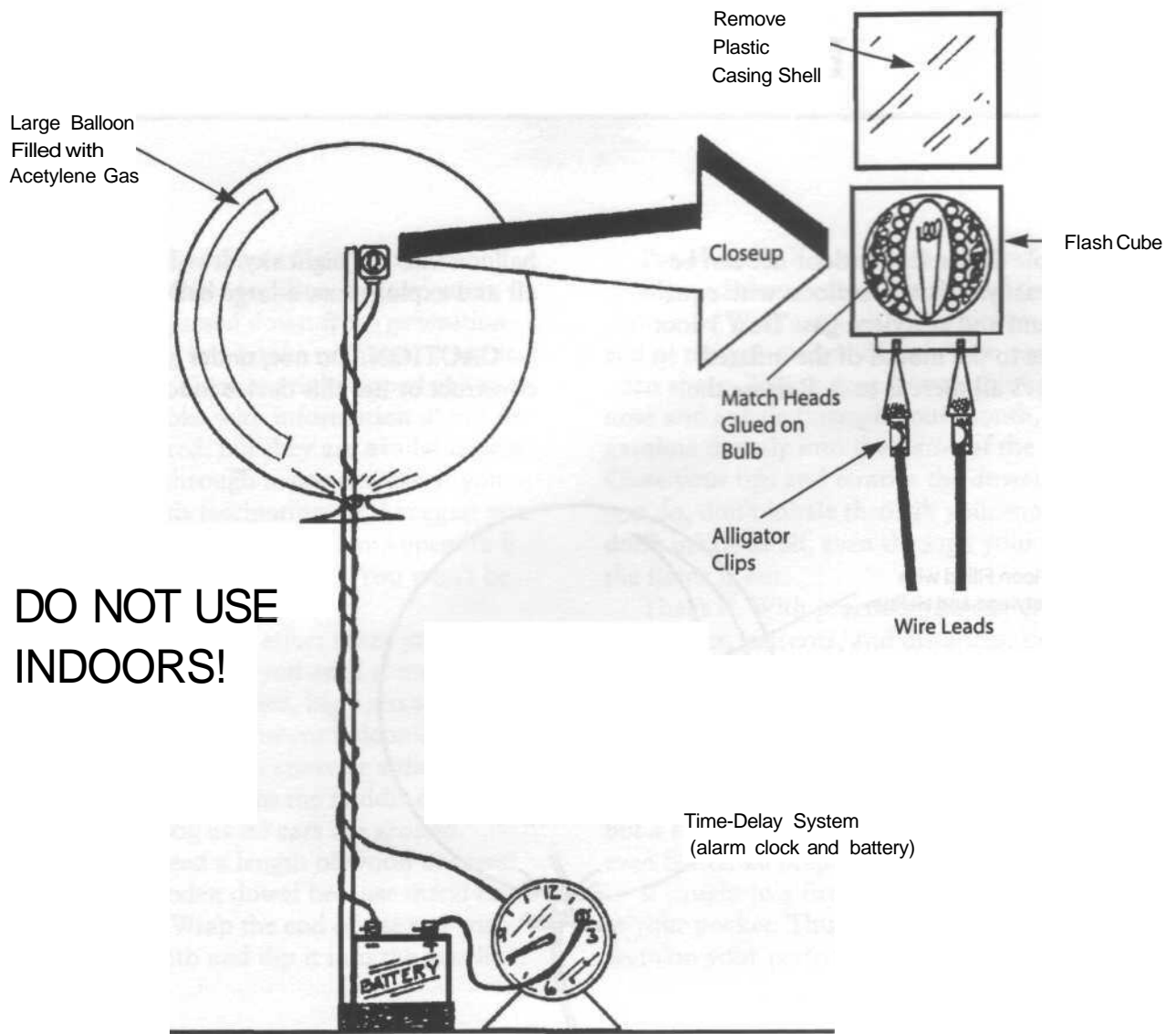

FILLING THE BALLOON

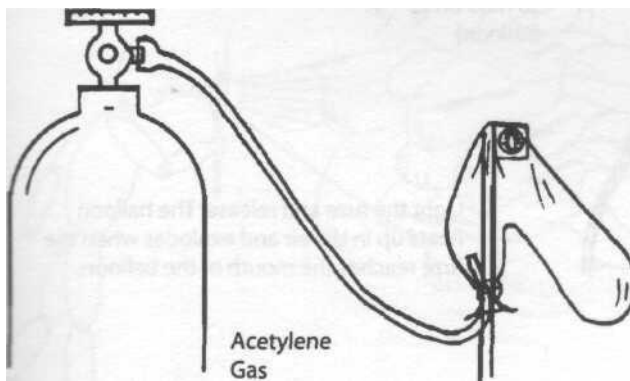

WARNING: THE EFFECTS AND DEVICES IN THIS BOOK ARE EXTREMELY DANGEROUS AND SHOULD BE UNDERTAKEN BY TRAINED PROFESSIONALS ONLY. THIS MATERIAL IS PRESENTED FOR INFORMATION PURPOSES ONLY.

EXPLODING BALLOONS II

This simple device for outdoor use can be made quite easily. Inflate a balloon with equal parts of helium and acetylene gas. Tie a 3-foot length of fuze to the mouth of the inflated balloon. That's all there is to it. Release the

balloon into the night sky. It will float up into the air and explode into a large ball of flames.

CAUTION: Do not, under any circumstances, construct or use this device indoors.

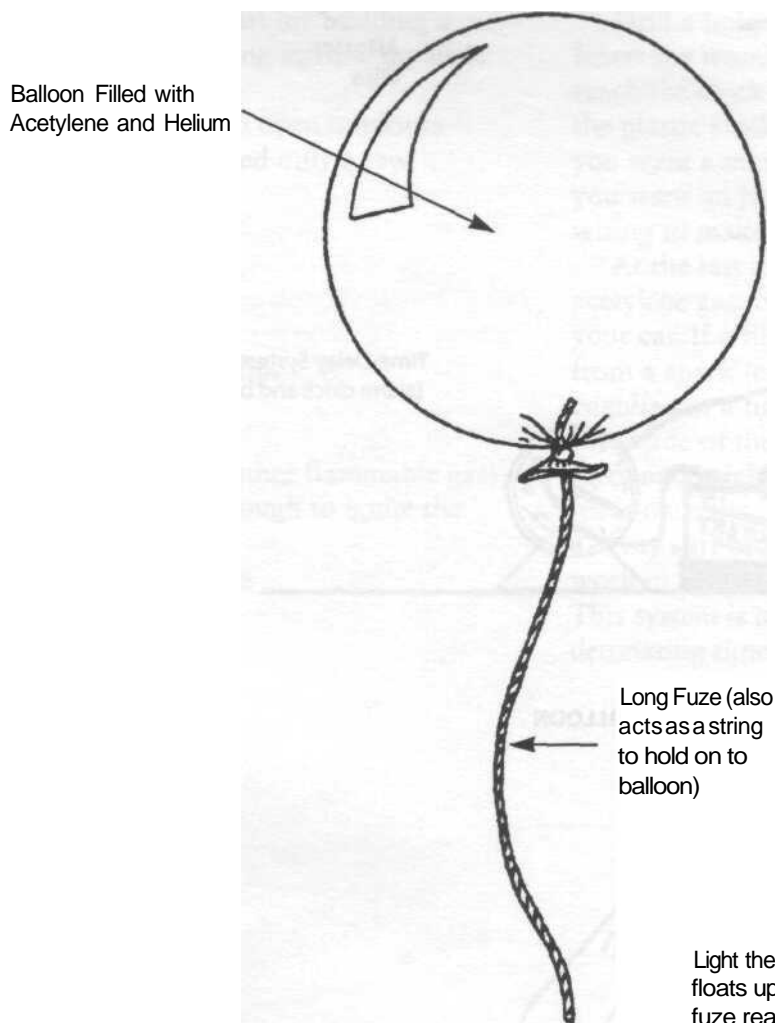

HUMAN BLOWTORCH

One of the oldest forms of magic, fire eating has intrigued audiences for thousands of years. Its secrets have been passed down from generation to generation. Very few books on magic cover it, and, as usual, magicians are tight-lipped about it. Recently a few books with information about fire eating have appeared, but they are available only to magicians and through magic dealers. If you want to take up this fascinating art, I suggest you contact the magic dealers located in Appendix E and buy some of the books listed. You won't be disappointed.

The human blowtorch effect takes practice and lots of guts. To do it, you need some unleaded gasoline and a nice, big open space. Small backyards and apartment balconies won't do! An outdoor basketball court or a dirt field will work. Even standing in the middle of your street is okay as long as no cars are around.

You will also need a length of wood or metal tubing. I use a wooden dowel because metal heats up pretty quickly. Wrap the end of the rod with strips of cotton cloth and dip it into the gasoline.

Put about half a mouthful of gasoline in your mouth and move out of the area of the gas container. With a match, not a lighter, light the end of the gas-soaked dowel. Turn toward the open space. Take a deep breath through your nose and exhale through your mouth, spitting the gasoline directly into the flame of the dowel. Close your lips and remove the dowel. Whatever you do, don't inhale through your mouth! In fact, don't inhale at all, even through your nose, until the flame is out.

That's it. With practice, you can create various flame sizes, patterns, and distances. Enjoy!

CAUTION: Always have two methods to extinguish a fire when performing this because, at some point, you will have an accident; every performer does. Two fire extinguishers will work, but a fire extinguisher and swimming pool are even better. Be prepared!

If caught in a fire, butane lighters will explode in your pocket. Thus, don't use them or have them on your person when performing this trick.

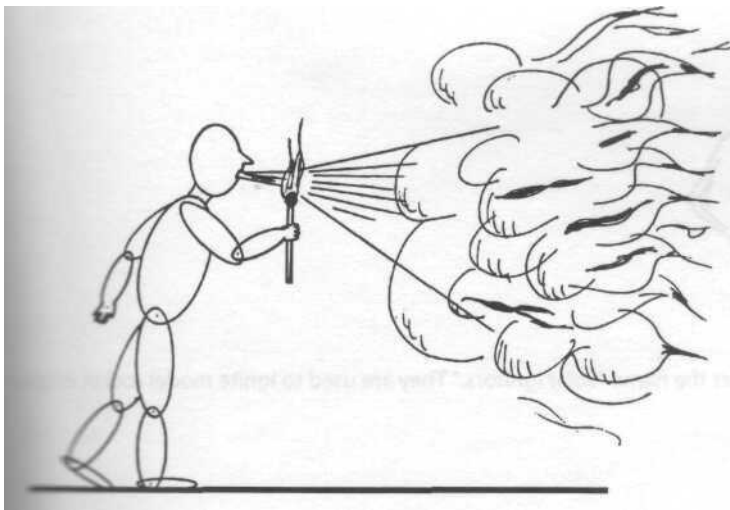

Performer is using unleaded gasoline as the flammable substance.

Don't inhale!

BOTTLE ROCKET GUN

This device is great for any outdoor performances, not just for the Fourth of July. I have used this to entertain many audiences, and they always enjoy it.

The entire unit is constructed from metal (brass or aluminum) pipe fittings, a toggle switch (which acts as a trigger) and a 9-volt battery, a piece of Nichrome wire (see self-lighting match

for info on this stuff), and some wire leads.

Attach all the components to the pipe-shaped gun as shown. Attach the Nichrome wire to the fuze of the bottle rocket and you're set to go. Point the gun up in the night sky and fire.

Under no circumstances should this device be used to chase cats up an alley at midnight.

**FOR OUTDOOR
USE ONLY!**

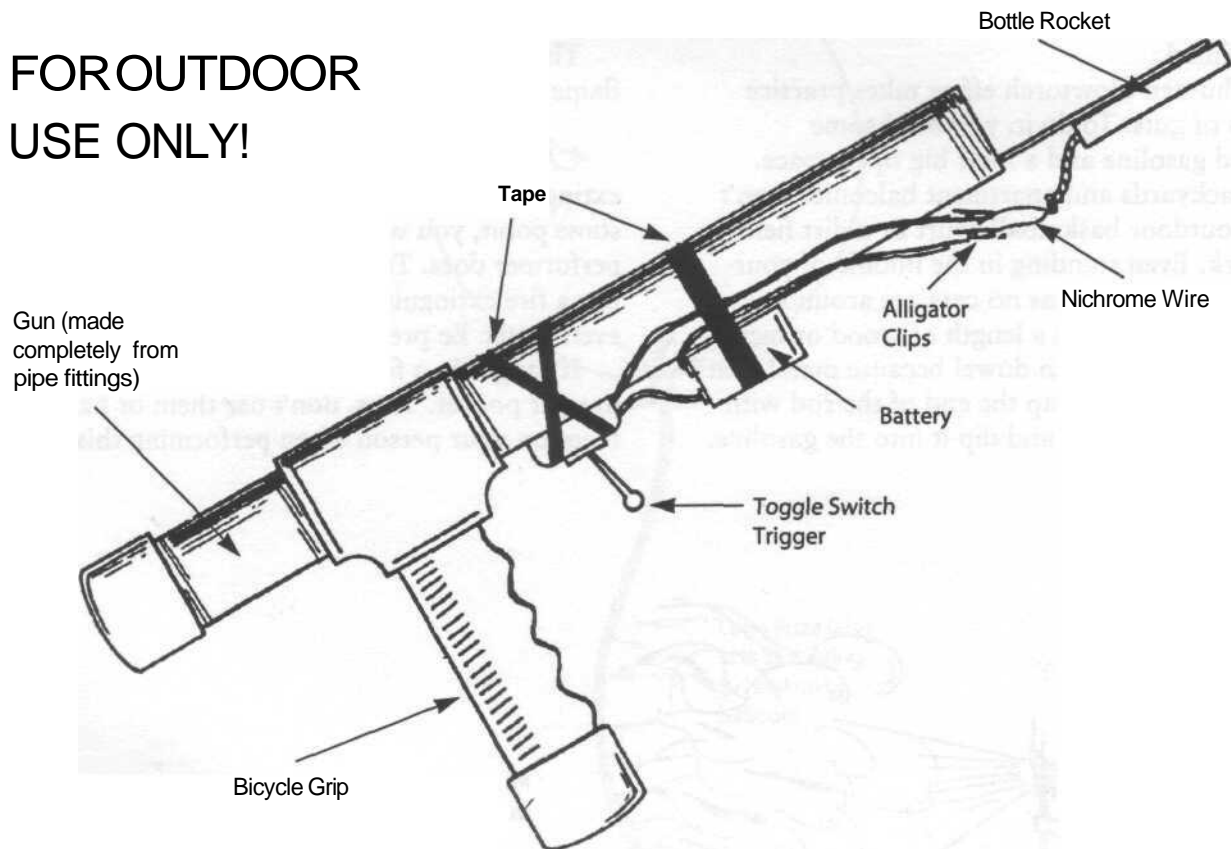

NOTE: Nichrome wire is readily available in hobby shops under the name "Solar Igniters." They are used to ignite model rocket engines.

DIGITAL TIME-DELAY WEAPON-FIRING SYSTEM

This method was developed to fire a weapon with a time delay of up to 99 hours and 99 minutes. The system uses a countdown timer that has been modified slightly so that an additional electric circuit may be incorporated. It is very simple and requires no extensive knowledge of electronics.

The illustration shows how to make one. First you remove the back of the countdown timer. Next, cut the beeper from its leads and connect the wires from the relay and battery to these leads on the timer and the leads on the opposite side of the relay to the servoreceiver box. Mount the microswitch on the side of this box so the servo-arm will be pressing down on the microswitch

lever, thus keeping it depressed. Connect the wires from the microswitch to the electric door lock actuator on the barrel of the pistol. Use the setup shown on page 24 for connecting the electric door lock actuator to the pistol.

The "workings" description in the illustration gives all the info needed for firing this system.

The relay used can be found at Radio Shack. Any hobby shop that sells remote-controlled aircraft, cars, and boats should have the servo-mechanism and receiver.

CAUTION: Always use blanks in the weapon, never live ammunition.

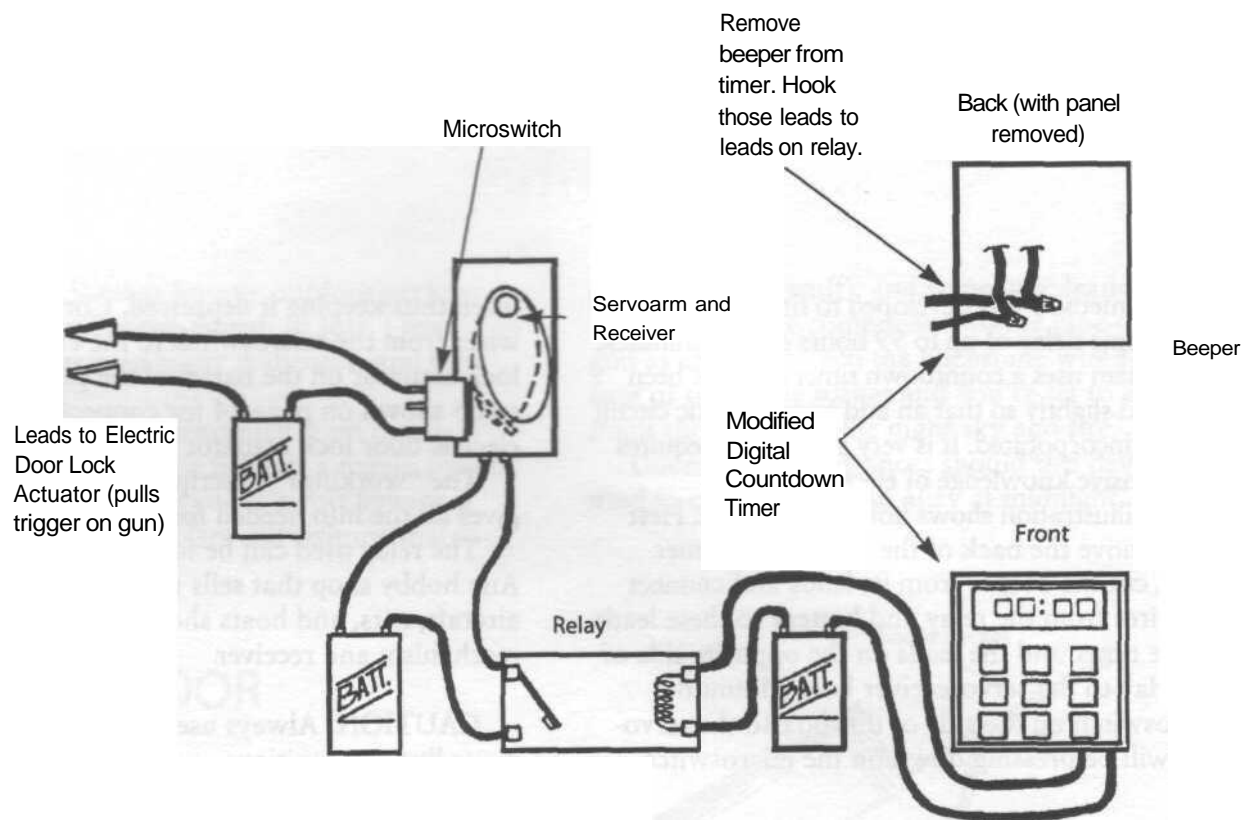

WORKINGS

1. Always test your circuits.
2. Timer counts down to zero, thus completing that circuit.
3. Relay opens.
4. Servo loses power and releases depressed microswitch.
5. Microswitch, which had been held in off position, is now open and on.
6. With microswitch on, the electric door lock actuator is activated and pulls trigger on gun.
7. Gun fires.
8. Most countdown timers have up to 99-hour and 99-minute delay.

PSYCHOKINETIC SCRAMBLER

This heavy-duty radio-jamming device, invented during World War I, was the only radio-jamming equipment in existence at that time. I have used one to jam police and fire frequencies, and radio and television reception presents absolutely no problem.

The jammer uses a Model "T" spark coil. At first you may ask, "Where in the world can I find one of these?" They're easier to find than you may think. I can usually find them at science supply stores, ham radio shops, or vintage-car dealers. Or you can always order one from the J.C. Whitney Company (P.O. Box 8410, Chicago, IL 60680). The coil costs about \$40 at this writing.

The unit illustrated is built into a wooden frame that fits into a briefcase or suitcase. Two holes are drilled into the top of the case to attach the two antennas. The illustration shows how to wire the jammer; the only thing not illustrated is the fact that the unit must be grounded. Easy enough.

This device's uses in magic should be obvious, but I will explain anyway. You mentalists probably figured this out already. Briefly, you have an assistant in another room with the jammer. At the agreed-upon time, you turn on someone's TV or radio. You pretend to concentrate your mental powers on it, and, all of a sudden, the reception is drastically disrupted.

You attribute this to the powerful vibrations your brain emits.

If you really want power, connect this device to a television tower. Set the spark gap at a large arc. You will blow away TV and radio reception for several blocks. Radio Shack has all the equipment you need to build a nice tower.

Oh, by the way, this device is illegal to build (Federal Communications Commission regulations, you know).

OTHER METHODS FOR JAMMING

CB Radio

Get your old CB radio out—you remember, from the 1970s. Every idiot, including yours truly, had one. Next, you need to buy a linear amplifier. Again, they are illegal to use but not that difficult to locate. You can often find one at swap meets, flea markets, truck stops, or from radio freaks. A CB normally puts out about 5 watts, but a linear amplifier can boost this up to 400 watts. With this device in place on your CB, all you need to do is key the mic and it puts out enormous and excessive RF energy. It amplifies two-way radio signals far beyond normal output.

Another method of jamming can be accomplished with a Tesla Coil. This is fun to play with but is very dangerous. It can cause major problems with TV and radio reception. A word of caution: a Tesla Coil can destroy computers, erase tapes, and completely ruin all electrical equipment even if they are not plugged in. That's what these coils were invented to do, provide electricity without the need for wires. One man even told me how the coil erased the magnetic strips on the back of his credit cards. I mention Tesla Coils *for academic purposes only*.

Grid Dip Meter

Still another method of audio jamming may be accomplished with a grid dip meter. This piece of equipment is used to test resonant frequencies of circuits or antennas. It is actually a low-power, wide-band transmitter. A grid dip meter will overlay an audio tone over the reception of a TV or radio.

This method is one of my favorites. You can cause major irritation in your neighborhood by removing the suppress caps from the plug leads on your lawn mower, trimmer, hedge clipper, or

even your car. Or you can remove the suppressive component(s) from items like hair dryers, electric drills, or vacuum cleaners. Anyone in your neighborhood who has a TV or radio on will get

rotten reception until you decide to turn off your improvised jammer. Attaching a simple antenna, such as a wire coat hanger, will increase the range of these devices.

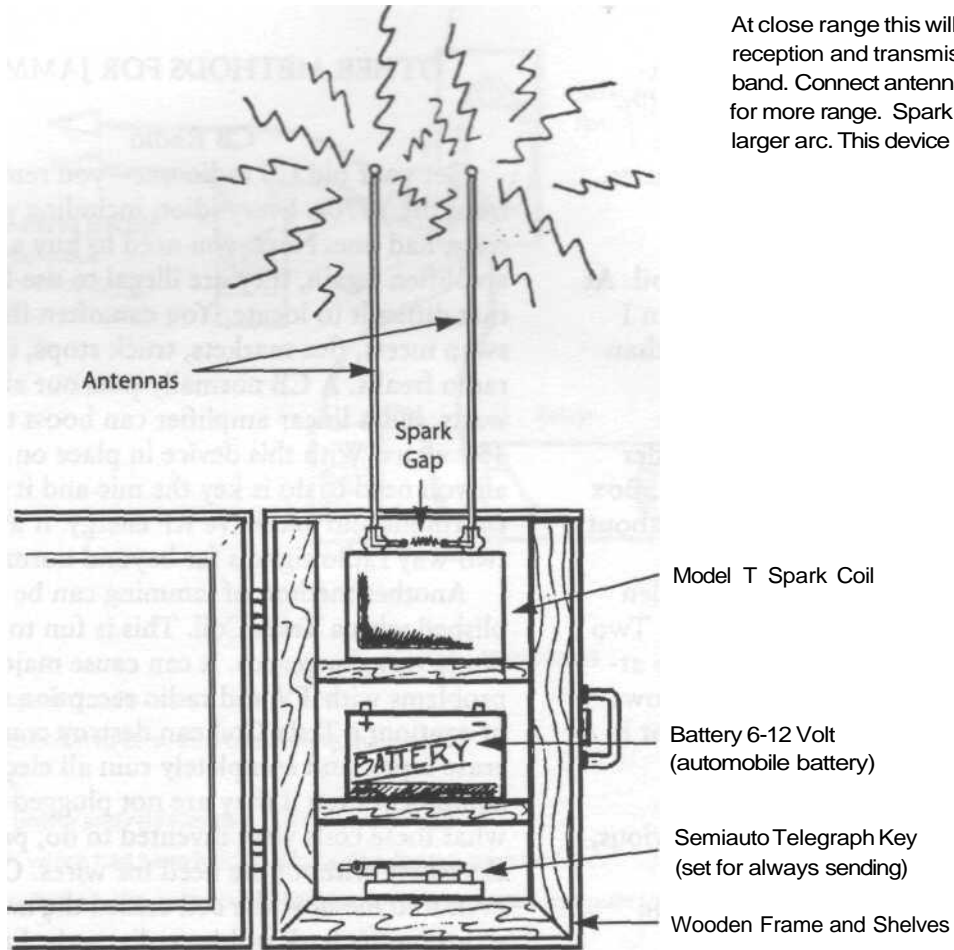

At close range this will interfere with all reception and transmission over a broad band. Connect antenna to a television tower for more range. Spark gap should be set at a larger arc. This device works through walls.

Entire unit is built into a briefcase or suitcase.

SCHEMATIC

On/Off Switches (telegraph key)

6-12 Volt DC, High-Capacity Battery

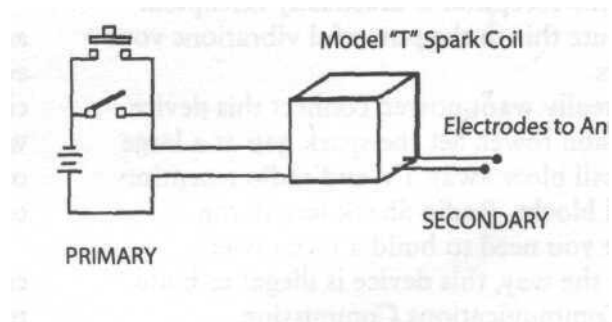

FOG MACHINE AND F/X EFFECT WITH FOG MACHINE AND MOVIE PROJECTOR

A fog machine has many theatrical uses, and although an industrial model costs a lot, an improvised one can be constructed easily with a few tools and a little time.

To build the fog machine, you need an old coffee urn, a wire mesh basket that will fit into the urn, a long piece of vacuum cleaner hose or tubing of that size, and some dry ice. Cut a hole in the side of the urn and attach the hose to it. Place about a gallon of water in the urn; it should be below the hose. Turn the urn on and let the water heat up. Place the dry ice into the basket

and drop it into the hot water. Place the lid over the urn. Instant fog will come out the end of the hose. To stop the fog, simply remove the basket of dry ice. This device will produce huge clouds of fog and is great for stage or outdoor use.

A movie projector can be used to create the illusion of someone materializing in the fog. A slide projector will work also.

Colored lights can be used to create colored fog. By projecting colored light from the base of the stage onto the white fog, you can make the fog any color you wish.

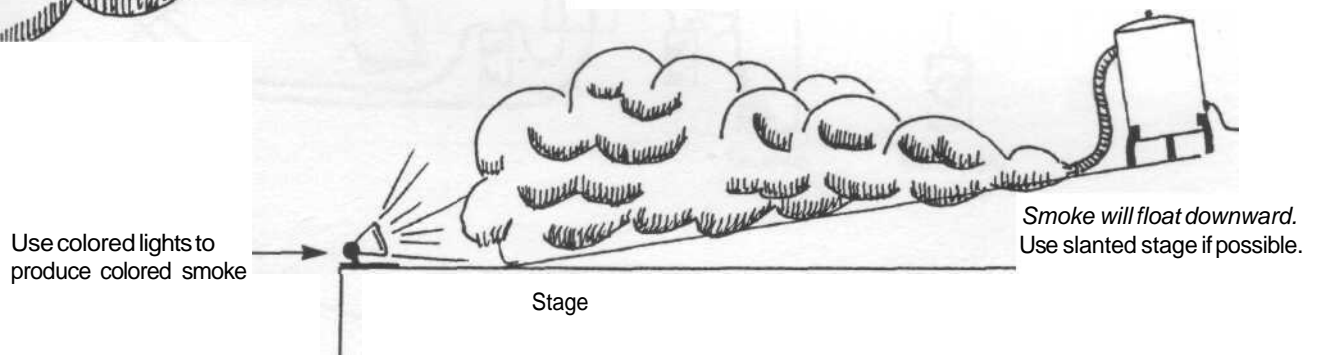
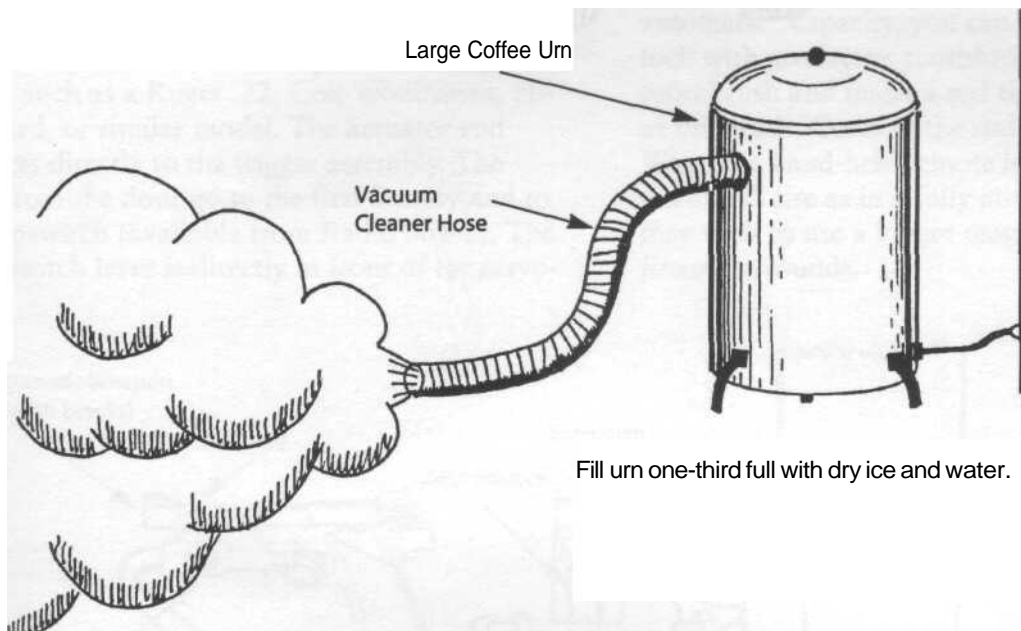

1. Lighting should be very dim.
2. Projector and fog machine should be hidden from view.

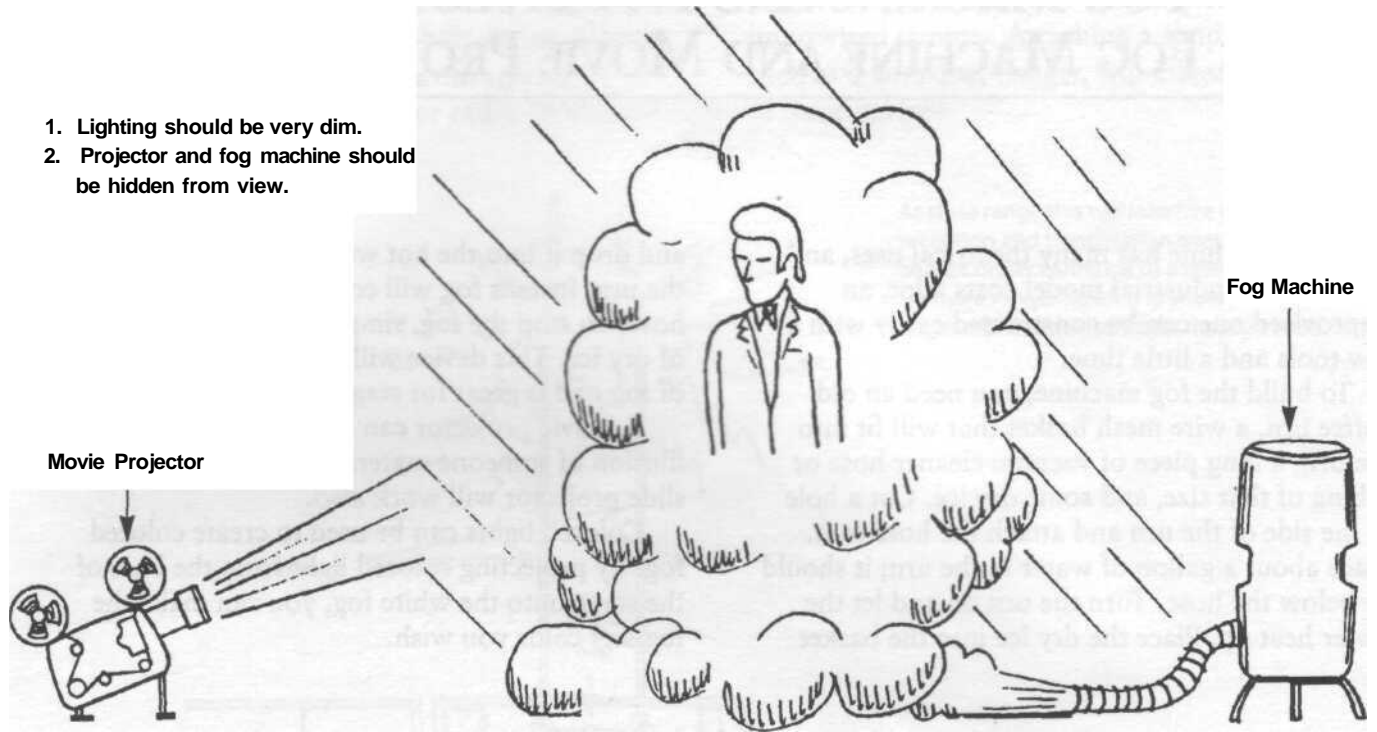

REMOTE-CONTROLLED WEAPON-FIRING SYSTEM

These next few devices were developed so the magician could, without being present, fire a handgun loaded with blanks.

The first system uses an electric door lock actuator and a standard remote-controlled, hand-held unit and servomechanism, much the same as a remote-controlled toy aircraft or car. You can buy the remote unit at almost any hobby shop. A 12-volt model #2504050 electronic door lock may be bought from Techne, 916 Commercial St., Palo Alto, CA 94303, or from similar stores that specialize in security systems.

The illustration shows how to construct the unit. Tape the door lock to the barrel of the semi-automatic pistol. It must be a pistol with a fixed barrel, such as a Ruger .22, Colt Woodsman, Hi-Standard, or similar model. The actuator rod connects directly to the trigger assembly. The leads from the door go to the first battery and to a microswitch (available from Radio Shack). The microswitch lever is directly in front of the servo-

arm. The leads from the servobox connect to the battery and the receiver. The hand-held unit controls it all. The entire unit and pistol fit into a wooden frame that keeps the pistol barrel in a horizontal position (wooden frame not shown in illustration). To fire the weapon, chamber a round and push the lever on the hand-held remote. The receiver gets the message, and the servo pushes against the microswitch, which, in turn, activates the electric door lock actuator and causes the rod to pull the trigger on the gun. This all happens within one or two seconds.

If you would like to fire the weapon in a "fully automatic" capacity, you can replace the door lock with an electric toothbrush. Remove the toothbrush and insert a rod that is the same size as the brush. Connect the rod to the gun trigger. When the hand-held remote lever is pushed, the pistol will fire as in a fully automatic mode. You may wish to use a longer magazine so you can fire more rounds.

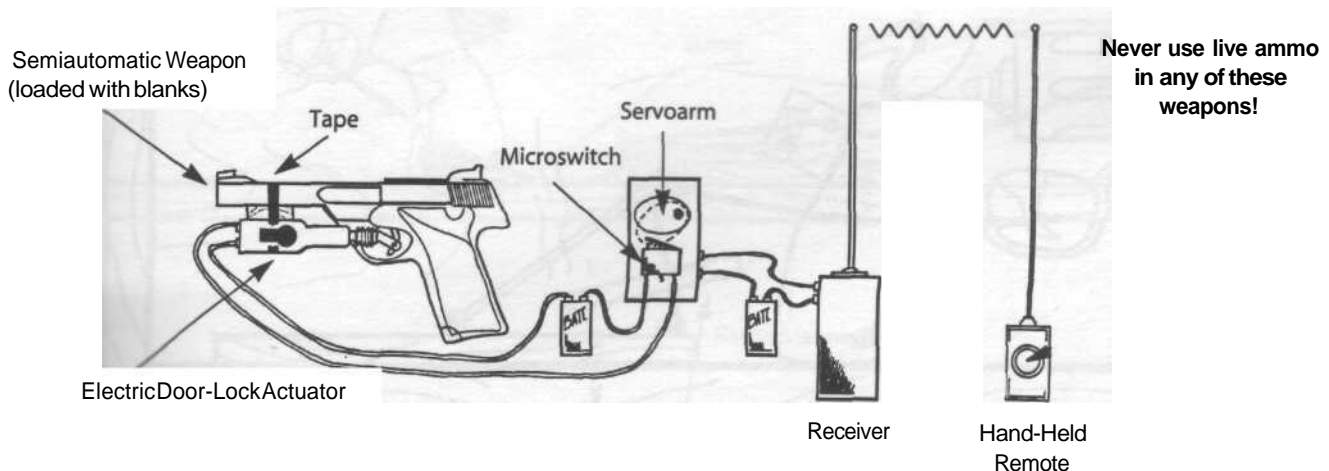

NOTE: -auto firing, replace the electric door lock actuator

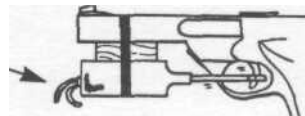

WARNING: Federal license may be required to construct this device. Never use live ammo in this weapon.

WARNING: THE EFFECTS AND DEVICES IN THIS BOOK ARE EXTREMELY DANGEROUS AND SHOULD BE UNDERTAKEN BY TRAINED PROFESSIONALS ONLY. THIS MATERIAL IS PRESENTED FOR INFORMATION PURPOSES ONLY.

RATTRAP CIGARETTE WEAPON-FIRING SYSTEM

This is a method of firing a weapon that provides a 5- to 7-minute delay. As in previous methods, the shooter need not be present after the cigarette is lit.

As shown in the accompanying illustration, the pistol is set into a wooden frame. The gun is held firmly in place by wooden blocks. Behind the gun is a rattrap screwed into the frame. Remove everything from the rattrap (not a mousetrap) except the fly bar (the part of the trap that flies over and kills the rat). Connect a piece of string from the fly bar to the base of

the rattrap nearest the gun. The fly bar should be under tension so that if the string were now severed the rattrap would snap. Next, connect another string from the fly bar to the trigger on the gun. Cock the gun. All that is left is to separate the strands on the first string and insert a lit cigarette. The cigarette burns down through the string, and this in turn releases the fly bar, which pulls the trigger on the gun.

A regular cigarette burning on its own takes about five minutes to burn down. A "100" burns about seven minutes.

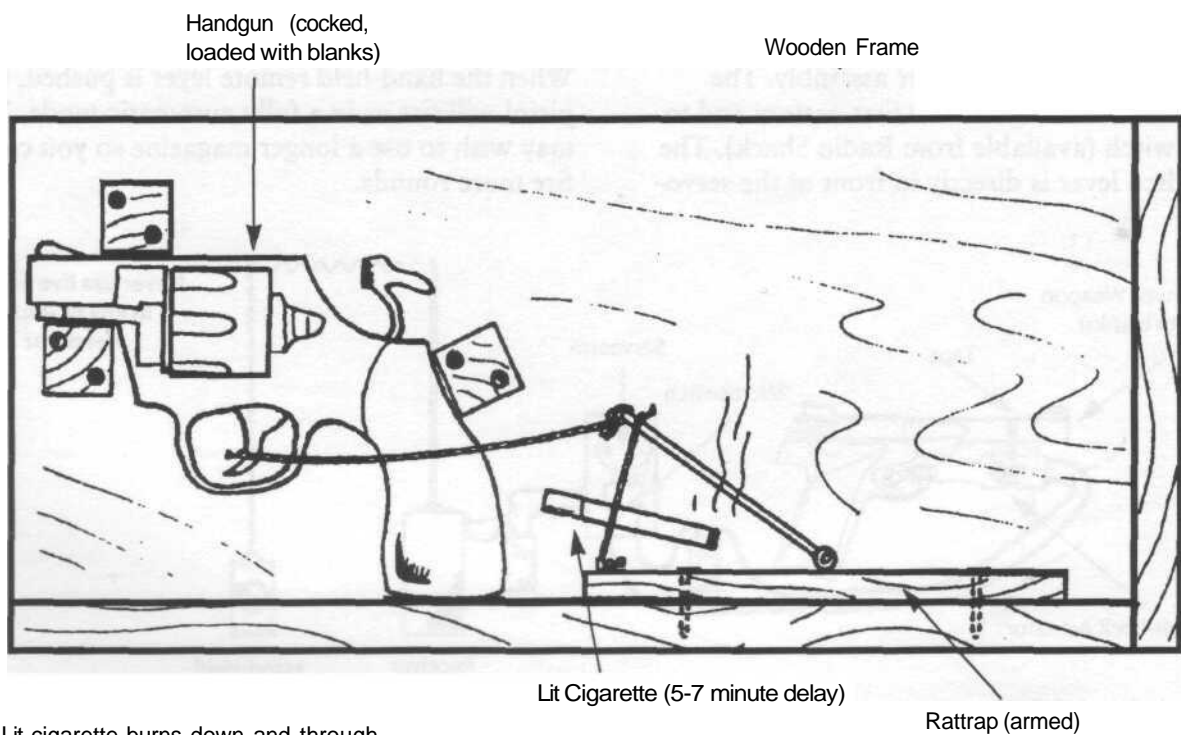

Lit cigarette burns down and through string. Fly bar pulls other string and, in turn, the trigger on the gun.

UP TO ONE-HOUR TIME-DELAY WEAPON-FIRING METHOD

This is another simple, straightforward way to fire a gun using a hands-off method.

The wooden frame in the illustration has the entire unit built into it. The gun is held in place in the cocked position with wooden blocks. From the trigger of the gun, a string runs to a rattrap (not a mousetrap) set for firing (killing the rat). The first string is attached to the fly bar of the trap, and a second string attaches the trap's trip lever to a kitchen timer set for the

desired length of time. Bolt the rattrap and the kitchen timer to the frame to keep them firm.

The device fires the gun when the string winds around the arm of the kitchen timer. This pulls the trip lever, which in turn pulls the spring-loaded fly bar on the rattrap and thus the trigger.

As with all these types of devices, this weapon is very dangerous in the wrong hands. Be careful to whom you show this.

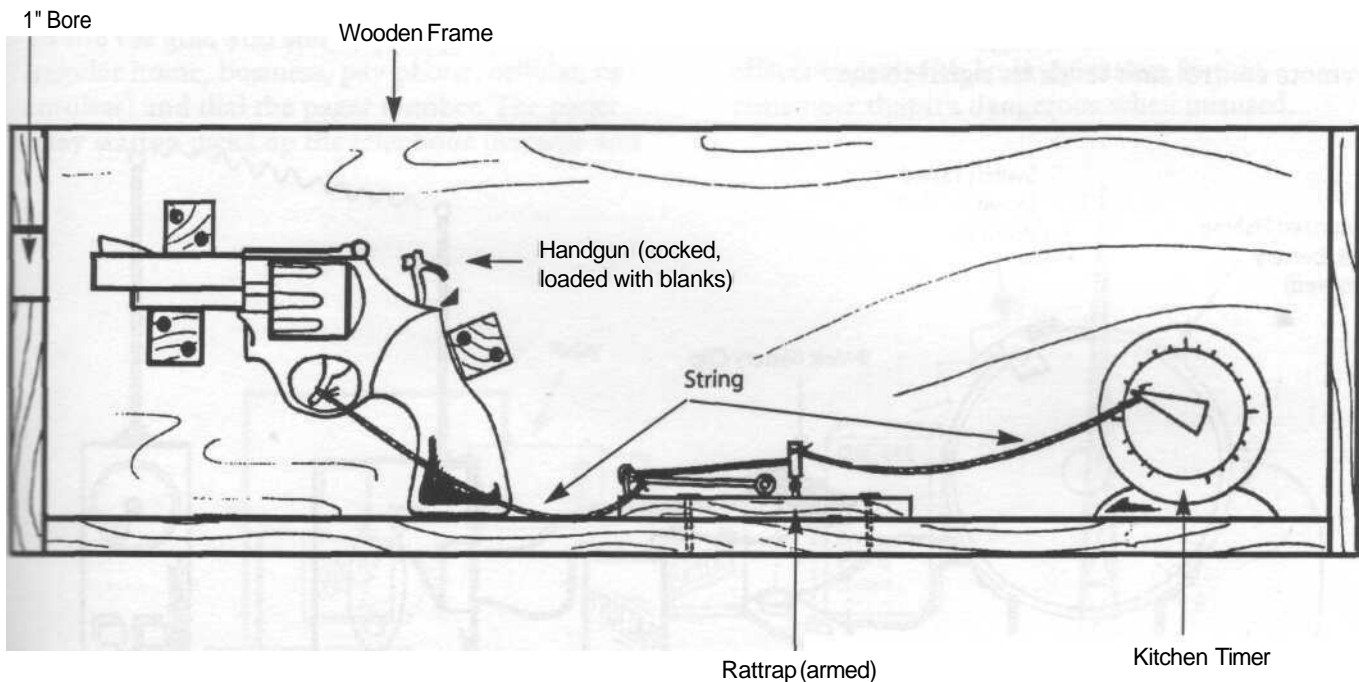

F/X REMOTE-CONTROLLED PULL/REEL

A pull has many applications in special effects work. I will describe how this device is constructed and give a couple of examples of how to use it.

You need to go to a hunting and fishing store (or K-Mart will do) and buy a good electric fishing reel. You will also need a remote-control unit, which consists of a servobox and a hand-held remote-control device (hobby shop). You will also need a small microswitch (Radio Shack), some wire, and a pine board on which to build it. Brackets may be bought or made from scrap metal.

Look at the illustration and you will see the device ready to use. Basically, the hand-held remote control unit sends its signal to the

servobox, and the servomechanism moves and pushes the microswitch arm, which completes the circuit. Remove the battery from the fishing reel and connect it directly to the servobox. The fishing reel has its "reel in" button depressed and taped in place. Once the circuit is complete, the extended fishing line is reeled in.

How could this device be used in special effects work? You could use it to pull something across a stage. With thinner line, you could suspend the device above the stage and use it to levitate something light. Use your imagination, friends; after all, I wrote this book for creative people.

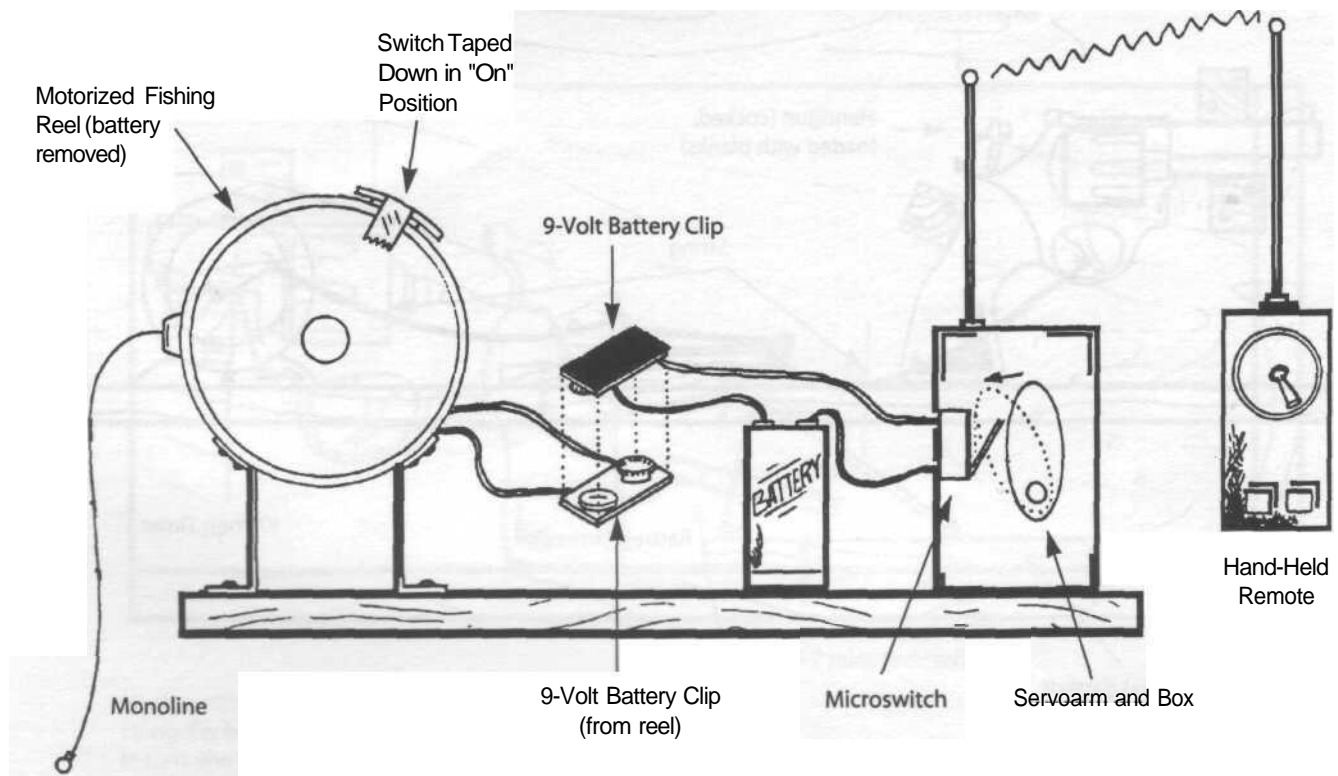

TELEPHONE REMOTE-CONTROLLED WEAPON-FUZING SYSTEM

This is quite possibly the most dangerous device in the book. In the wrong hands, it is deadly. I am including it here *for informational purposes only*.

This device lets you fire any gun from any telephone in the world. It's not at all complicated to construct, and all of the components, except for the electric door-lock actuator, may be bought at Radio Shack. (For the address to order this device, see remote-controlled weapon-firing system on page 31.)

Consult the illustration below as you read the following description of how the system works. To fire the gun, you simply pick up a telephone (regular home, business, pay phone, cellular, or cordless) and dial the pager number. The pager relay station picks up the telephone message and

in turn sends out the signal that trips the pager/beeper. The pager has two leads soldered directly to the piezo buzzer in it (you can remove the buzzer if you wish). These leads are wired directly to the two leads connected to that buzzer. (Take the back off the beeper to see this.) From the pager/beeper the wire leads connect to a small relay. On the other side of the relay are the leads connected to the electric door-lock actuator and a second battery. The electric door-lock actuator in turn pulls the trigger on the gun. (Refer back to page 31 if you do not understand how this door lock is connected to a handgun.)

This device has great potential for the special effects expert with an imagination, but do remember that it's dangerous when misused.

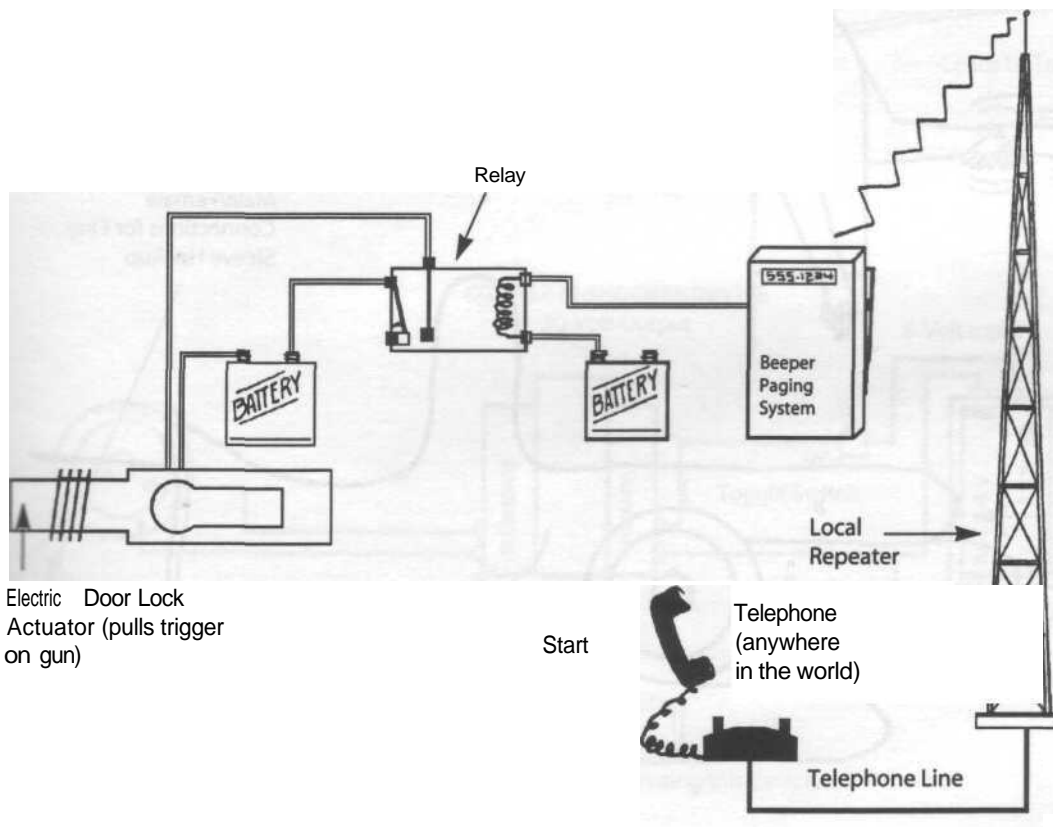

WARNING: THE EFFECTS AND DEVICES IN THIS BOOK ARE EXTREMELY DANGEROUS AND SHOULD BE UNDERTAKEN BY TRAINED PROFESSIONALS ONLY. THIS MATERIAL IS PRESENTED FOR INFORMATION PURPOSES ONLY.

SHOCKER

The shocker is for all you practical jokers out there. It is a nonlethal way to provide a small shock of electricity to anyone who is foolish enough to shake hands with you.

The accompanying illustrations show how to construct the device. You need to buy a small step-up transformer from a hobby shop. Hook up the battery pack and hand unit to the transformer as shown. Connect the hand unit to a leather glove. The most important thing to remember is to not throw the toggle switch until you have the spectator's hand in yours. If you activate the

switch and then shake hands, the device will not work. I won't bore you with why; it's the way transformers work. Follow the instructions to the letter. I don't want you to kill anyone.

Don't use this device on young children or elderly people. Kids will cry, and some elderly person may have a pacemaker that will respond adversely to your form of humor.

I prefer to shake hands with some big beef-eating oaf who wants to show the world how all my tricks work. Shake hands to show no hard feelings, then ZAP him.

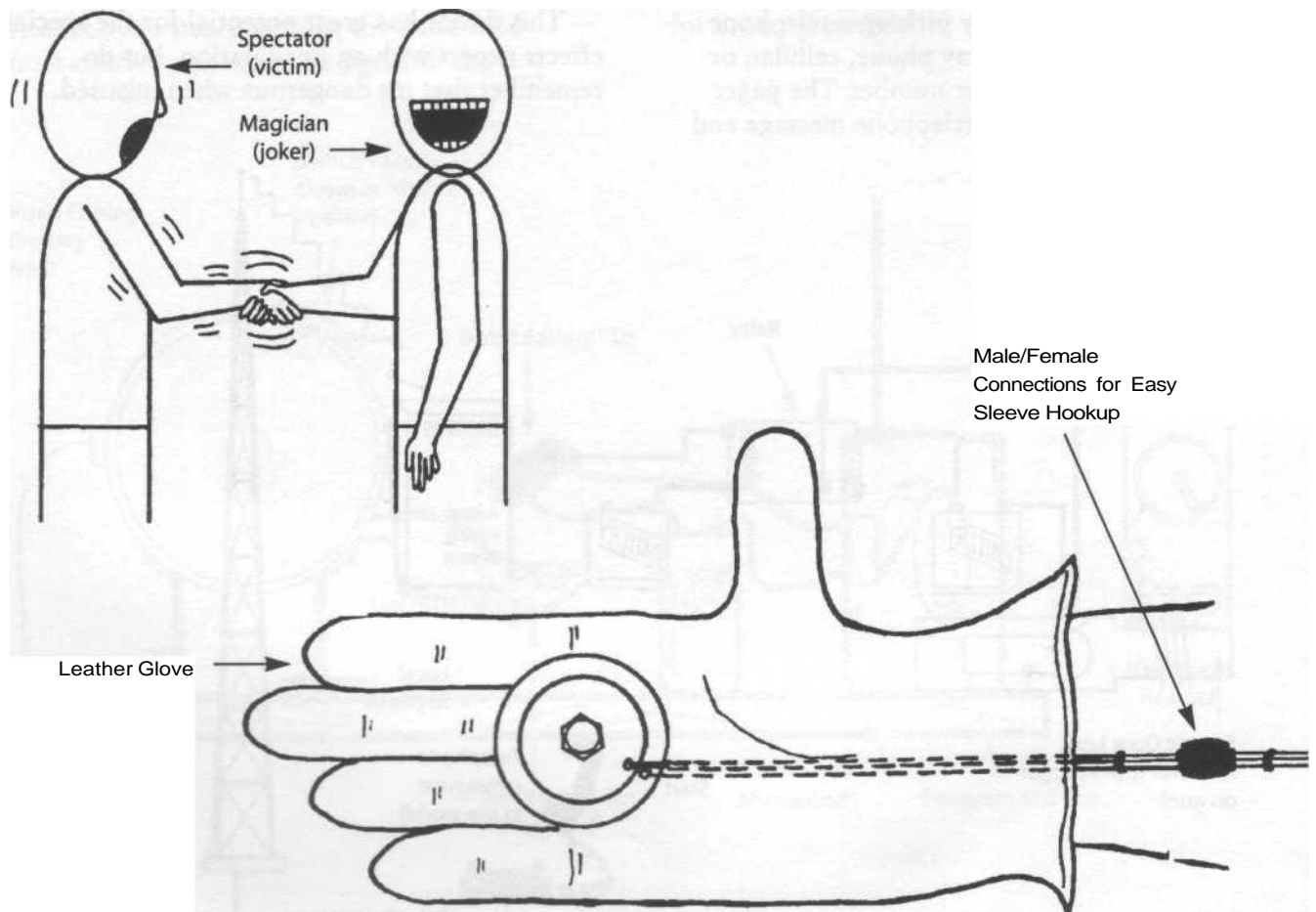

EXPLODED ILLUSTRATION (OF HAND UNIT)

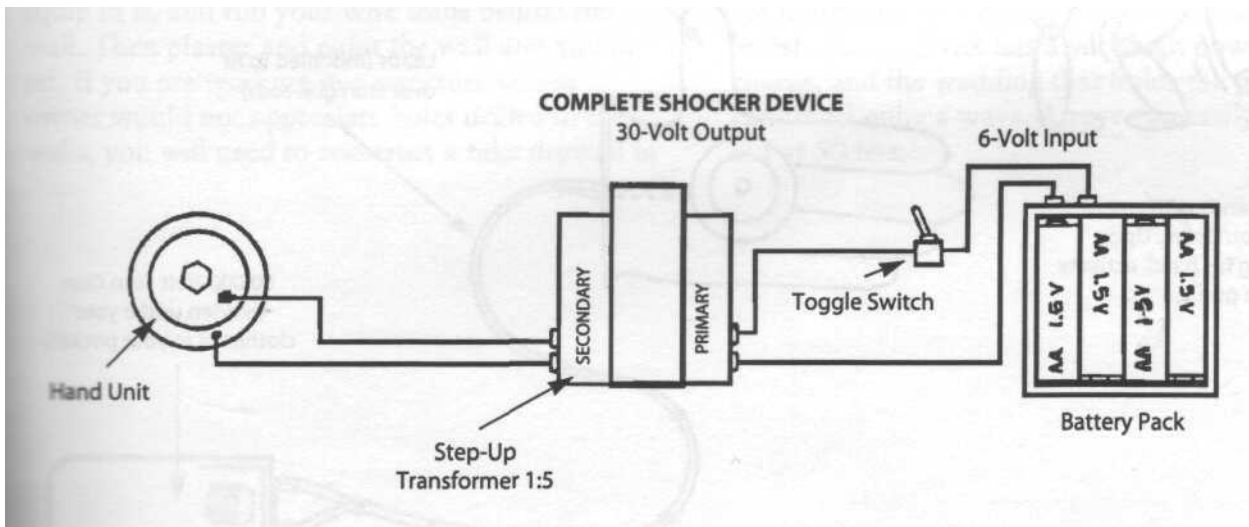
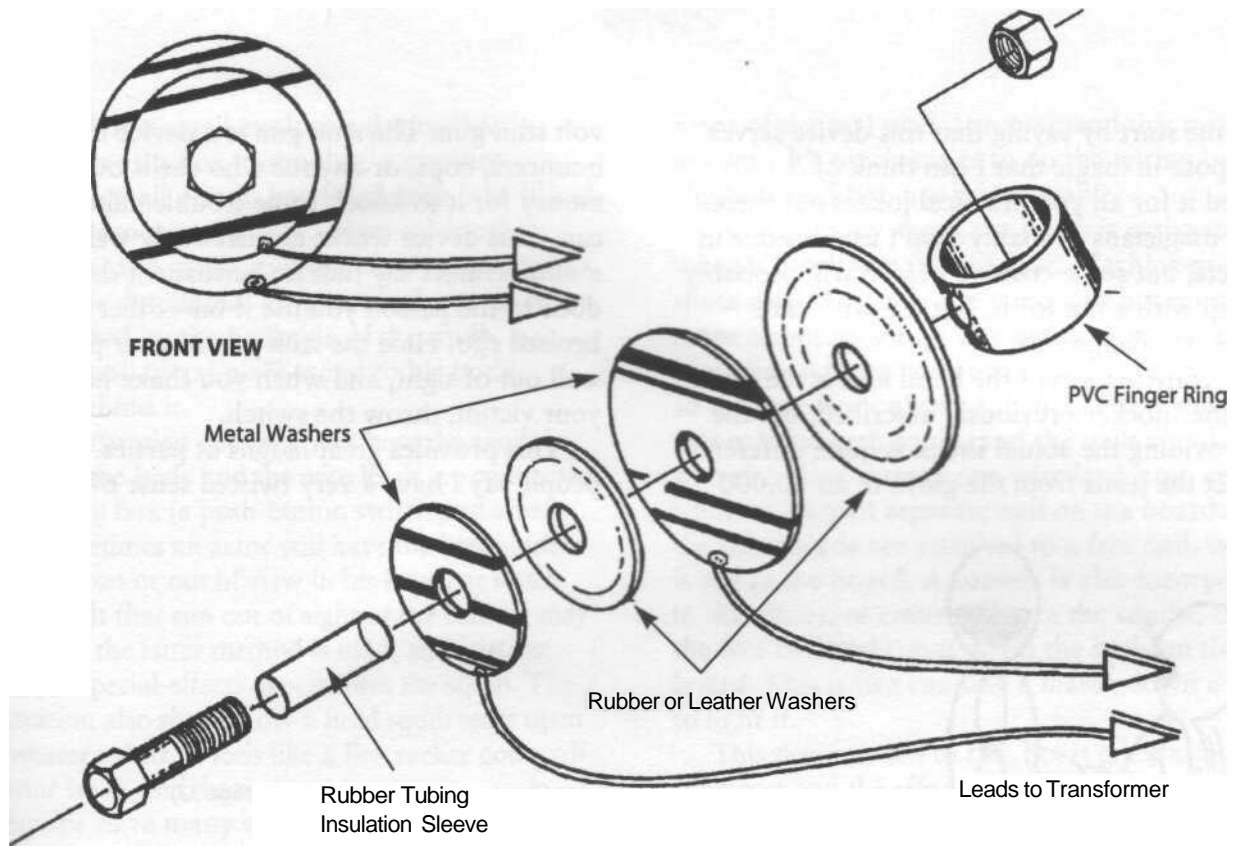

NOTE: Wear gloves when using this device.

WARNING: THE EFFECTS AND DEVICES IN THIS BOOK ARE EXTREMELY DANGEROUS AND SHOULD BE UNDERTAKEN BY TRAINED PROFESSIONALS ONLY. THIS MATERIAL IS PRESENTED FOR INFORMATION PURPOSES ONLY.

SHOCKER DELUXE

Let me start by saying that this device serves no purpose in magic that I can think of. I included it for all you practical jokers out there. Fellow magicians probably won't use this one in their acts, but some creative person will probably come up with a use for it. But use with care because it is dangerous.

The construction of the hand unit is the same as for the shocker previously described, but the unit providing the actual shock is quite different. Connect the leads from the glove to an 80,000-

volt stun gun. The stun gun is a device used by bouncers, cops, or anyone who shells out the money for it to knock some troublemaker on his can. This device works devastatingly well. Its manufacturers say that no permanent damage is done to the person you use it on—other than a bruised ego. Hide the stun gun in your pocket well out of sight, and when you shake hands with your victim, throw the switch.

This provides great laughs at parties. Some people say I have a very twisted sense of humor.

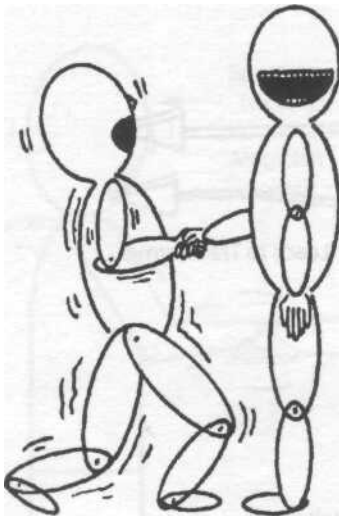

Shake hands with spectator/victim. Upon grasping his hand, activate the stun gun.

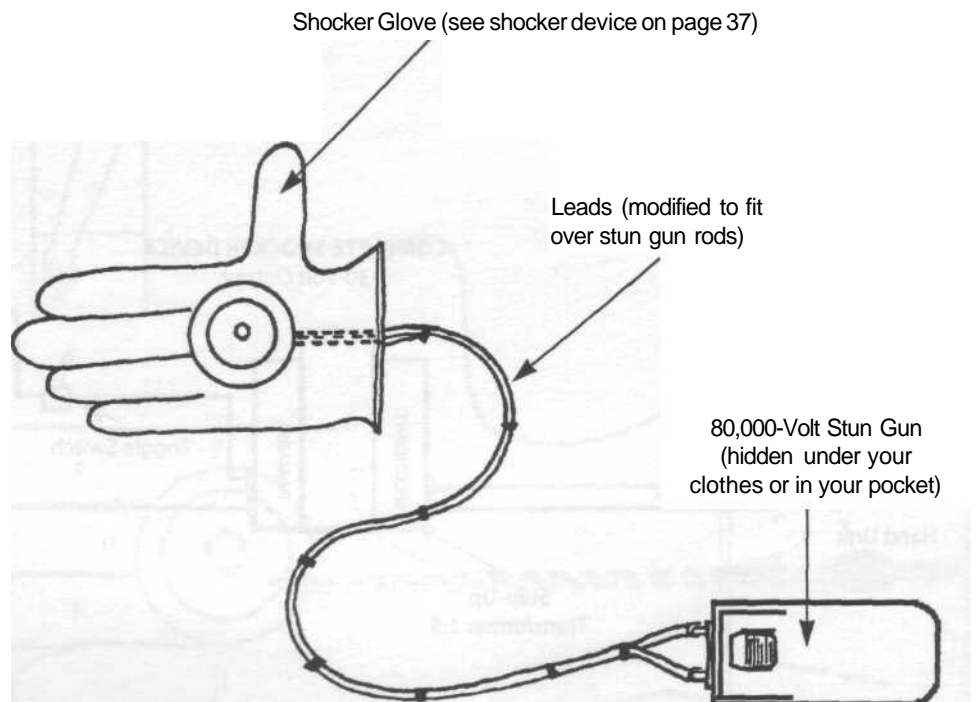

SQUIB WORK

A squib is a small explosive device that is attached to an actor to simulate a gunshot wound. A small plastic bag filled with fake blood (usually Karo syrup and red food coloring) is placed over the squib, and the bag ruptures when the squib is detonated. To prevent the actor from being injured by the backside of the squib, he wears a small metal plate taped to his body directly behind it.

The illustration demonstrates how the squib is placed on the body and the wire leads are connected to the firing box (a push-button switch and a battery). Sometimes an actor will have the box hidden on his person or out of view in his hand, or much longer leads that run out of sight of the camera may be used. If the latter method is used, an assistant, usually a special-effects expert, fires the squib. The illustration also shows how a fired squib tears open the wearer's shirt. It feels like a firecracker going off on your body, and, basically, it is.

Squibs have many other uses in the entertainment industry. You could simulate a gunshot hole in a wall. First you drill a hole in the wall, set the squib in it, and run your wire leads behind the wall. Then plaster and paint the wall and you're set. If you are working in a structure whose owner would not appreciate holes drilled in the walls, you will need to construct a fake drywall in

front of the real wall. I recommend this method anyway. It's much easier to do the wiring behind the fake wall because it is movable.

As with body shots, the squib is activated when a blank gun is fired at it. Machine-gun shots work basically the same way but require a more elaborate setup. The best method involves pounding a series of nails vertically into a board so they protrude about 2 inches. There should be one nail for each squib, and the nails should be in a straight line. Attach one wire lead from each squib to its own separate nail on the board. All the other leads are attached to a free nail, which is not in the board. A battery is also incorporated in this series, of course. To fire the squibs, take the free nail and run it down the nails on the board. This is like running a match down a wall to light it.

This device is fun to fire, but it takes hours to construct and the effect is over in about 3 seconds.

CAUTION: Do not fire a blank gun directly at a human! Blanks are very dangerous. A 9mm blank fired point-blank at a person's head can be lethal. Also, a blank has a very high powder charge, and the wadding that holds the powder in can travel quite a ways. An eye can easily be put out at 50 feet.

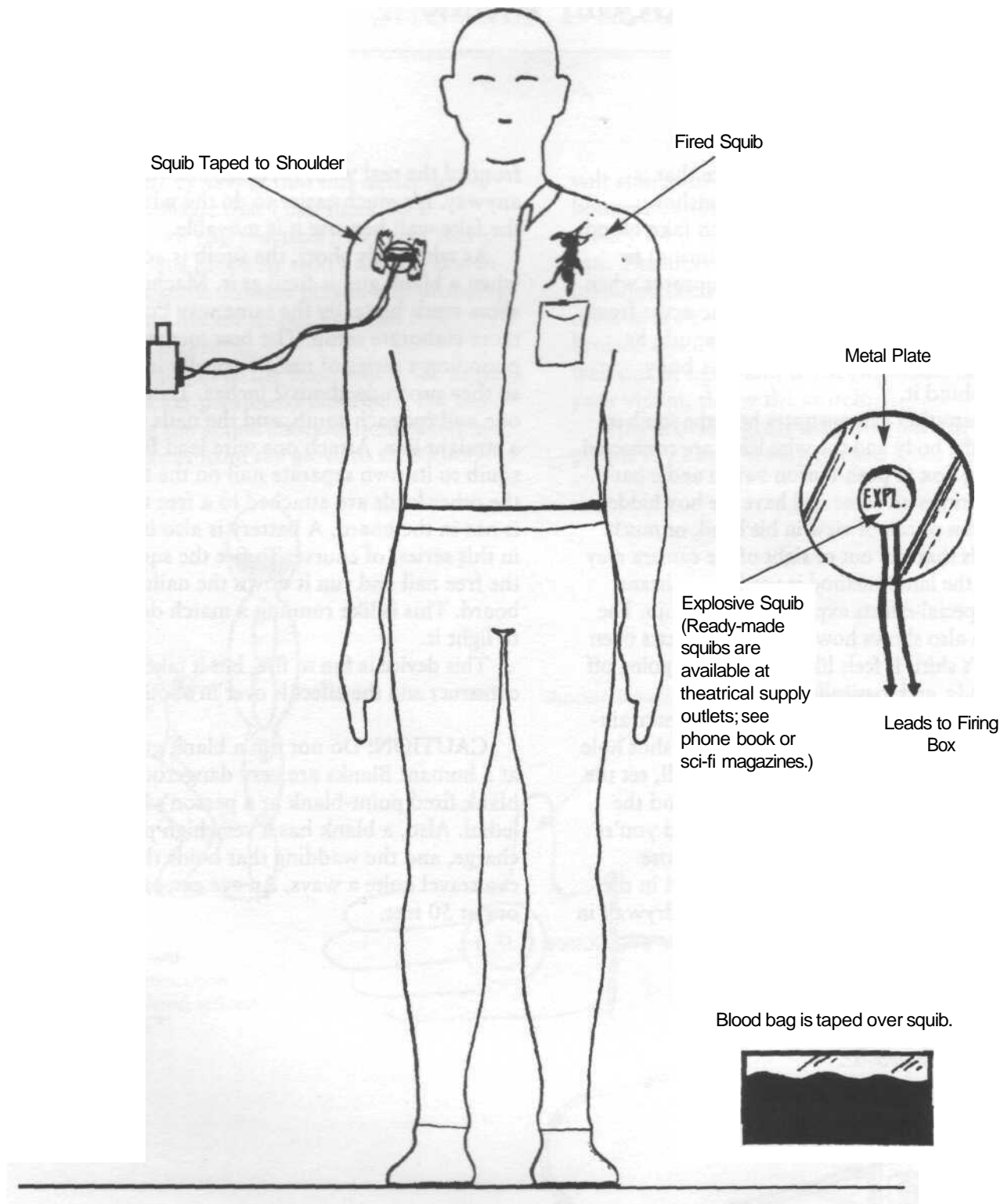

Back of Wall
Electronically Fired Squibs in Place and Ready to Be Fired

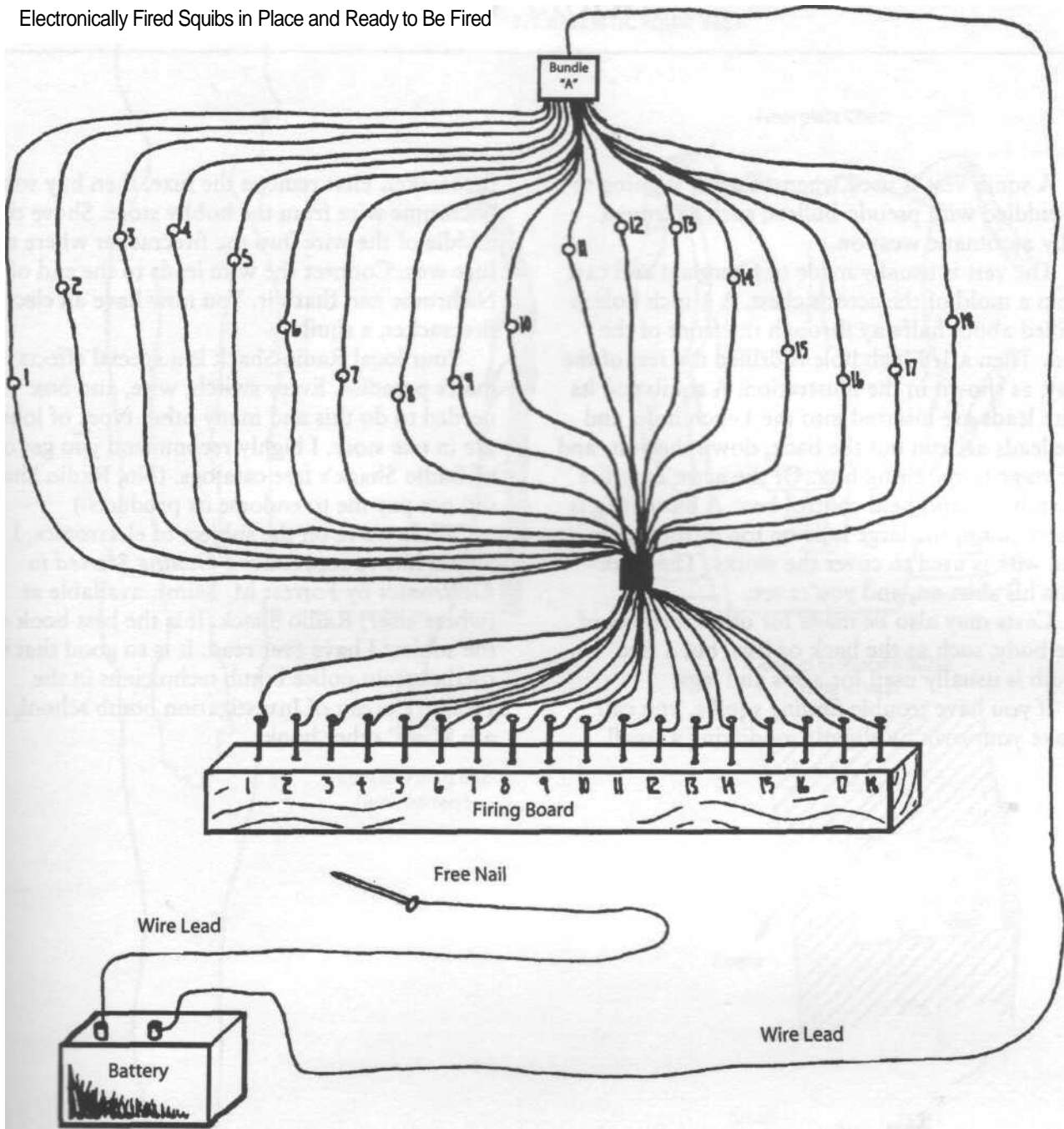

Each squib has two wire leads protruding from it. One lead from each squib goes to one of the nails in the board. The other leads (the free ones) are all bunched together (bundle A). A single lead, which is attached to all the leads in that bundle, comes out and runs to one of the battery terminals. A wire lead runs from the opposite battery terminal to a free nail. By touching the free nail to a nail on the board, a squib is fired.

SQUIB VEST

A squib vest is used when an actor is going to be riddled with pseudo bullets, such as from a fully automatic weapon.

The vest is usually made of fiberglass and cast from a mold of the actor's chest. A 1-inch hole is drilled about halfway through the front of the vest. Then a 1/8-inch hole is drilled the rest of the way, as shown in the illustration. A squib and its wire leads are inserted into the 1-inch hole, and the leads are run out the back, down the vest, and off stage to the firing box. Or the actor may fire them by a hand-held control box. A blood bag is inserted into the large hole on top of the squib, and wax is used to cover the works. The actor puts his shirt on, and you're set.

Casts may also be made for other sections of the body, such as the back or legs, but a free squib is usually used for arms and legs.

If you have trouble finding squibs, you can make your own by slightly modifying a small

firecracker. First remove the fuze, then buy some Nichrome wire from the hobby store. Shove the middle of the wire into the firecracker where the fuze was. Connect the wire leads to the end of the Nichrome and that's it. You now have an electric firecracker, a squib.

Your local Radio Shack is a special effects man's paradise. Every switch, wire, and box needed to do this and many other types of jobs are in one store. I highly recommend you get one of Radio Shack's free catalogs. (No, Radio Shack did not pay me to endorse its products.)

While we're on the subject of electronics, I would like to recommend *Getting Started in Electronics* by Forrest M. Mims, available at (where else?) Radio Shack. It is the best book on the subject I have ever read. It is so good that it is used to train police bomb technicians in the Federal Bureau of Investigation bomb school, as are Mims' other books.

FX BALLISTIC SQUIB VEST

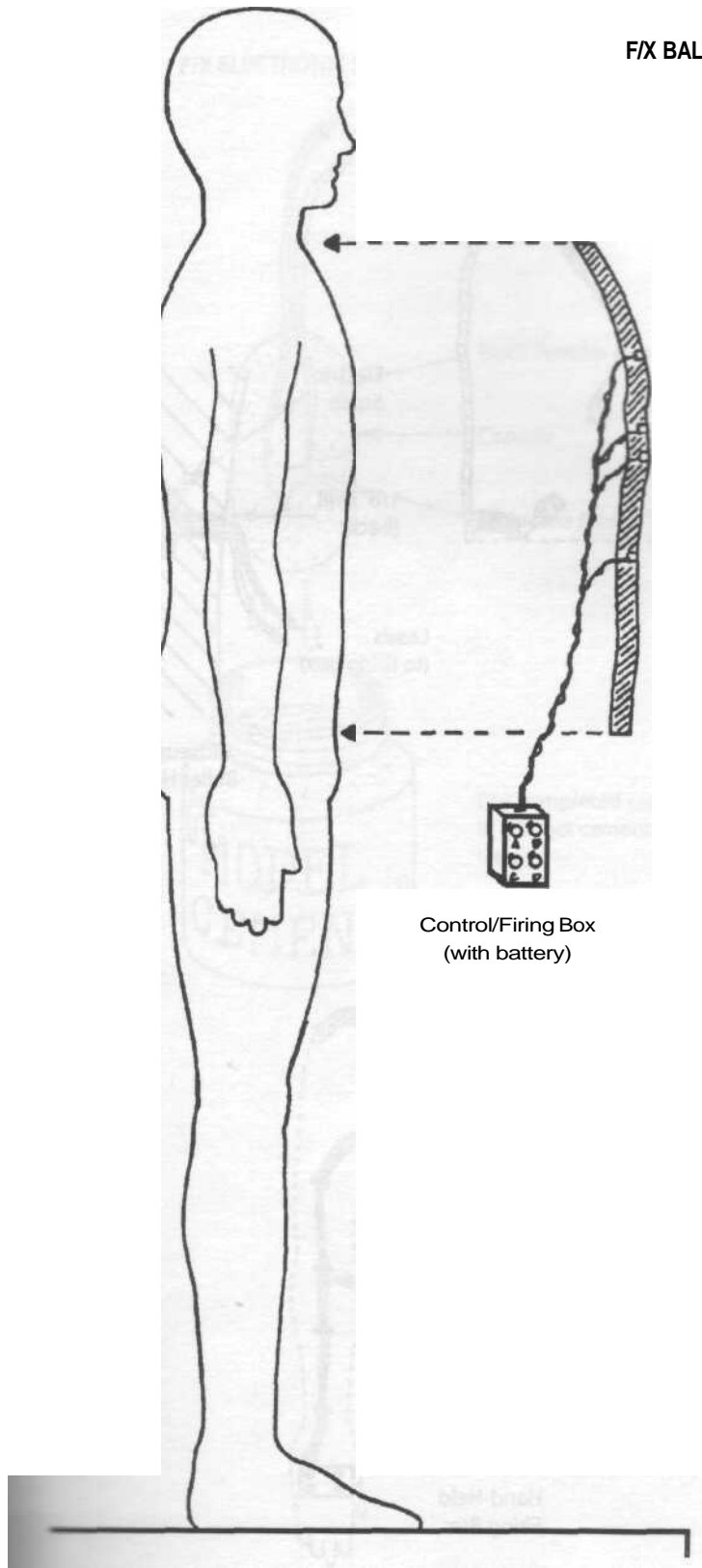

Fiberglass Chest

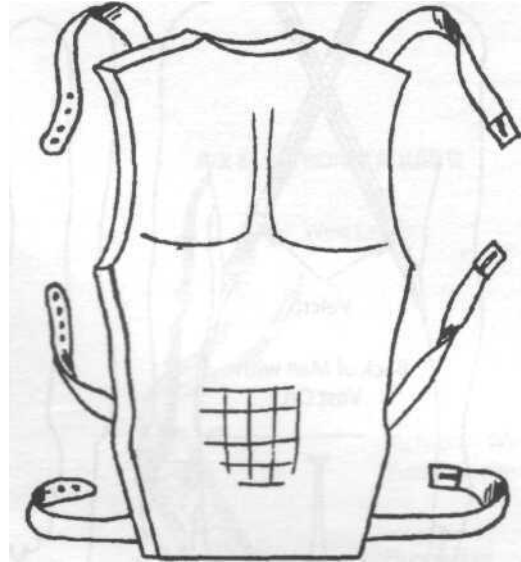

Closeup of Pseudo Bullet Hole in Vest

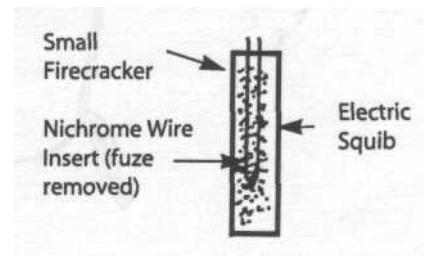
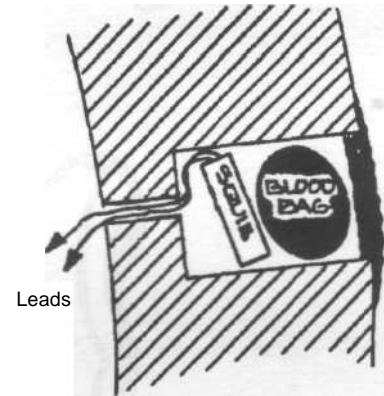

WARNING: THE EFFECTS AND DEVICES IN THIS BOOK ARE EXTREMELY DANGEROUS AND SHOULD BE UNDERTAKEN BY TRAINED PROFESSIONALS ONLY. THIS MATERIAL IS PRESENTED FOR INFORMATION PURPOSES ONLY.

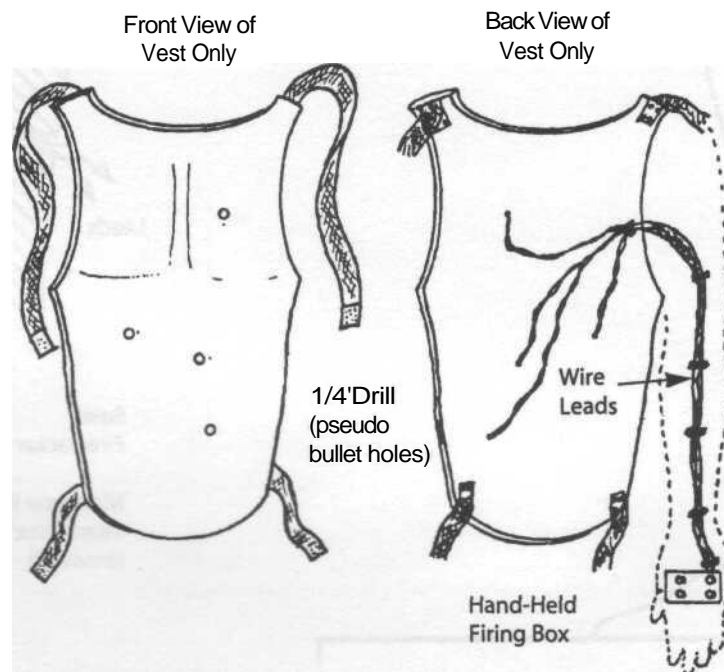
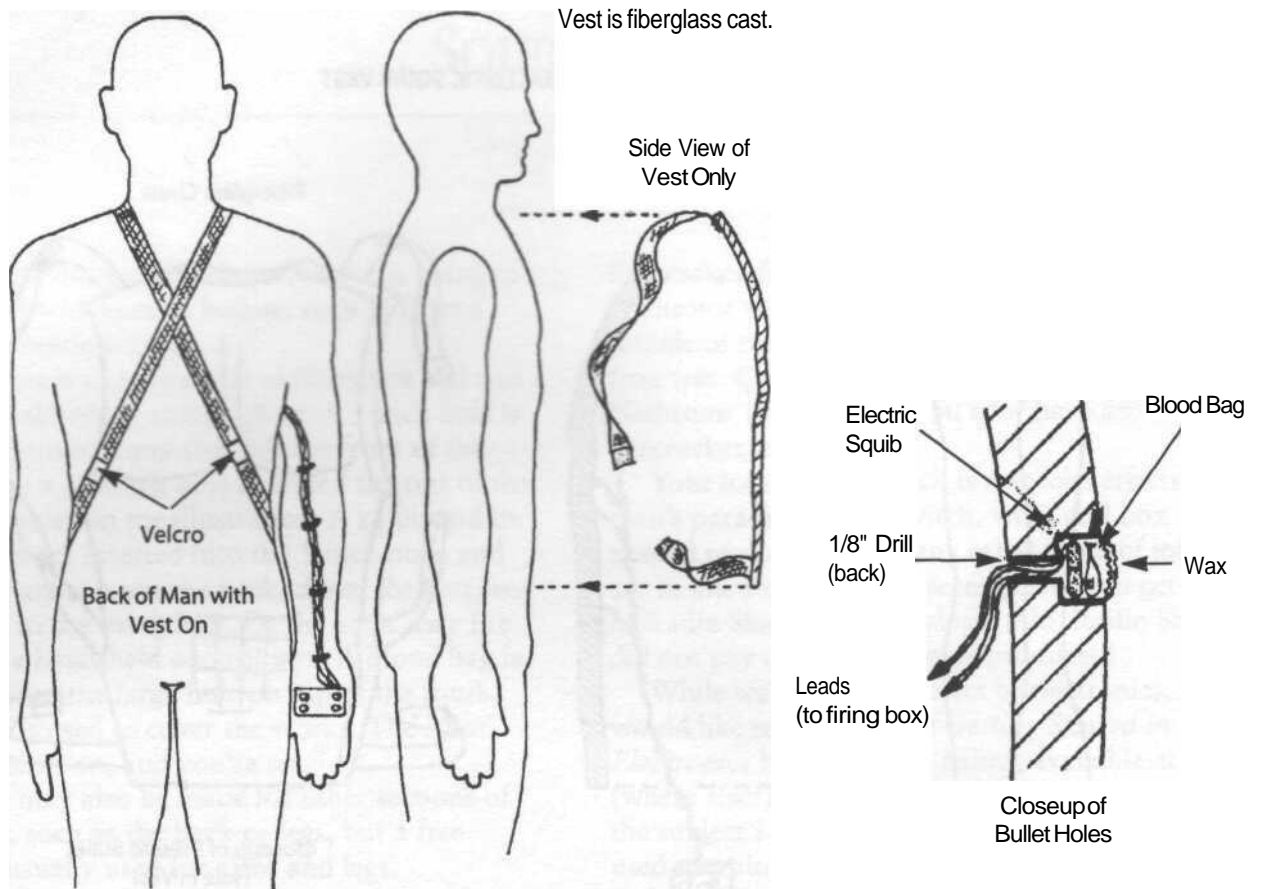

F/X ELECTRONIC SQUIB I

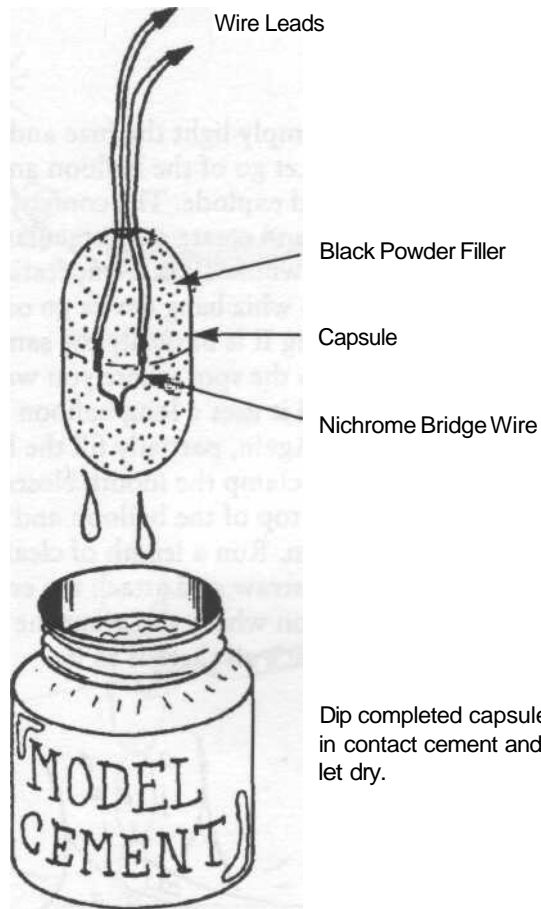

Dip completed capsule in contact cement and let dry.

F/X ELECTRONIC SQUIB II

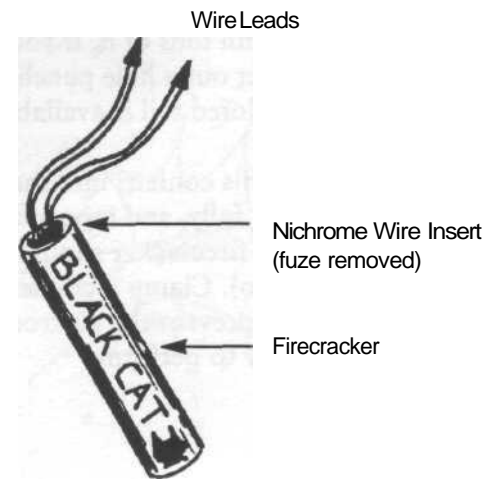

Where to Find:

- Empty Capsules—Health Food Stores
- Nichrome Wire—Hobby Shop (model rocket ignitors)
- Black Powder—Gun Reloading Supply
- Wire Leads—Electronic Supply (Radio Shack)
- Model Cement—Hobby Shop or Drugstore

WARNING: THE EFFECTS AND DEVICES IN THIS BOOK ARE EXTREMELY DANGEROUS AND SHOULD BE UNDERTAKEN BY TRAINED PROFESSIONALS ONLY. THIS MATERIAL IS PRESENTED FOR INFORMATION PURPOSES ONLY.

WHIZ BANG I & II

These two little toys are great fun to play with and easy to make. Kids love them, so I hope you will use them in your act.

Whiz Bang I is a large, fully inflated balloon that is partially filled with colored confetti, either paper or metallic. I prefer metallic. Party suppliers can provide you with tons of it. If you want to make your own, get out a hole punch and some aluminum foil. Colored foil is available around Christmastime.

Stuff some of this confetti into the balloon, inflate the balloon fully, and tape a firecracker to one side of it. The firecracker should have a long fuze (5 inches or so). Clamp a clothespin over the balloon mouth to prevent the air from escaping until you are ready to perform.

To use, simply light the fuze and remove the clothespin. Let go of the balloon and it will fly up in the air and explode. The confetti will fly everywhere and create a spectacular sight. I watched the whole 1992 Democratic Convention just to see its whiz bang device go off.

Whiz Bang II is basically the same thing except it's guided to the spot where you want it to explode, and it uses a long balloon instead of a round one. Again, partially fill the balloon with confetti and clamp the mouth closed. Tape a straw to the top of the balloon and a firecracker to the bottom. Run a length of clear fishing line through the straw and attach the ends of the line to the location where you want the balloon to explode. That's all there is to it.

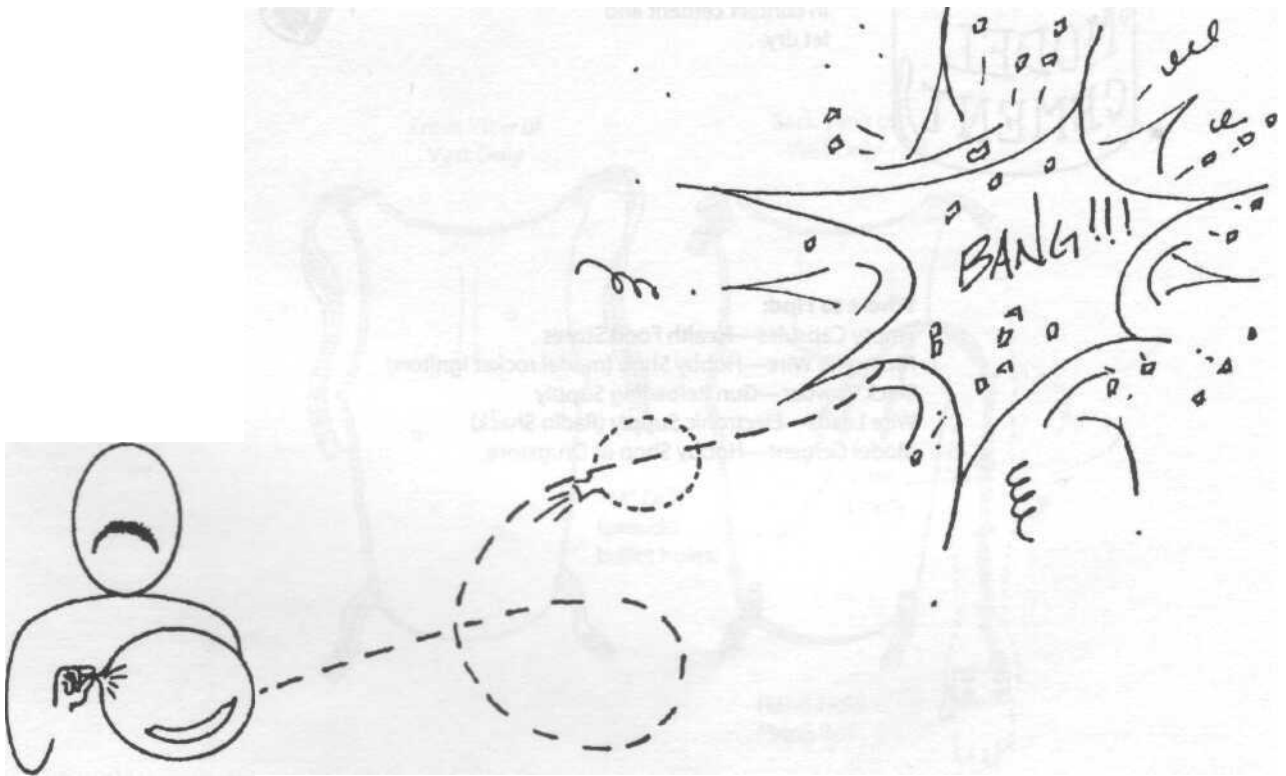

WHIZ BANG I

Do not tie mouth of balloon. Keep the balloon mouth pinched until you're ready.

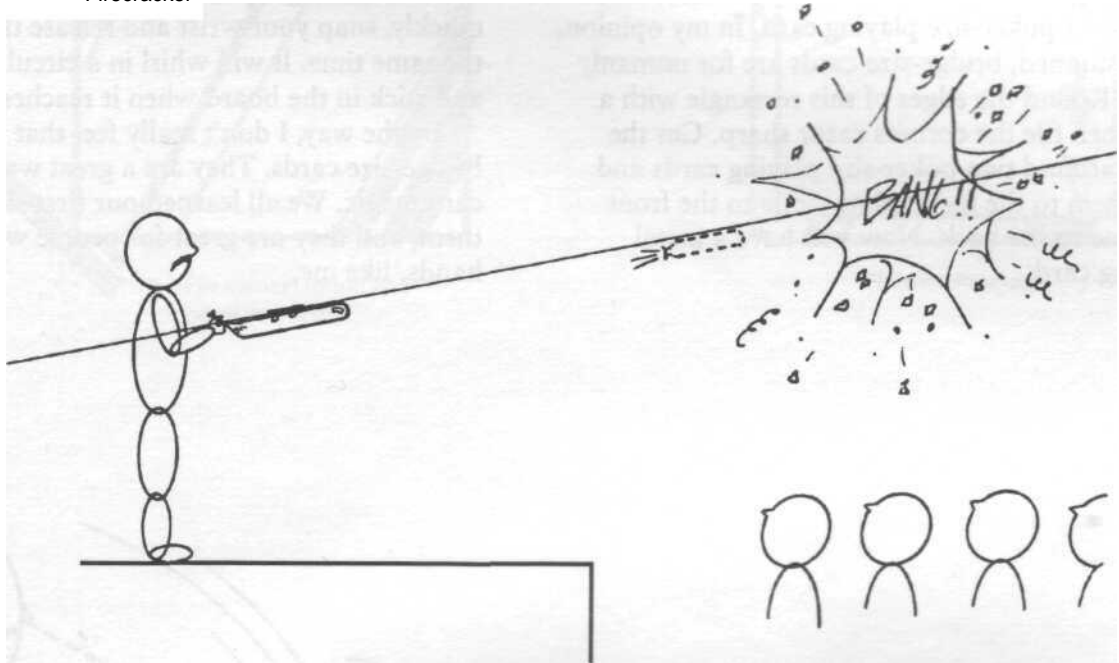
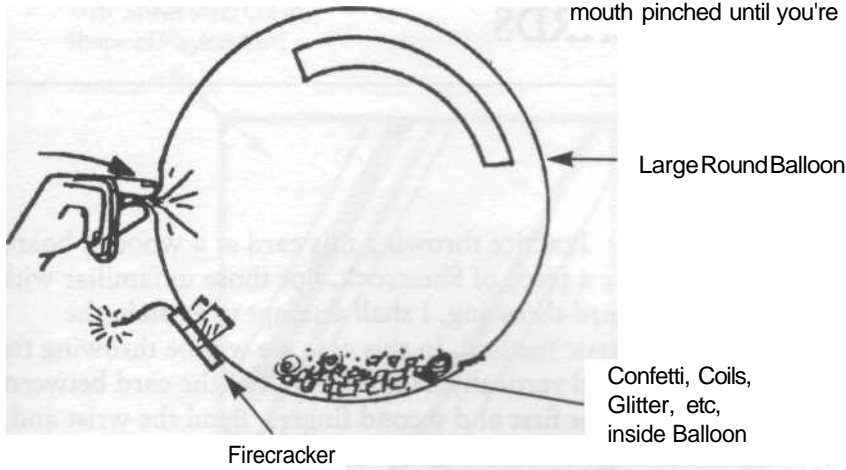

WHIZ BANG II

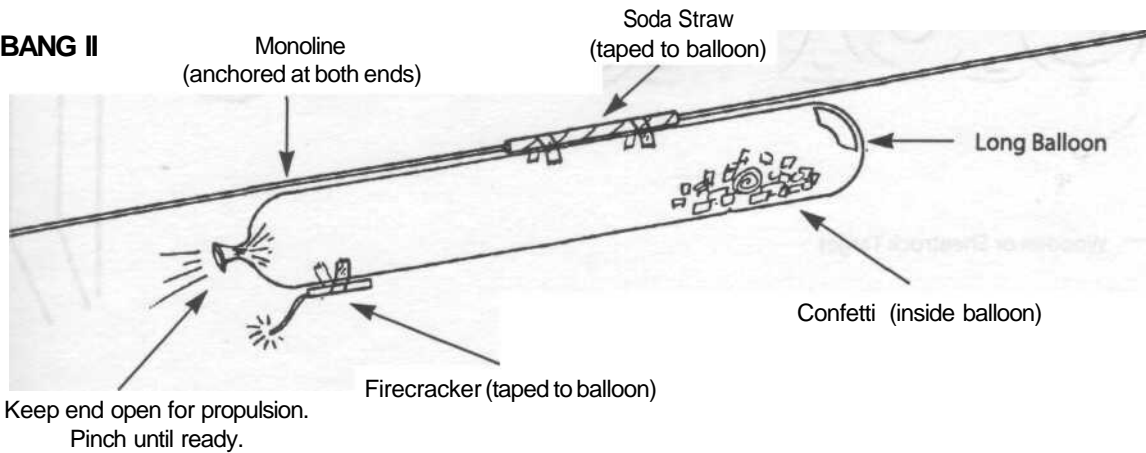

WARNING: THE EFFECTS AND DEVICES IN THIS BOOK ARE EXTREMELY DANGEROUS AND SHOULD BE UNDERTAKEN BY TRAINED PROFESSIONALS ONLY. THIS MATERIAL IS PRESENTED FOR INFORMATION PURPOSES ONLY.

DEATH CARDS

Death cards. I knew that title would make you look twice. Well, what else could I call them, anyway? Their use is strictly for flash on stage or at a party.

Buy some 1/16-inch sheet steel at the hardware store (which, with some imagination, is another great magic store). Cut the steel into the shape of a poker-size playing card. In my opinion, old-fashioned, bridge-size cards are for unmanly types. Round the edges of this rectangle with a file. Then file the corners razor sharp. Cut the edges around two poker-size playing cards and glue them to the metal plate—one to the front and one to the back. Now you have a metal playing card.

Practice throwing this card at a wooden board or a piece of Sheetrock. For those unfamiliar with card-throwing, I shall attempt to explain the basic method. In this case we will be throwing the card vertically. Hold one end of the card between your first and second fingers. Bend the wrist and elbow back slightly toward your shoulder. Very quickly, snap your wrist and release the card at the same time. It will whirl in a circular motion and stick in the board when it reaches it.

By the way, I don't really feel that way about bridge-size cards. They are a great way to learn card magic. We all learned our first sleights with them, and they are great for people with small hands, like me.

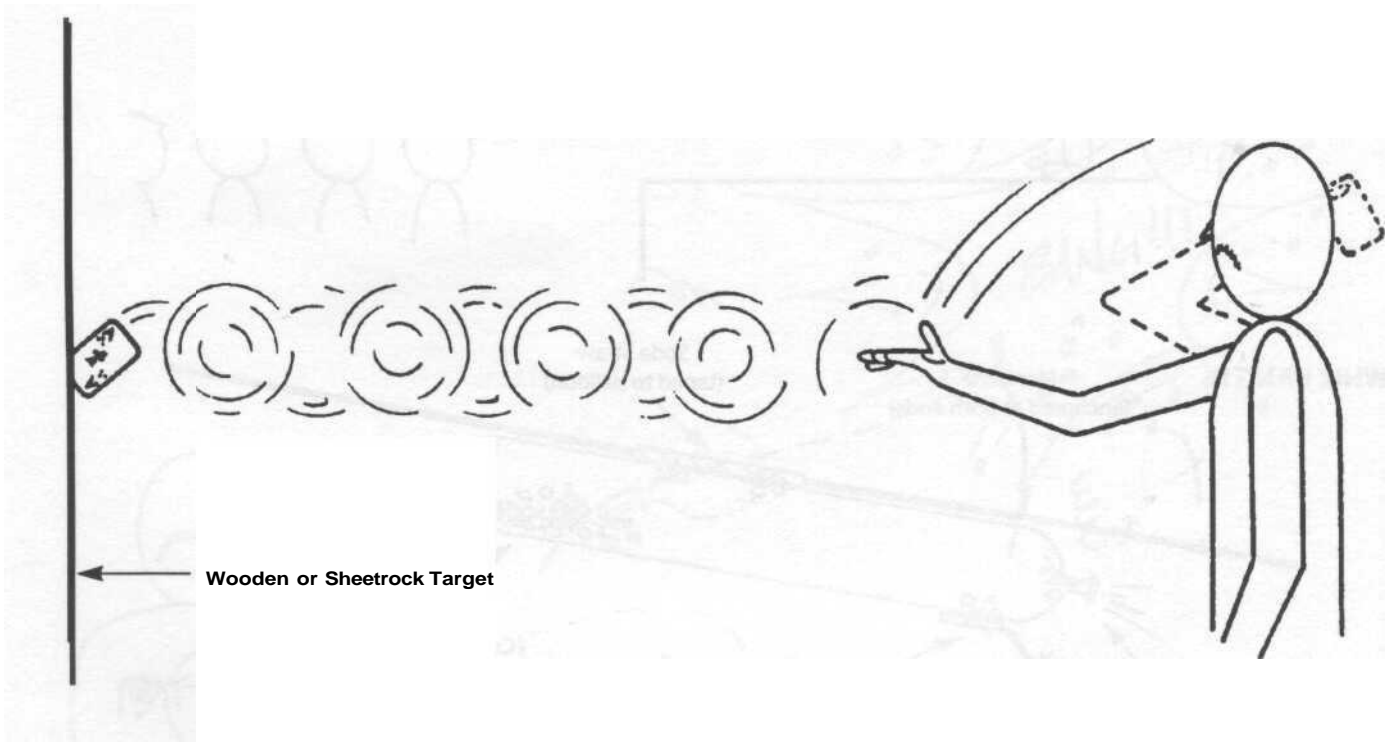

1/16" Sheet Steel Cut in Shape of Playing Card

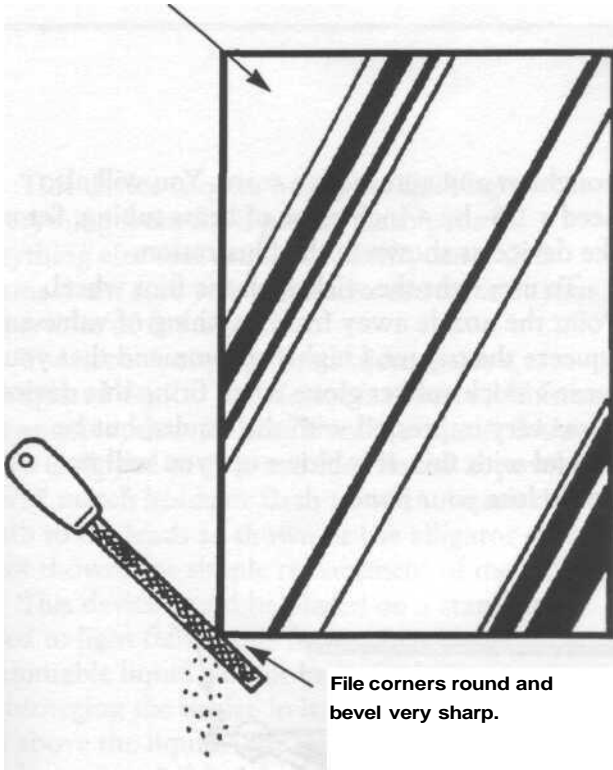

Trim edges from two cards and glue one to front and one to back.

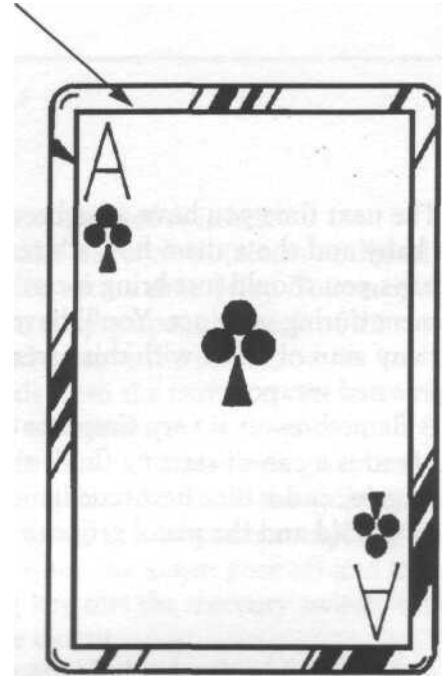

Finished Product

FLAMETHROWER

The next time you have a barbecue, whip out this baby and show them how it's really done, or perhaps you should just bring it out at a dull moment during your act. You'll have no need to fear any man or beast with this awesome piece of improvised weaponry.

A flamethrower is very simple to build. All you need is a can of starting fluid, a spray can pistol grip, and a flint barbecue ignitor. The starting fluid and the pistol grip can both be

bought at any automotive store. You will also need a 1/8- by 4-inch piece of brass tubing. Set up the device as shown in the illustration.

To use, light the wick with the flint wheel. Point the nozzle away from anything of value and squeeze the trigger. I highly recommend that you wear a thick rubber glove when firing this device. I was very impressed with the results, but be careful with this. If it blows up, you will no doubt lose your hand.

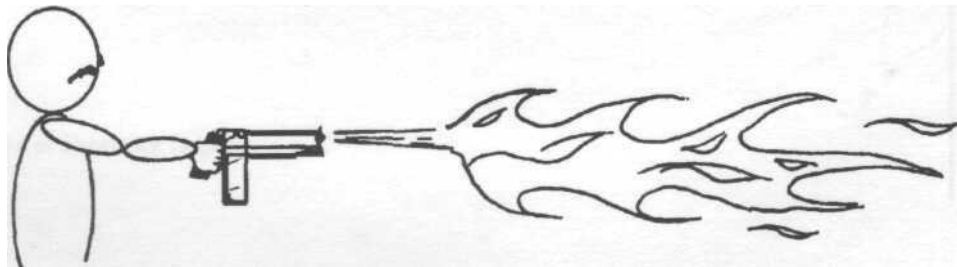
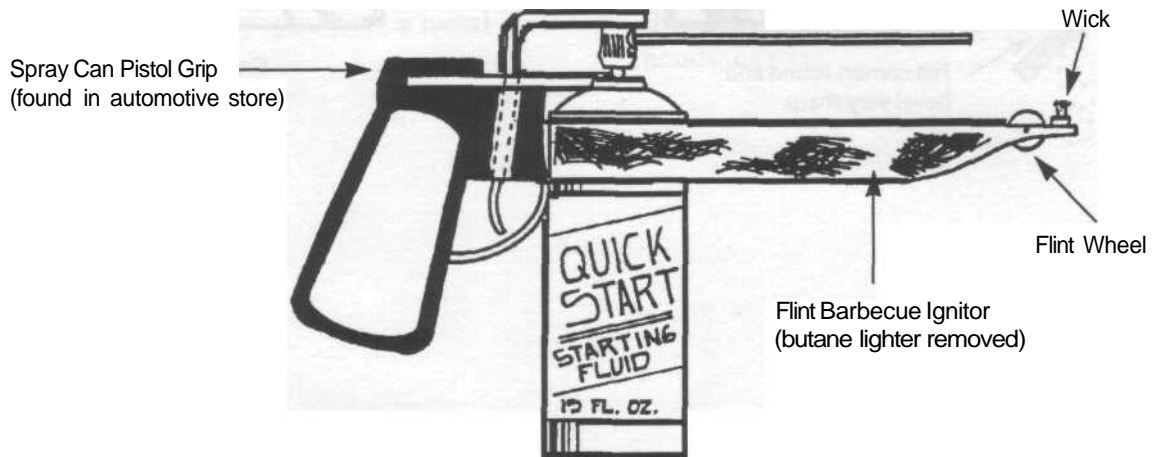

IGNITOR

This device is quite handy for igniting everything from flash pots to flash pans to anything else that requires a swift, concealed flame. I am sure you will find a use for it in your repertoire of fire magic.

The accompanying illustration shows a completed device. The device is constructed from an antenna, thus making it collapsible. A flashbulb is dipped in glue and then rolled in powdered match heads or flash powder. Attach the bulb to the leads as shown or use alligator clips (not shown) for simple replacement of the bulb.

This device could be placed on a stand and used to light flammable fumes. Remember, flammable liquid cannot be ignited by submerging the device in it. The flashbulb must be above the liquid. The ignitor could be placed under your watchband and brought out to ignite a flash pan or secured farther up your arm with a dog collar.

The example in the illustration is fired by using a toggle switch, but a number of methods work just as well. Your local hobby shop or Radio Shack store

can provide a multitude of switches.

You could also use a clock (alarm or digital) to fire the device with a time delay. To attach it to a digital alarm, simply open the back of the plastic case and remove the piezo from its leads. Attach the leads from the ignitor to these. Device completed. To use an alarm clock, place a mercury switch on the alarm winding key and set the alarm. Attach the leads from the ignitor to the mercury switch, and the ignitor is complete. This setup will fire when the alarm goes off and the alarm winding key tilts the mercury switch, thus completing the circuit.

The device could also be fired by remote control. Attach the leads from the ignitor to a microswitch. Depress the servomechanism against the microswitch to fire the device. A servomechanism, complete with hand-held control unit, can be found in any remote-controlled car, boat, or plane. The servo units can also be bought separately from a good hobby shop for a lot less than the complete toy model.

Device Strapped to Forearm with Dog Collar

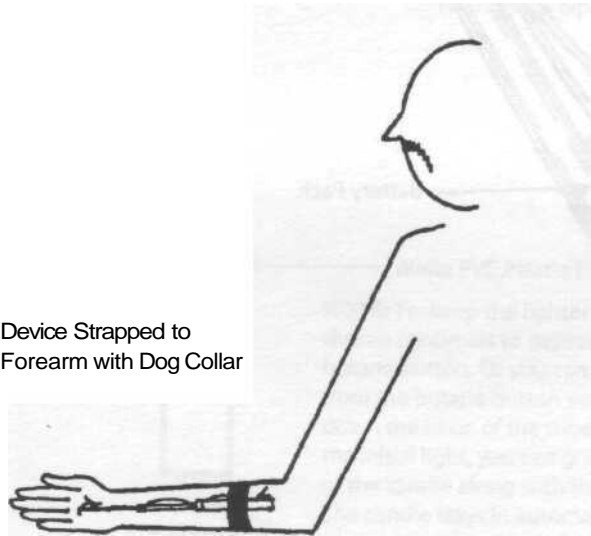

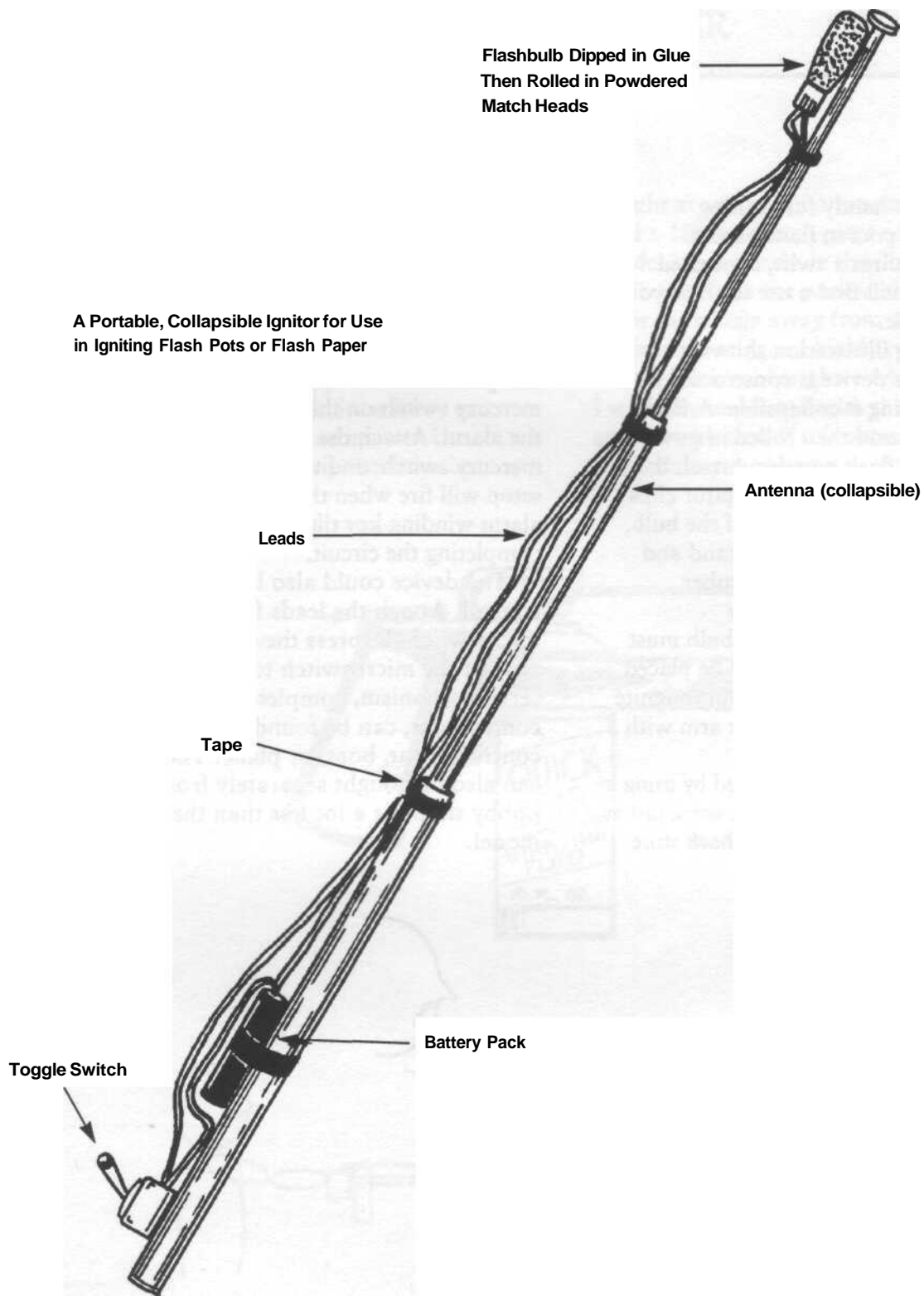

LIT CANDLE FROM COAT

I could have marketed the following trick and made a mint, but I thought I would throw it in this book because it is so neat. This is the least dangerous of all the fire devices in this book, but you'll probably use it in every show.

We all know how the original "candle from the coat" works. Remember the match stuck down beside the wick and then struck on a striker inside your coat just prior to bringing it out, like striking a giant match? Well, friends, my new and improved method makes this old way obsolete. And it is much safer. I also can boast that, although most tricks don't, mine works every time!

Through the miracle of space-age materials, we now have the disposable plastic lighter, and

that, along with a 12-inch piece of plastic PVC tubing, is all you need to construct this device. You need to cut a notch in the tube at one end to allow you to light the lighter. Once the notch is cut, shove the lighter in the tube and make sure the flint wheel and butane button rest in the notch. With this done, you now have what will pass for a self-lighting candle. Place this candle in your left inside breast pocket, and you are set to perform. During your act, reach in your coat, pull the coat away from your body with your left hand, light the lighter, and pull out the pseudo candle. The audience will think you have just pulled a lit candle from your coat. Quite impressive.

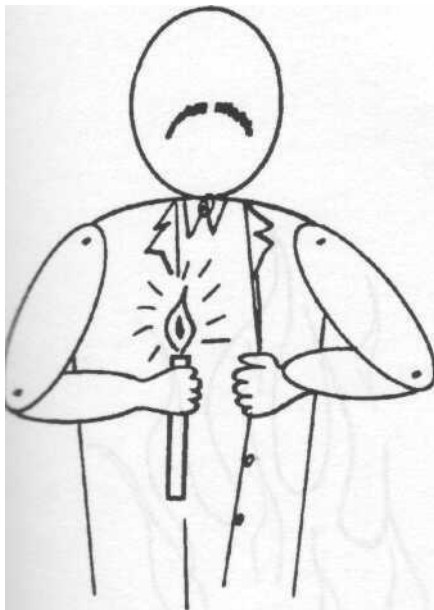

CONSTRUCTION OF THE TRICK CANDLE

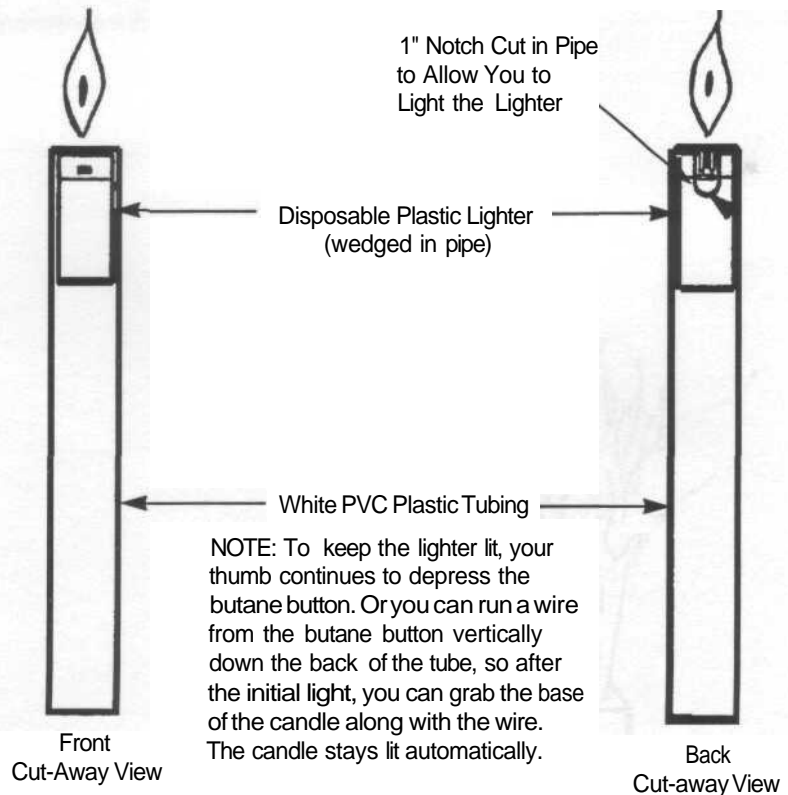

FLASH POTS AND FLASH PANS

Every magician should be familiar with flash pots and flash pans because they have many uses in stage magic. The two devices shown in the illustrations are the most reliable electronic flash units you can build.

The flash pot contains two flashcubes inset into the bowl and covered with flash powder. Each cube is connected to a separate power system (only one is shown in the flash pot illustration), so you have a back-up firing system in case one fails. The device is fired with a toggle switch. Always use a flammable powder, not liquid, in the pot. Flash powder is best. If you use gun powder, use black powder, not smokeless powder.

Nothing will get your spectators' attention faster than a fire trick, and a flash pan is just the

device to accomplish this. Again, this device uses two independent firing systems in case one fails. Dip each of the flash cubes in glue and then roll in match heads. Use a toggle switch to fire each device and a flammable liquid, such as lighter fluid. Saturate the bottom of the pan just prior to its use. Glue a piece of heavy cardboard to half of the inside of the pan to soak up the lighter fluid. The flash pan itself is usually made of brass.

The flash pan can be fired using methods other than electronic ignition. You could also use a sparkless chemical mixture. There are many chemical mixtures that result in spontaneous combustion when two chemicals are brought together, but hypergolic mixtures are not reliable, so I strongly discourage their use in magic.

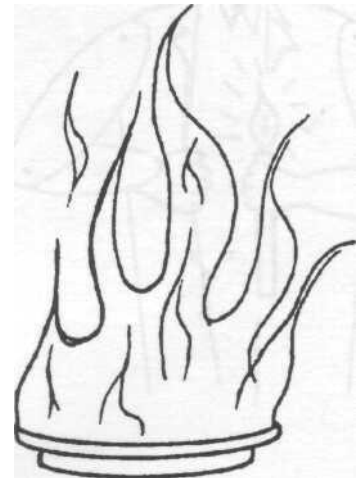

TOP VIEW

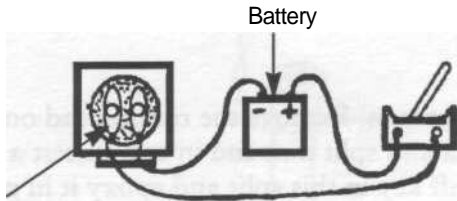

Flash Cubes Inset
in Flash Powder
in Metal Pot

TOP VIEW

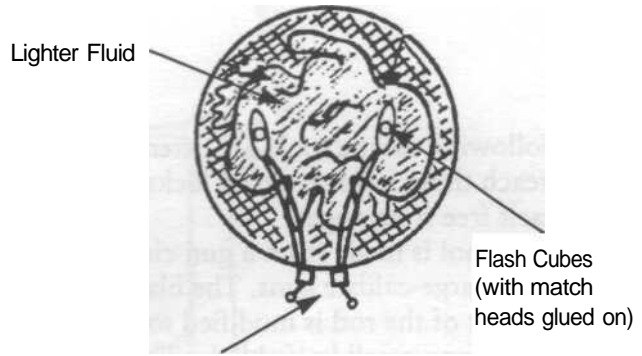

Toggle Switches
and Batteries

FRONT VIEW

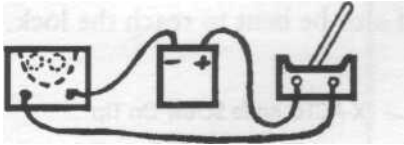

FRONT VIEW

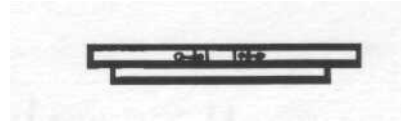

Both of these devices use two independent systems; in case one fails, you have a backup.

ESCAPE TOOLS

The following escape tools are extensions for keys to reach those hard-to-get-at locks and to cut yourself free from ropes.

The first tool is made from a gun-cleaning rod intended for large-caliber guns. The blade-holding chuck of the rod is modified to hold a handcuff key or a small knife blade. The tip comes from an X-ACTO knife. It screws right onto the end of the rod. The rods may be hidden on your body or in a box or bag from which you are attempting to escape. This tool will allow you to open some difficult locks.

The second escape tool is made from a car or

radio antenna. Remove the round head on the antenna and split that end in two. Insert a handcuff key in this split and epoxy it in place. You also need to flatten the antenna slightly with pliers or in a vise. This will prevent the tubes from rotating inside each other, and the handcuff key will now stay in place. On some antennas, the last rod is only a piece of wire and will not flatten. In this case, you will need to remove this wire and split the second tube (or rod). This escape tool is used much the same way as the first, as an extension to reach a lock. The antenna could also be bent to reach the lock.

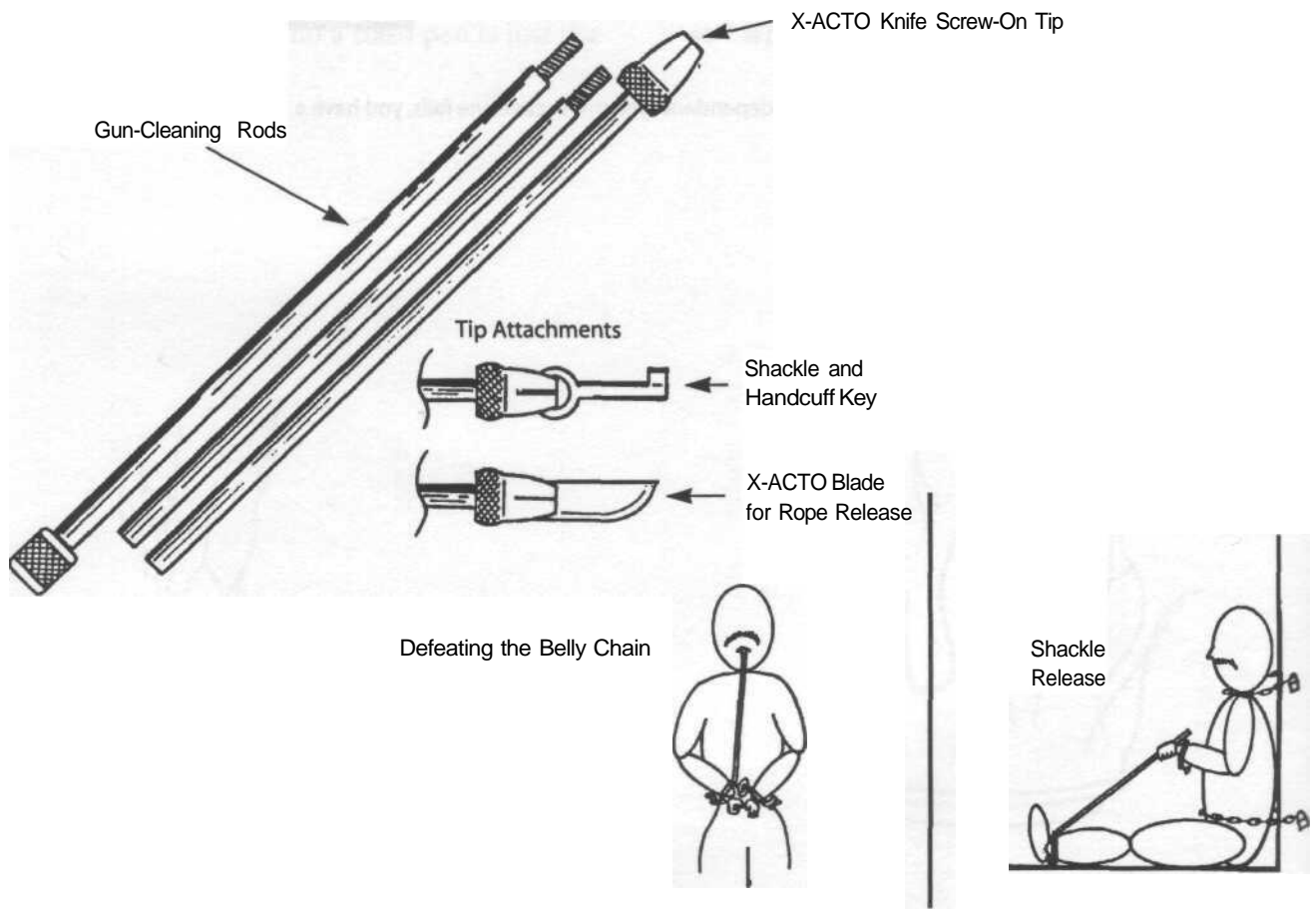

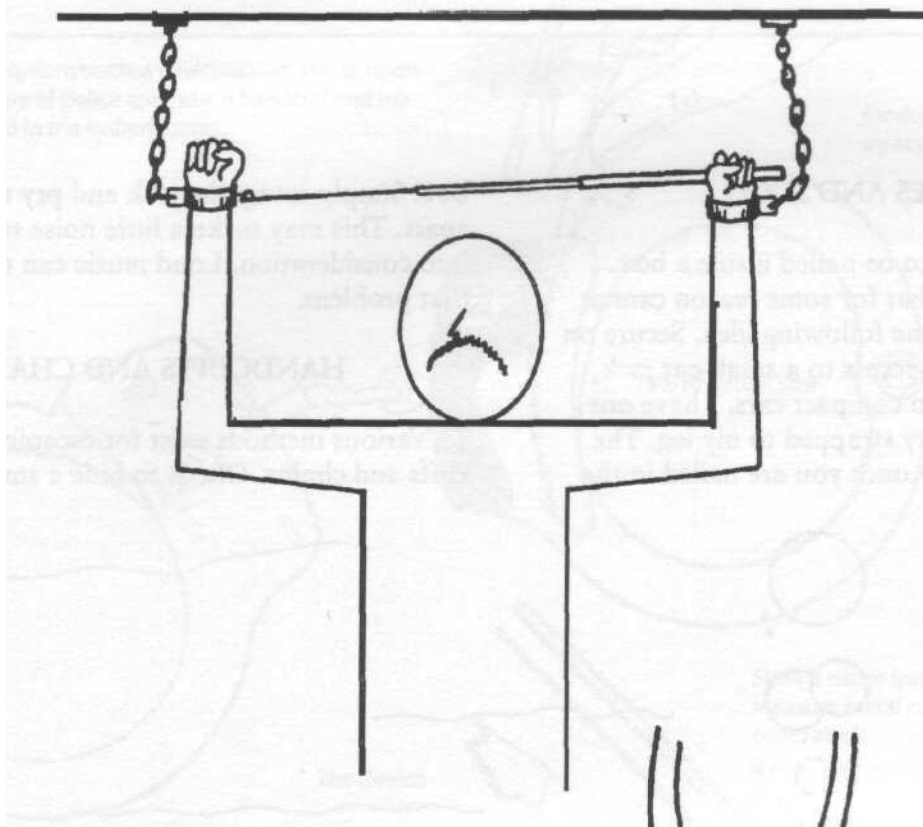

Crush antenna with pliers, thus preventing the metal tubes from rotating inside each other.

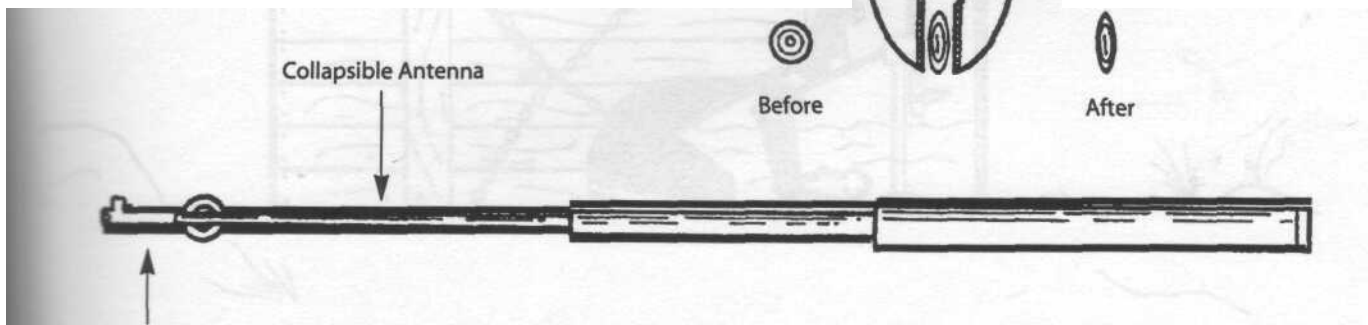
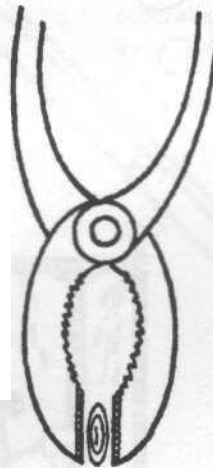

Affix a handcuff key to the end of antenna.

WARNING: THE EFFECTS AND DEVICES IN THIS BOOK ARE EXTREMELY DANGEROUS AND SHOULD BE UNDERTAKEN BY TRAINED PROFESSIONALS ONLY. THIS MATERIAL IS PRESENTED FOR INFORMATION PURPOSES ONLY.

ESCAPE TRICKS

BOXES AND SUCH

If you are going to be nailed inside a box, barrel, coffin, etc., that for some reason cannot be gaffed, consider the following idea. Secure on your person or gain access to a small-car jack, e.g., the type used on compact cars. I have one small enough to carry strapped to my leg. The jack comes into play once you are nailed in the

box. Simply set up the jack and pry the box apart. This may make a little noise so take that into consideration. Loud music can take care of that problem.

HANDCUFFS AND CHAINS

Various methods exist for escaping from handcuffs and chains. One is to hide a small pair of

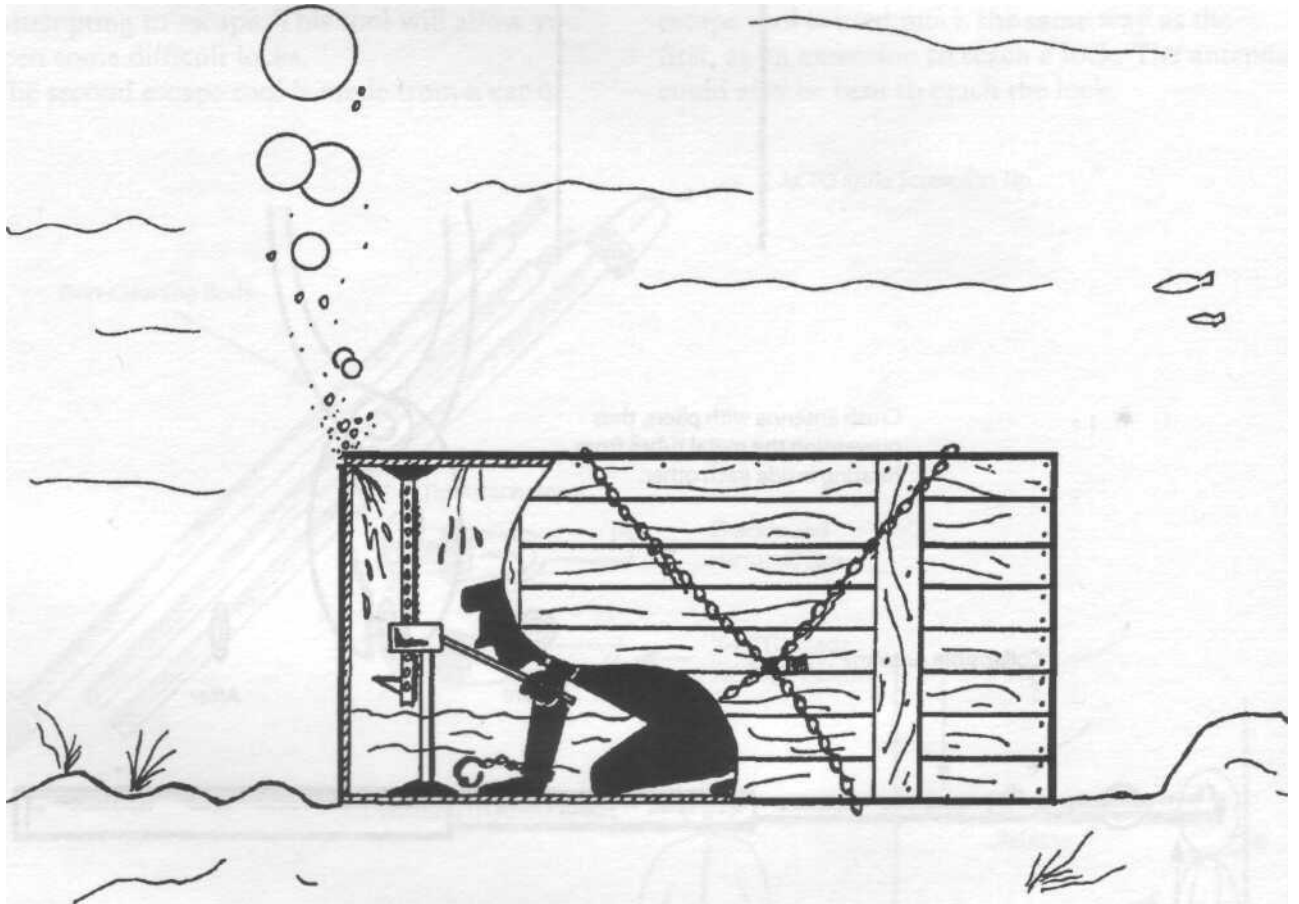

A small automobile jack aids the escape artist in freeing himself from the crate. This works equally well on barrels, coffins, etc. A car jack can be used to open any door by simply spreading the door jam.

This easily constructed device allows you to open every type of police and prison handcuff and leg iron used in the United States.

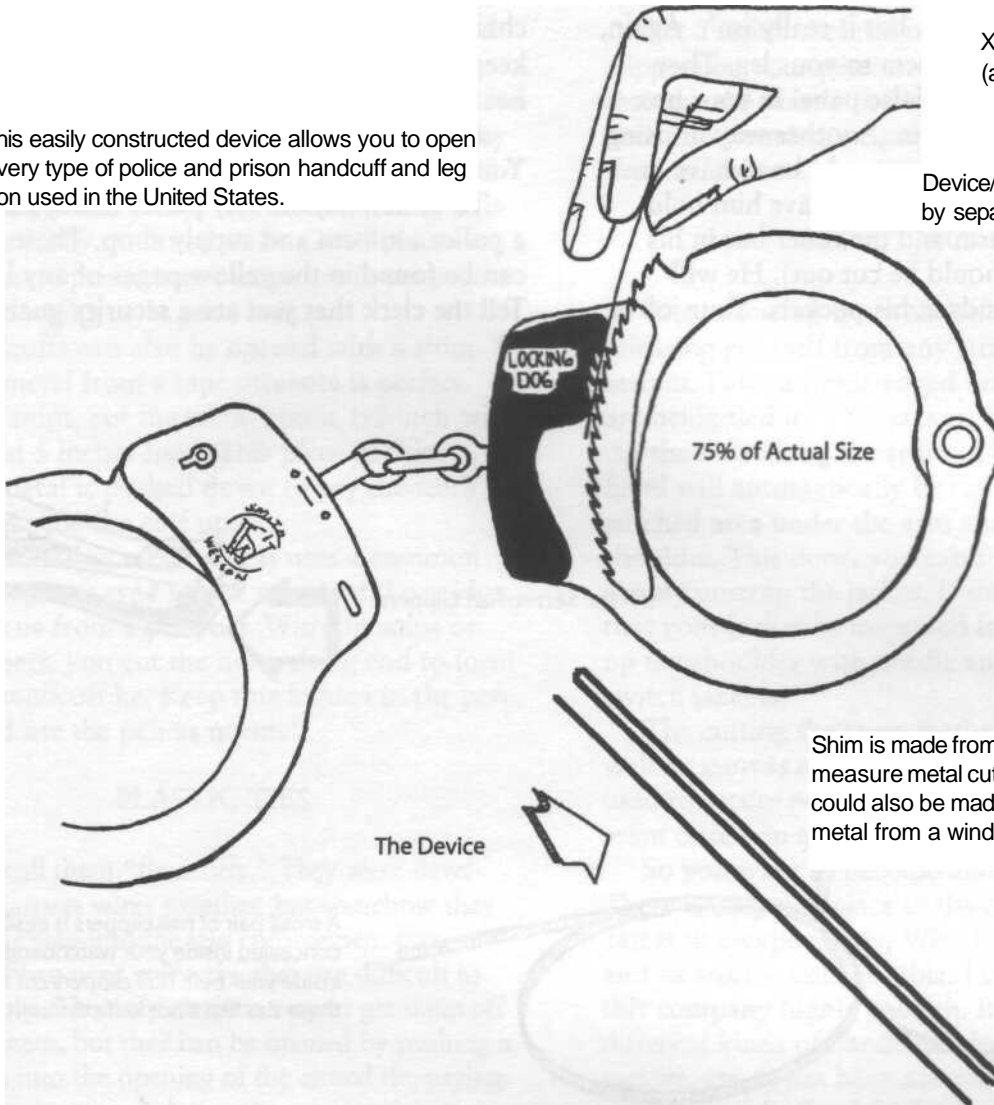

X-Ray View of Ratchet
(aka, locking dog)

Device/Shim (opens the cuffs
by separating the ratchet)

NOTE: Place a
small solder plug
over the "push
lock" hole on
the side of the cuff to
prevent the cuffs
from being
double locked.

Shim is made from a piece of tape
measure metal cut to exact size. It
could also be made from a piece of
metal from a wind-up clock spring.

bolt cutters on your body or within your reach. This may sound difficult, but it really isn't. Again, you may wish to strap them to your leg. They may also be hidden in a false panel in your box or behind a double curtain. Another way of using a small pair of bolt cutters would be to have an assistant hide them in his coat. Have him hold one bar under his arm and the other bar in his hand (the pocket should be cut out). He will stand with both hands in his pockets. Your job is

to get close enough to him to let him cut the chain between the cuffs. Once it is cut, you still keep both hands together pretending that nothing has happened.

Another method would be to switch cuffs. You have to use an assistant for this.

To obtain keys to any police handcuffs, go to a police uniform and supply shop. These shops can be found in the yellow pages of any large city. Tell the clerk that you are a security guard and

The Secret: Nail Clippers

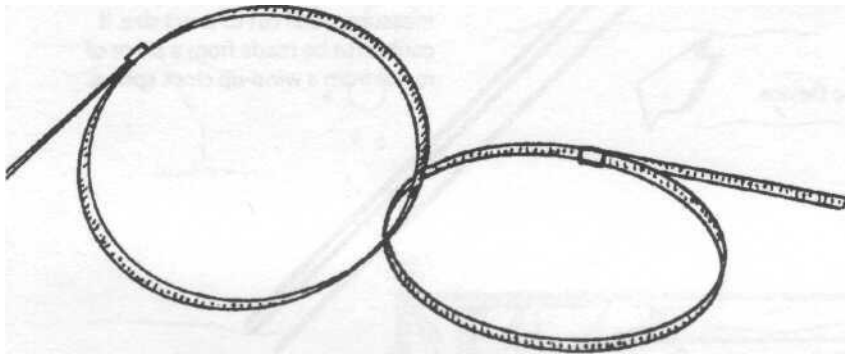
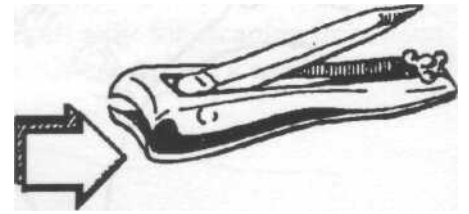

A small pair of nail clippers is easily concealed inside your watchband or tucked inside your belt. Nail clippers cut through these ties like a hot knife through butter!

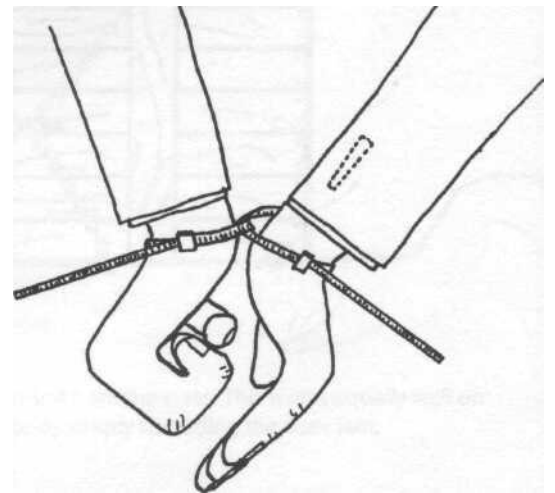

have lost your handcuff keys or that you just want to buy a key. But look the part of a guard. Short hair and a shave are musts. I have never had any trouble using this method. Another good place to buy handcuff keys is a pawnshop. They usually have all sorts of handcuffs and assorted keys. Many jewelry keys will fit handcuffs as is or can be easily modified to fit. Good places to hide the keys prior to an escape are in the seams of your clothing or in your hair.

Handcuffs can also be opened with a shim. A piece of metal from a tape measure is perfect. With tin snips, cut the metal about 1/8-inch wide and about 5 inches long. This piece of thin, flexible metal is pushed down to pry the teeth apart and slide the cuff open.

An interesting method that uses a common writing pen, the type with a metal refill carriage, comes to us from a prisoner. With tin snips or nail clippers, you cut the nonwriting end to form a small handcuff key. Keep this hidden in the pen body and use the pen as normal.

PLASTIC TIES

Cops call them "flexicuffs." They were developed to harness wires together, but somehow they made their way into the law enforcement community. When used correctly, they are difficult to escape from. The only obvious way to get them off is to cut them, but they can be opened by pushing a safety pin into the opening of the closed tie, prying open the tongue, and sliding the other end out.

Another method for releasing yourself is to have them placed on backwards. They still make that little clicking noise, although not as loud. In this situation, they will slide back open with no

effort. This one really works well.

Yet another method is to hide a pair of nail clippers on your person. They will cut right through the plastic ties in an instant, or if the situation permits, a cigarette will readily melt a flexicuff in two.

STRAITJACKETS

The following is a wonderful method for releasing yourself from any straitjacket in an instant. Palm a single-edged razor blade as you are being tied into the jacket. Once you are alone, cut the area along the seam of the jacket. Your hand will automatically be right there. Cut the stitched area under the arm and on around the shoulder. This done, you can free your arm and simply unstrap the jacket. If the trick requires that your jacket be inspected later, you could sew up the shoulder with needle and thread or simply switch jackets.

The cutting the seam method works equally well on canvas mail bags, which are sometimes used to secure people. Simply cut out the bottom seam once you are left alone to work your magic.

So you want to become another Houdini? There is only one place in the entire world that caters to escape artists, Wheeler-Tanner Escapes, and its stuff is unbelievable. I cannot recommend this company highly enough. It has dozens of different kinds of handcuffs, leg irons, straight jackets, etc. It has been around since 1937 and is very reputable. Send \$2 for a catalog to:

Wheeler-Tanner Escapes
3024 E. 35th
Spokane, WA 99223

THERMITE ESCAPE METHODS

As with most of the contents of this book, the following is material that has never been put into print. Thermite is something few people even know about, much less consider its applications. Thermite will burn through the hardest metals on earth with no problem at all. It burns at a rate of 8,000 to 10,000° E The cleverest of criminals have used it to burn holes in bank vaults. It's much faster than a welder's torch.

Thermite is easy to make at home. You will need to obtain two items from a chemistry shop: iron oxide and aluminum powder. Mix three parts iron oxide with two parts aluminum powder. Pack it in the desired container. I use 2-inch diameter PVC with end caps. A piece about 5 inches long is about right. I sometimes use a baby food jar for storing the stuff for an extended period of time.

You can't ignite thermite with a match or lighter. A welder's torch or a small propane torch must be used. Needless to say, the stuff is pretty safe to store.

I first witnessed its use with a friend who smuggled a thermite device off a military base in California. The marines have these devices ready-made for their own use. We went out to the desert and found an abandoned car that was pretty much intact. My friend set the device on the hood of the car and lit it. An intense flame could be seen for a couple of seconds, and the device dropped through the hole it made in the hood. In about a minute it ate through the 360-cubic-inch engine and dropped on the ground. The damn thing ate a hole in the ground and vanished. God only knows how far it went into the earth. This is how powerful thermite can be. That device was about the size of two cans of beans. We won't need that much thermite for our purposes here. I use the above example to reinforce your trust in what we are discussing—

and to alert you to thermite's power.

The accompanying illustration shows a thermite kit made from easily available materials. The example shows only one use of thermite for escape purposes. The escape artist with an imagination can come up with many more uses I'm sure.

OK, now we are going to discuss a real "top secret." I'm going to give away to you, my valued audience, some information the feds want to keep as quiet as possible. How you use this information is up to you.

Someone has been going around the United States for the last 10 or so years lighting fires, but not just any fires. The "Unsolved Mysteries" TV show (the author's favorite show) called this guy the "King of Arsonists"! He is using an accelerant that leaves no trace after it burns. A normal fire burns at around 1,000° F. The fires this guy is setting burn at no less than 8,000°. The arson investigators scratched their heads for years trying to figure what the hell this guy was using. Then a fireman got killed during one of these blazes, and they intensified their investigation. It's like a cop being killed: it becomes personal. They will track your hide to the ends of the earth until you're caught. The investigators knew it had to be a commonly available chemical, and it was. They experimented for months with various combinations before finally hitting it. The guy was using rocket fuel. Yep, that's the big secret: rocket fuel. The stuff burns so hot it vaporizes bricks. "Unsolved Mysteries" showed some of this guy's handiwork, and it was the scariest sight I've ever seen. I have written two books on homemade bombs and visited many burned-out and blown-up scenes, but I had never seen anything like this.

Rocket fuel is easy to procure. It is used as race car fuel and has many other commercial

uses. Below is a list of various rocket fuels that can be bought easily with no identification required:

- Nitromethane
- 2-Nitropropane
- Hydrazine perchlorate
- Methyl nitrate
- 1-Nitropropane

- Sodium nitrate
- Tetranitromethane
- Ethyl nitrate

A visit to your local library or, even better, a college engineering library can provide you with information about rocket fuel.

1. Thermite will burn through anything on earth—anything!
2. It does the same thing to concrete and bricks.
3. Thermite is very easily manufactured at home.

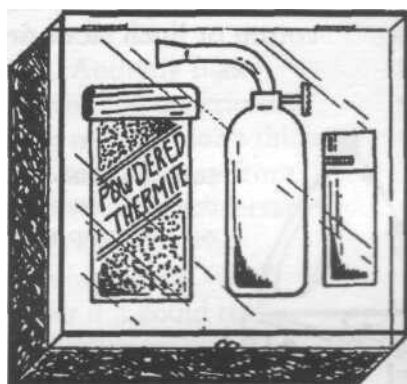

Homemade Thermite Kit Contains the Following:

- 1 Butane Lighter
- 1 Miniature Propane Torch (available from Radio Shack or hobby shop)
- 1 Bottle of Thermite (available at chemistry or hobby shops)

How to Make Thermite:

- 3 Parts Iron Oxide
- 2 Parts Aluminum Powder
- Mix

NOTE: See back of *Popular Science* Magazine for a list of mail-order chemistry suppliers.

How Thermite Could Aid an Escape

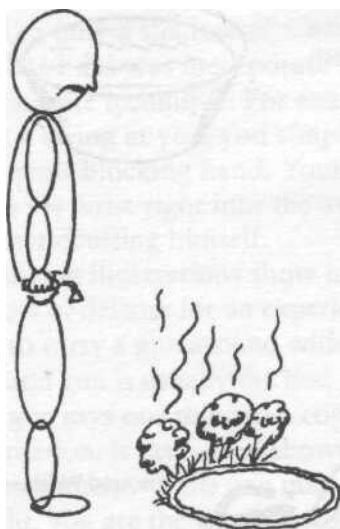

A. Thermite poured in a circle and lit with torch.

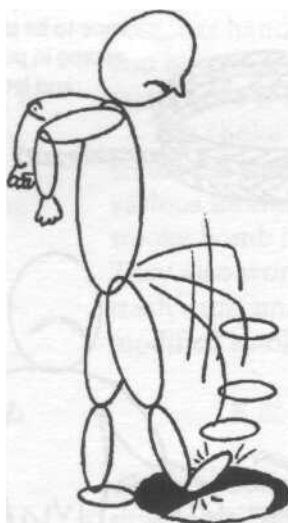

B. Kick out section of floor.



C. The escape!

WARNING: THE EFFECTS AND DEVICES IN THIS BOOK ARE EXTREMELY DANGEROUS AND SHOULD BE UNDERTAKEN BY TRAINED PROFESSIONALS ONLY. THIS MATERIAL IS PRESENTED FOR INFORMATION PURPOSES ONLY.

ROPE WORK

I have never seen a reference to this trick in any escape material. I found this magical secret out by accident. The secret is liquid sodium hypochlorite-based bleach.

Soak a length of cotton rope in pure bleach and let it dry completely. That's all there is to it.

Let someone tie you up with this rope. Instant-

ly, you can release yourself by twisting the rope. It will snap and break with hardly any effort.

You may wish to soak only part of the rope if you are using a long piece. Just be sure you know which is the weak portion of the rope.

This method may be used on any sort of cotton or linen cloth ties.

NOTE: If you are sensitive to bleach or are concerned about getting sodium hypochlorite powder in your eyes, cotton rope can also be weakened at a given point with *weak* sulfuric acid. Let it work for a few minutes, then wash it out and soak that portion in a baking-soda solution. It will slightly discolor white cotton, but this can be hidden by rubbing chalk powder on the discolored section. Hemp or sisal rope can be weakened with a weak solution of ferric chloride in the same manner.



Soaking a rope in bleach totally destroys the strength of the rope. It will easily snap at any desired point.

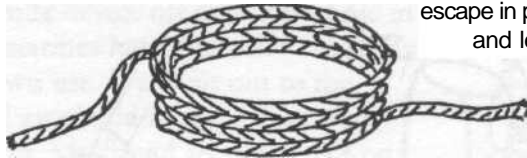

Soak all or part of the rope to be used in the escape in pure bleach and let dry.

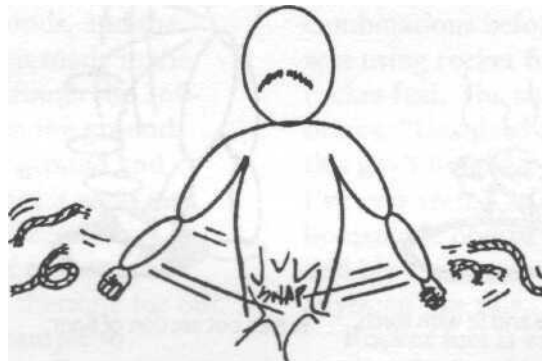

Bound Wrists—Instant Release

MAGICIAN'S ESCAPE-AND-EVASION KIT

It seems ironic that as I write this, the Sci-Fi Channel is showing reruns of the 1973-74 television series "The Magician" with Bill Bixby. I was a magician 10 years before that show aired, but it provided more inspiration—to me as well as to many of today's professional magicians—than any other television show to date.

In the show, the magician, Anthony Blake (Bixby), was constantly overcoming the criminal element with his clever use of magic. I don't think he ever used a gun, unless he took it away from the bad guy. He always handcuffed his adversary to something or to another bad guy. It was absolutely hilarious to watch his use of misdirection. I used to wonder if it could really work that simply. And to my surprise, it did.

People were caught so off guard when I applied the handcuffs that they did not know what to think. Now I'm not talking about handcuffing my grandmother; I'm talking bar fights. At one time, I was very proficient at Chinese kenpo karate. I still remember the techniques, but I'm only a shadow of what I was 15 years ago. What I did was incorporate the handcuffs into a karate technique. For example, if the guy is taking a swing at you, you simply have the handcuffs in your blocking hand. Your opponent throws his wrist right into the awaiting cuff, practically handcuffing himself.

The accompanying illustrations show my recommended lines of defense for an experienced magician. I used to carry a gun around with me.

While it's true that a gun is usually the best personal weapon, a gun says one thing to a cop if you get into a confrontation. It says—and shows—intent, premeditated intent. While you may very well be in the right, you are the person who is going to have to prove why there is a dead guy with a head full of bullets slumped over the barstool.

Every item depicted in the next illustration

shows a strictly defensive intent on your part. The most important item is the personal defense spray, often erroneously referred to as Mace. Several years ago, a new form of this spray was introduced on the commercial market. It contains a derivative of the hottest pepper there is. I have personally stopped two guard dogs coming at me full speed dead in their tracks (never mind what I was doing in the museum at 2:00 A.M.). The stuff will stop the most aggressive human on earth. There are several different brand names for this oil of capsicum spray, and it is now widely available in gunshops and sporting goods stores.

The handcuffs can be used in the obvious ways or more creatively if you have an imagination. The long chain handcuffs are my favorite. They work best when you are trying to handcuff the bad guy to something. First, he should never even know you have the handcuffs in your possession until it's too late and he has at least one hand restrained. It's best if you can already have one cuff secured around something like a post, car handle, tree branch, etc.. This way all you have to do is apply one cuff to his hand and retreat. He is stuck and mad as hell.

The choke chain and padlock are used to secure his legs. The smoke bombs and other various incendiary devices are used in evasion. A smoke bomb in a closed room will create havoc. They also work great for misdirection, such as in trash cans, under cars, etc. We will examine a modified smoke bomb and chain next.

E & E TACTIC (OFFENSIVE)

These devices should only be used in the worst of situations. The choke chain has been modified by placing fishhooks at the points shown. The smoke bomb also has fishhooks glued or taped on it.

The chain is applied quickly to the legs of the

subject. As soon as the chain whips around his legs, the fishhook on the end digs into his left pant leg. From here you simply tighten the chain as best as you can and let the fishhook that is close to your hands also dig into his left pant leg. That prevents him from running after you. By the time he removes the fishhooks, you're long gone (unless, of course, he wants to take off his pants and run after you, which is doubtful).

You can leave it at that or go a step further. The bad guy thinks he has problems now, but he ain't seen nothing yet. You remove a small PVC pipe from your coat and remove one end cap. From there you light the fuze of a smoke bomb inserted in the pipe. This is done with an ingeniously rigged butane lighter taped to the side of the pipe. You release the lit smoke bomb directly onto his clothes, and it sticks to him. A lot of things run through the bad guy's mind at this point. The illustration shows how to construct the chain and smoke bomb. These items are very dangerous, so use common sense.

E & E TACTIC (DEFENSIVE)

Here the magician is prepared for a confrontation with his assailant. You, the magician, clip the personal defense spray to the inside of your forearm. (Small cans usually come with a pocket clip attached.)

You spray the subject in the eyes with the spray. Then you release the pouch on your belt containing the choke chain and padlock. Kneel down and whip the chain around his legs tightly and padlock it shut. The subject is busy trying to

get the chemical out of his eyes, so he won't give you too much trouble when you chain his legs together. If he does, you're in a great position to rack him.

After chaining his legs, you have the option of leaving him as is or continuing your beating. It is my personal opinion that if you get in a fight it should be to the death, so let us continue.

Stand up directly in front of him and deliver a hard side kick to his stomach while gouging out his eyes. "Think of it as crushing grapes with your fingers," my martial arts instructor used to say. From here, the now-defeated aggressor will be lying on his side, front, or back. If he is on his back, jump up and land on his throat with both heels. No air, no life—it's that simple. I'll tell you an extremely well-kept secret in black belt karate: if you are going to kill someone with your hands or feet, the attack must center around the throat and neck. Think of the windpipe as a garden hose. If it kinks, no water comes out. If the windpipe is crushed, no air passes through, and the subject expires in short order. If the guy has landed on his stomach or side you will need to jump up and land on his skull, thus crushing it, or you can land on his neck and sever his spine from his head. Either way, you've just killed him.

I know I speak of death in a matter-of-fact manner, but we live in a violent society and there is no way around it. If someday you or someone you love is in a prison camp in some God-forsaken country with nothing but knowledge and a will to survive, taking a human life to escape death is reason enough for me to publish this kind of material.

UTILIZING CLEVERNESS RATHER THAN FIREPOWER TO OVERCOME AN ADVERSARY

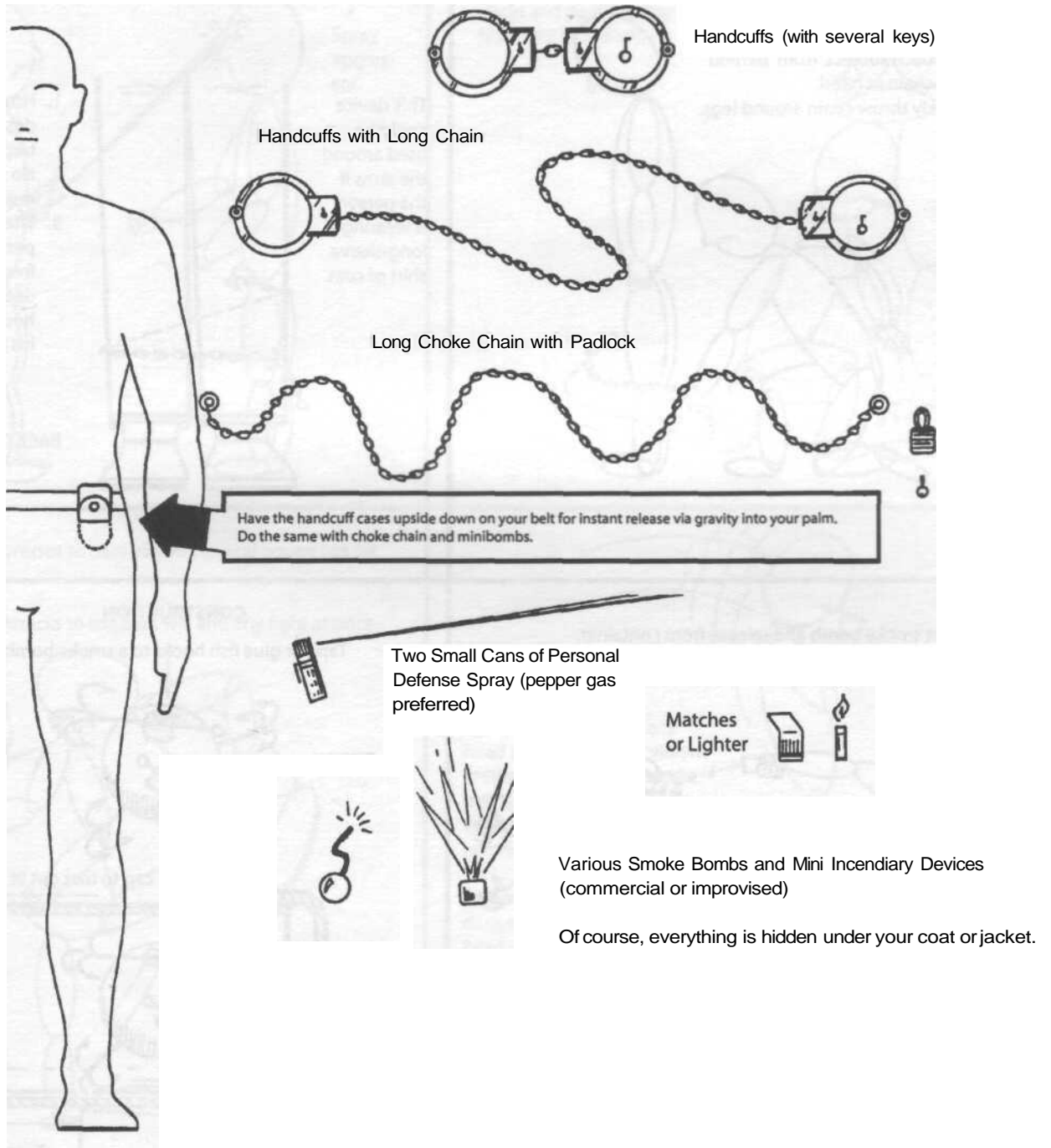

WARNING: THE EFFECTS AND DEVICES IN THIS BOOK ARE EXTREMELY DANGEROUS AND SHOULD BE UNDERTAKEN BY TRAINED PROFESSIONALS ONLY. THIS MATERIAL IS PRESENTED FOR INFORMATION PURPOSES ONLY.

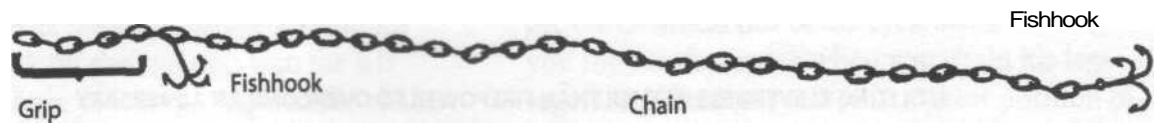

1. Approach subject from behind with chain in hand.
2. Quickly throw chain around legs.

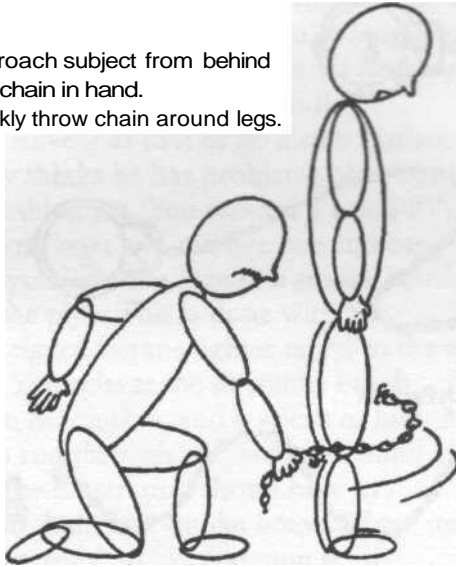

This device could be used around the arms if the person is wearing a long-sleeve shirt or coat.

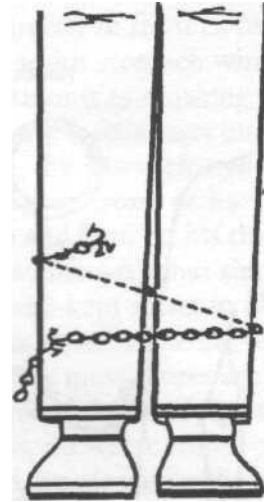

1. How the specially designed chain traps the legs.
2. No padlock required.
3. The more the person tries to free himself, the deeper the fish hooks dig into his pants.

BACK OF LEGS

1. Light smoke bomb and release from container.
2. Smoke bomb will attach itself to subject's clothing.

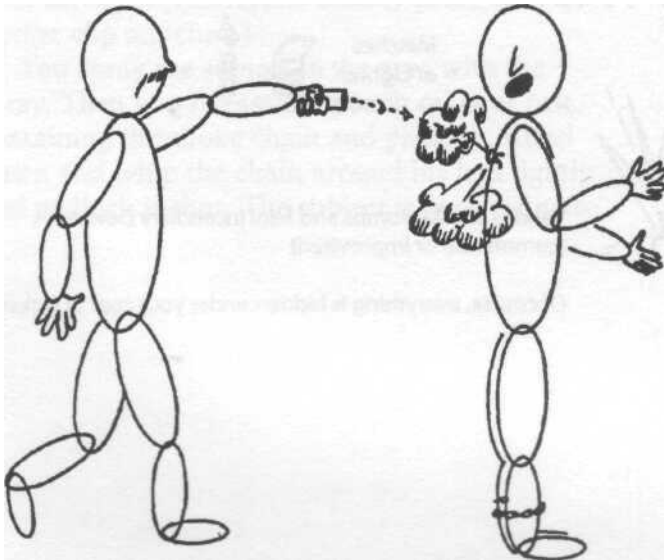

CONSTRUCTION

Tape or glue fish hooks to a smoke bomb.

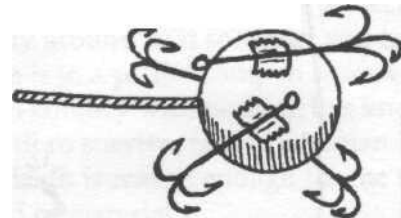

Open end cap to toss out lit device.

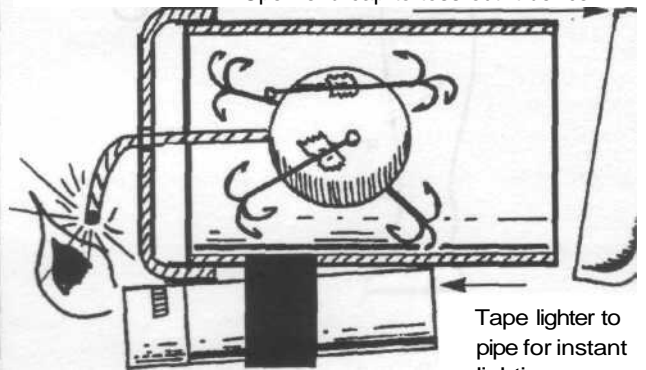

Tape lighter to pipe for instant lighting.

PVC pipe with end caps is the transport case for this device.

Spray Clipped to Watchband

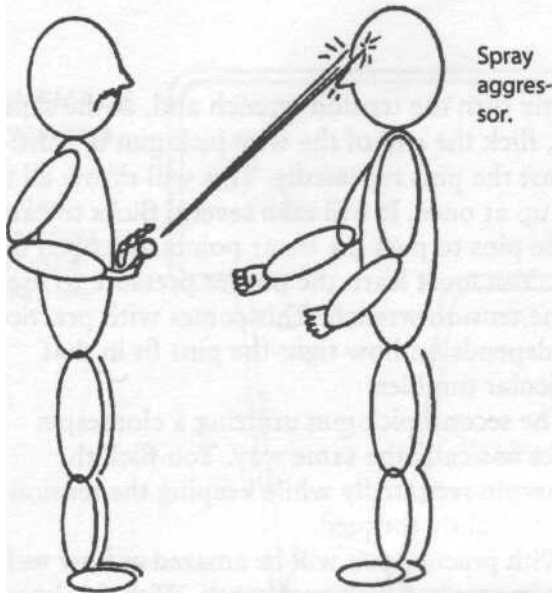
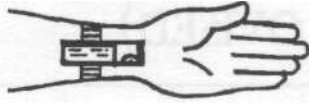

B.
Tie his legs together with the choke chain and padlock. Apply handcuffs to his wrists (optional).

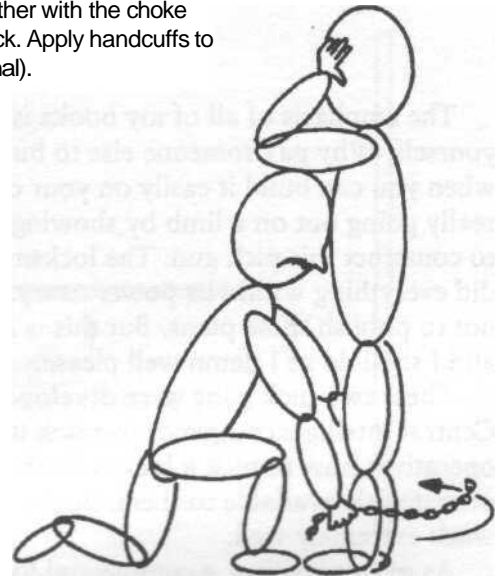

C.
Kick aggressor as hard as you can and gouge out his eyes.

NOTE: Attacks to the eyes will end any fight at once.

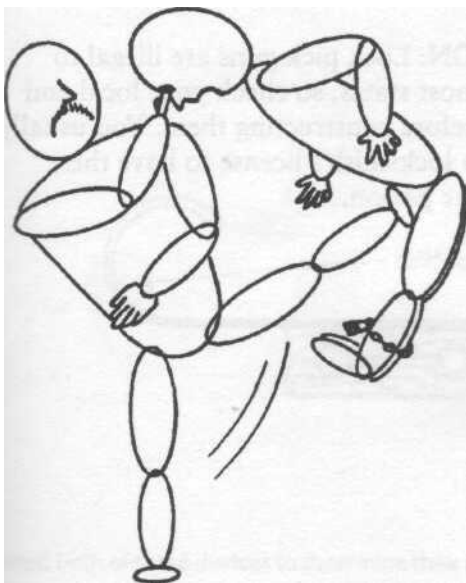

D.
Optional: Coupe de grace head stomp. This very violent method is a standard black belt killing technique. Jump, stiffen legs and body prior to landing on his head.

WARNING: This is extremely dangerous. Your opponent's head will be crushed by your body weight.

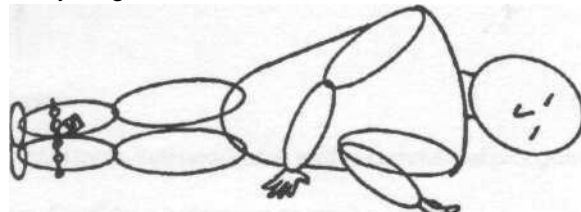

LOCK PICK GUNS (IMPROVISED)

The emphasis of all of my books is to do it yourself. Why pay someone else to build a device when you can build it easily on your own? I am really going out on a limb by showing you how to construct this pick gun. The locksmith trade did everything within its power to try to get me not to publish these plans. But this is America, and I shall do as I damn well please.

These two pick guns were developed by the Central Intelligence Agency to teach its field operatives how to pick a lock with the minimum of materials available to them. Both of these guns work extremely well.

As of this writing, a commercial lock pick gun costs about \$100 to \$150. The two improvised pick guns here cost about \$.50 to build and do exactly the same thing as the commercial guns do. I have tested both of the improvised guns against the commercial guns and have achieved the same success with all of them: I have always gotten the locks open.

Most escape artists are familiar with the methods of picking locks, so I will be brief about explaining how to use these two devices.

To use the first gun, insert the end of the wire into the lock along with the tension wrench.

Lightly turn the tension wrench and, at the same time, flick the end of the wire pick gun upward against the pins repeatedly. This will throw all the pins up at once. It will take several flicks to cause all the pins to pass the shear points and open the lock. You must learn the proper pressure to use on the tension wrench. This comes with practice and depends on how tight the pins fit in that particular tumbler.

The second pick gun utilizing a clothespin works basically the same way. You flick the clothespin repeatedly while keeping the tension wrench lightly torqued.

With practice you will be amazed at how well these improvised pick guns work. With this knowledge of how to construct these lock picks, you will seldom run across a lock you cannot pick. This gives a real sense of power and self-confidence. Just remember: practice, practice, practice. Don't get discouraged. You will learn the art.

CAUTION: Lock pick guns are illegal to possess in most states, so check your local and state laws before constructing them. You usually must have a locksmith's license to have these tools on your person.

HOMEMADE PICK GUN I

Wire Coat Hanger Bent into Shape Shown Here

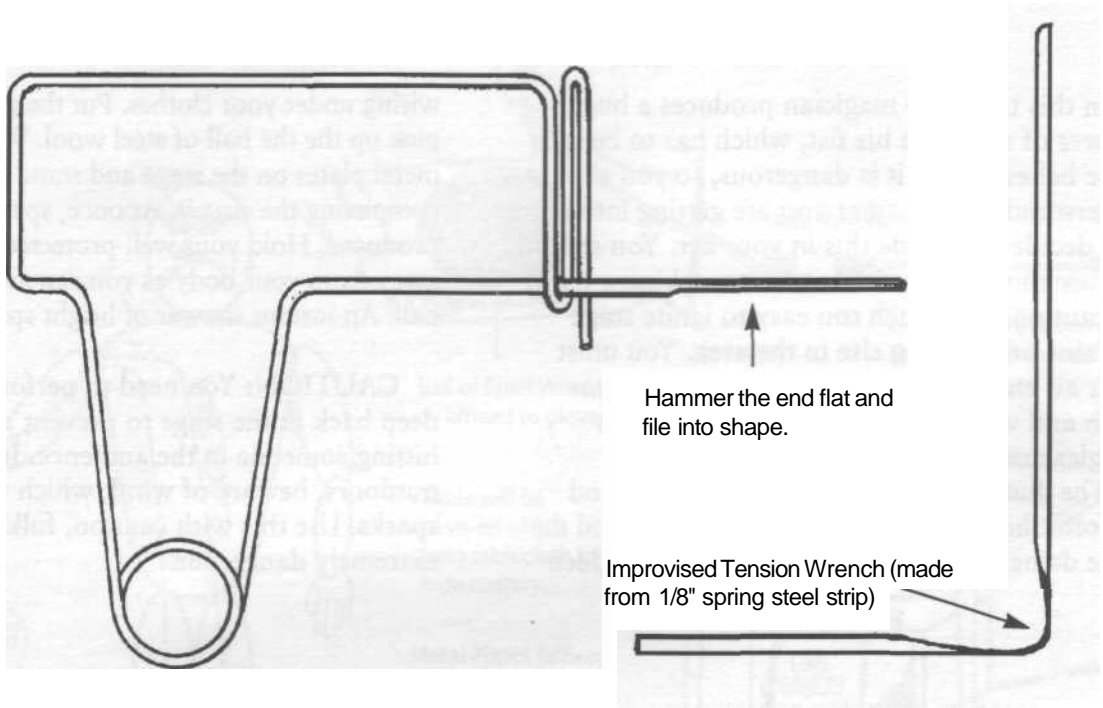

HOMEMADE PICK GUN II

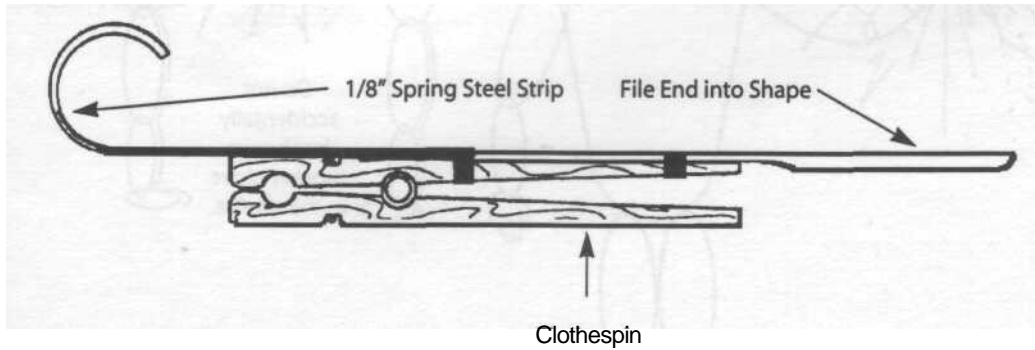

tested both of these devices to determine their ability to pick standard locks. Both worked as well as commercial pick guns.

IMPORTANT: Possession of the above devices is illegal in most states. Check laws before constructing.

WARNING: THE EFFECTS AND DEVICES IN THIS BOOK ARE EXTREMELY DANGEROUS AND SHOULD BE UNDERTAKEN BY TRAINED PROFESSIONALS ONLY. THIS MATERIAL IS PRESENTED FOR INFORMATION PURPOSES ONLY.

SPARKS

In this trick, the magician produces a huge shower of sparks in his fist, which has to be seen to be believed. But it is dangerous, so you should understand exactly what you are getting into if you decide to include this in your act. You should not use this effect indoors without taking a lot of precautions. It's much too easy to ignite stage curtains or anything else in the area. You must wear an entire outfit made of flame-retardant cloth and wear heavy dark glasses; welder's goggles are best.

The illustration shows how to construct and perform the spark effect. You can walk around the stage doing other tricks while wearing the hidden

wiring under your clothes. Put the glove on and pick up the the ball of steel wool. Walk over to the metal plates on the stage and stand on them, thus completing the circuit. At once, sparks will be produced. Hold your well-protected arm as far away from your body as you can and crumple the ball. An instant shower of bright sparks appears.

CAUTION: You need to perform this effect deep back in the stage to prevent a spark from hitting someone in the audience. If you do this outdoors, beware of wind, which will carry the sparks. Use this with caution, folks; it's extremely dangerous.

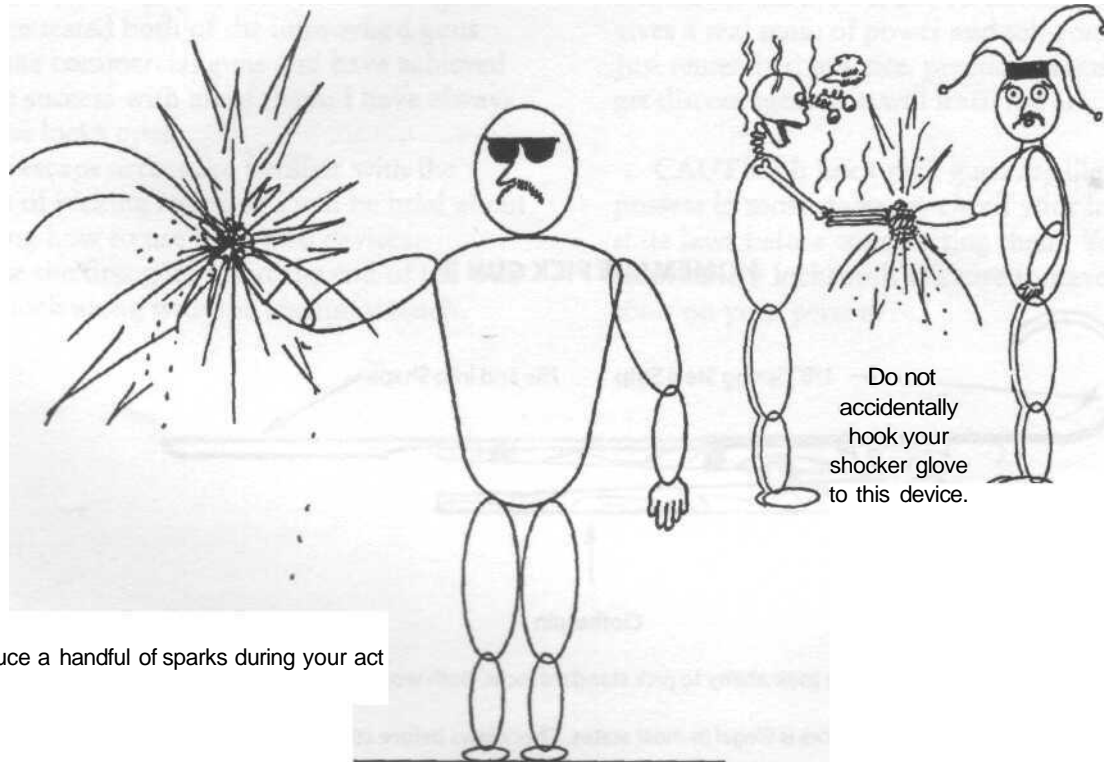

Produce a handful of sparks during your act

1. Magician stands on metal plates on floor, thus completing the circuit with the car battery.
2. By crumpling the ball of steel wool that will contact the metal plates on the glove, a huge amount of sparks is produced.

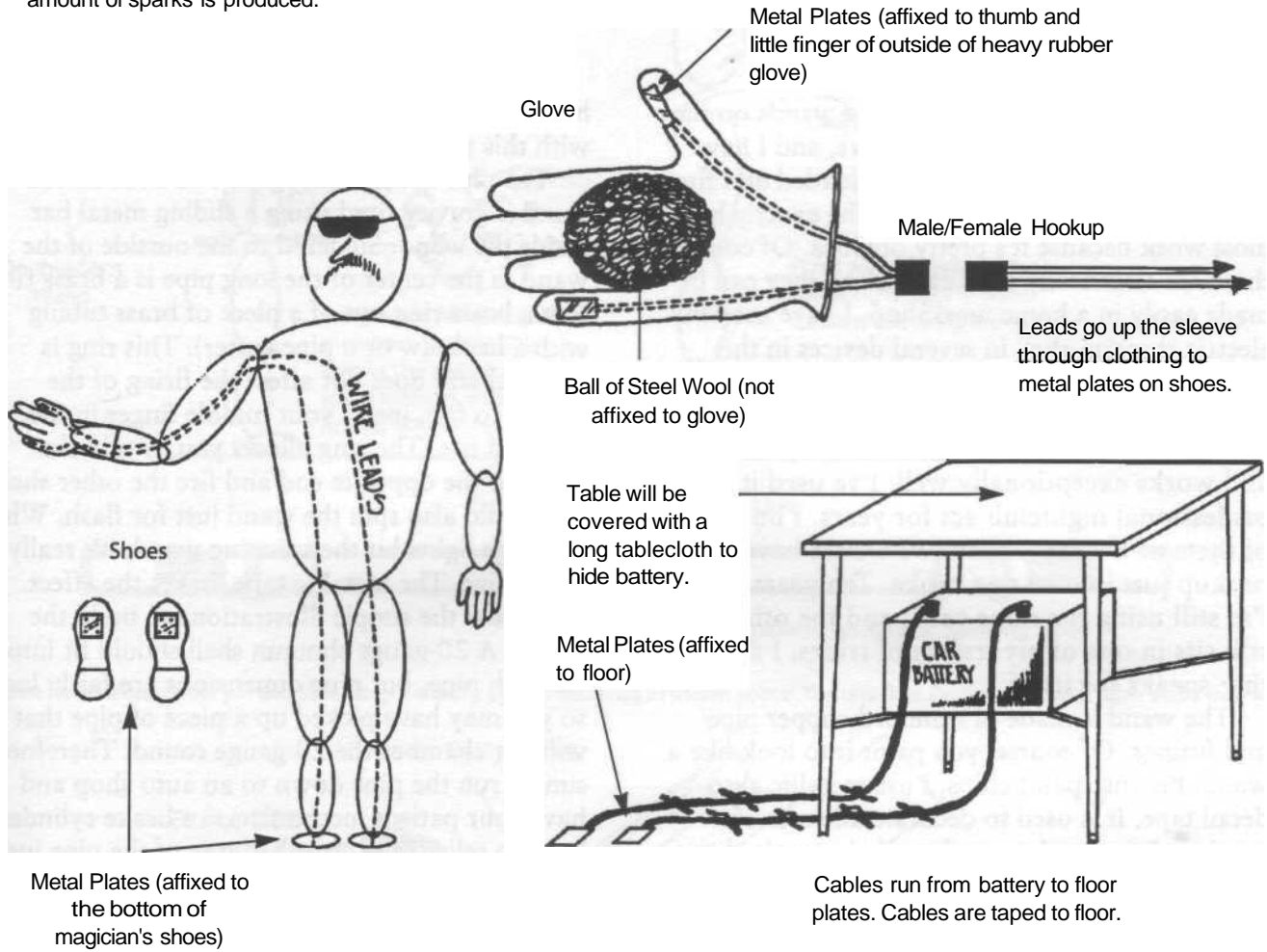

SHOOTING WAND, CANE, OR STAFF

There have been many shooting wands on the magic market over the last 40 years, and I have bought them all. Most are spring-loaded and fire basically like a gun. I won't describe exactly how most work because it's pretty obvious. Of course, there are electrically fired canes, and they can be made easily in a home workshop. I have used my electric shotgun shell in several devices in this book. Simply transfer that knowledge to a hollow steel cane and you're set.

The wand in the illustration is easy to build and works exceptionally well. I've used it in my professional nightclub act for years. I built two of them at the same time so I would have a backup just in case one broke. Ten years later I'm still using the same cane, and the other one still sits in one of my trunks of tricks. I think that speaks for itself.

The wand is made of standard copper pipe and fittings. Of course, you paint it to look like a wand. Because paint chips, I use metallic auto detail tape. It is used to decorate all sorts of magician's props that are for sale in magic shops. It adds huge dollars to the asking price for the trick, despite the tape's inexpensive price. Automotive stores carry all sorts of this stuff. It comes in rolls that are about 2 inches wide and around 10 feet long. This stuff really adds sparkle to a prop. Magic dealers don't really like my telling you where to get this stuff, but what the

hell. You can build professional props at home with this tape.

The pipe fittings fit together as shown. The wand is gravity fired using a sliding metal bar inside the wand. Soldered to the outside of the wand in the center of the long pipe is a brass ring (cut a brass ring out of a piece of brass tubing with a hacksaw or a pipe cutter). This ring is optional and does not affect the firing of the wand. To fire, insert your middle finger in the ring and fire. The ring allows you to spin the wand to the opposite end and fire the other shell. You could also spin the wand just for flash. When the stage lights hit the spinning wand, it's really impressive. The metallic tape makes the effect.

Follow the simple illustrations to build the device. A 20-gauge shotgun shell should fit into a 1/2-inch pipe, but pipe dimensions are fairly loose so you may have picked up a piece of pipe that will not chamber the 20-gauge round. Therefore, simply run the pipe down to an auto shop and have your patient mechanic use a brake cylinder hone to relieve the chamber area of the pipe just enough so the round will go in. It will take just a minute. You will also need to use a pipe-threading bottoming tap on the couplers. If you choose to use a 12-gauge shell, it will fit snugly into a 3/4-inch pipe.

If you're a pro, build this and try it in your act. It's great.

METHOD I

Unit is gravity fired.

Double-Shot Wand

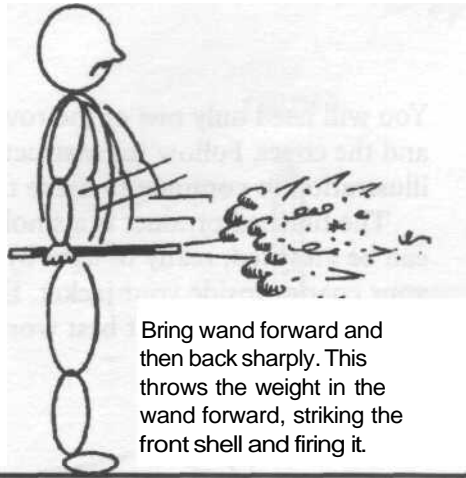

Bring wand forward and then back sharply. This throws the weight in the wand forward, striking the front shell and firing it.

METHOD II

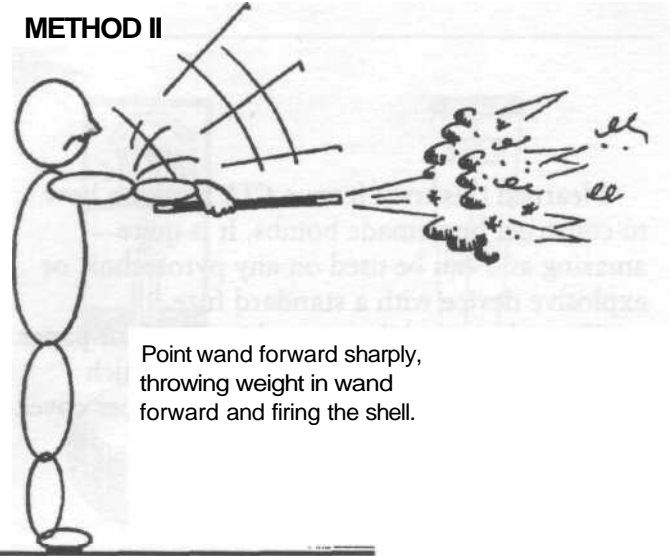

Point wand forward sharply, throwing weight in wand forward and firing the shell.

Cut-Away View of Assembled Unit

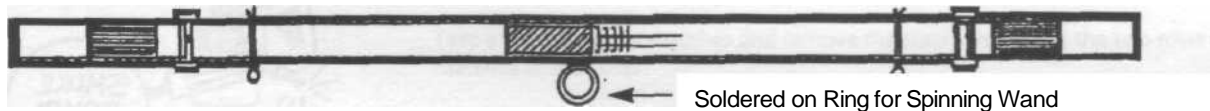

Soldered on Ring for Spinning Wand

To Use: Pull out one cotter pin and slide weight sharply against that shell as shown above. The unit fires. Do the same with other end if desired.

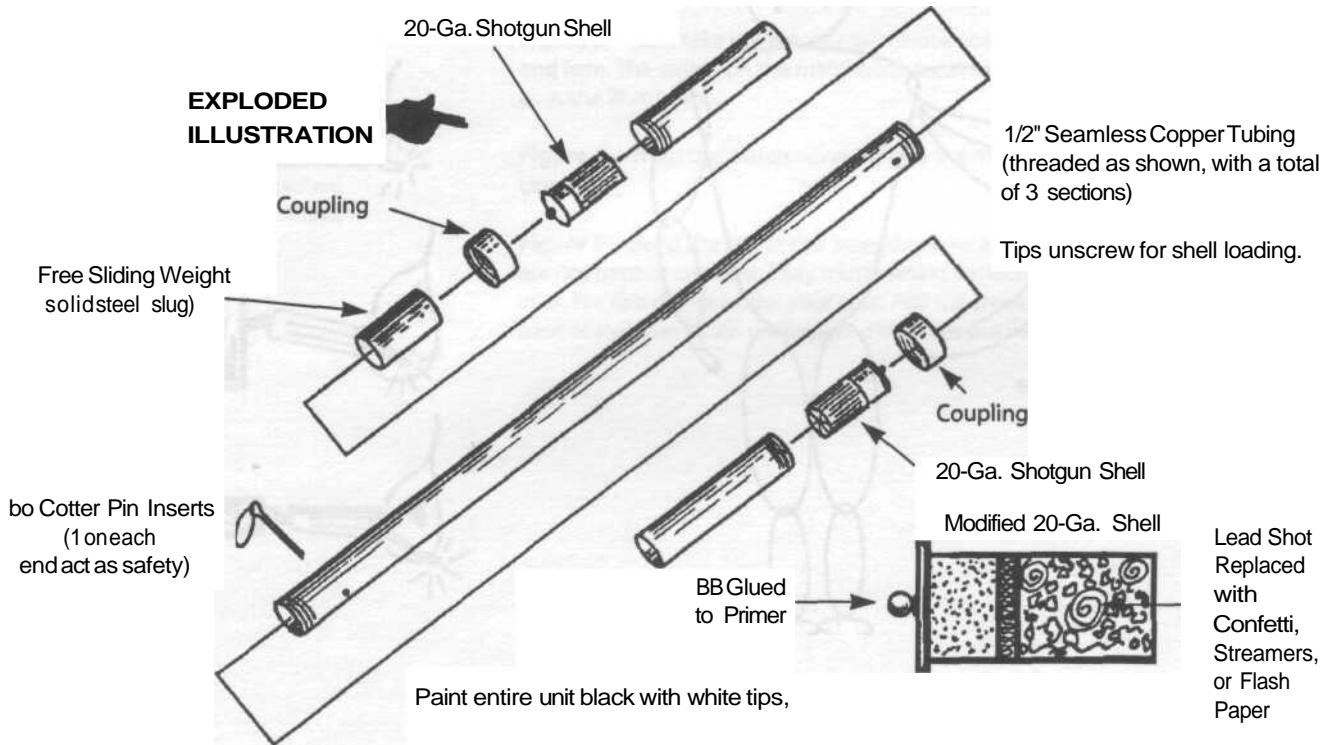

WARNING: THE EFFECTS AND DEVICES IN THIS BOOK ARE EXTREMELY DANGEROUS AND SHOULD BE UNDERTAKEN BY TRAINED PROFESSIONALS ONLY. THIS MATERIAL IS PRESENTED FOR INFORMATION PURPOSES ONLY.

SELF-LIGHTING FUZE PRINCIPLE

I learned this trick from a CIA book on how to construct homemade bombs. It is quite amazing and can be used on any pyrotechnic or explosive device with a standard fuze.

The only material you need is a book of paper matches. Start by removing the staple which holds the two rows of matches to the paper cover.

You will need only one of the rows of matches and the cover. Follow the instructions in the illustration to continue to make the device.

The finished product is a smoke bomb that can be attached, ready to light by itself, under your coat or inside your jacket. Experiment with this device to see how it best works for you.

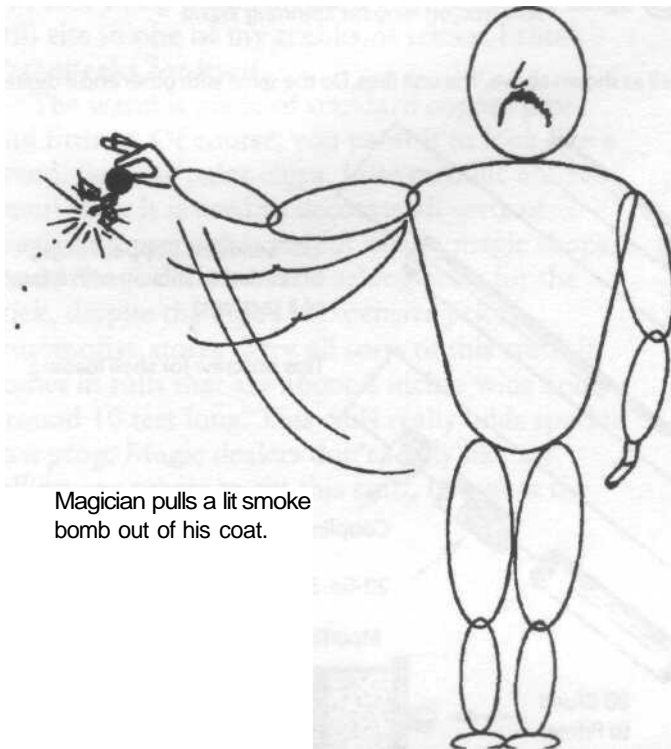

Magician pulls a lit smoke bomb out of his coat.

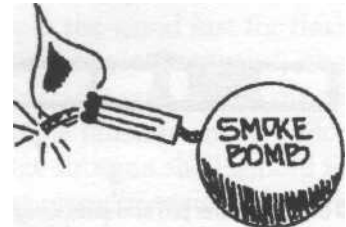

This device can be used to secretly light any fuze.

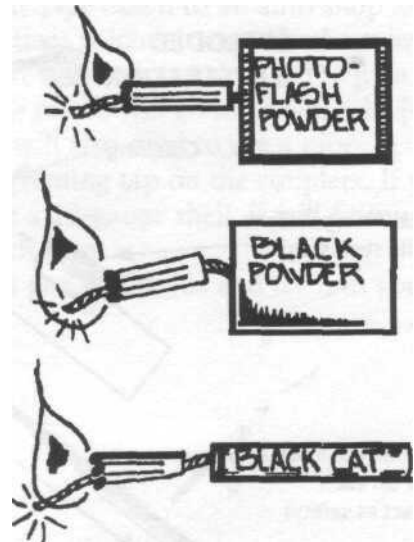

MATERIALS REQUIRED:

- 1 Book of Matches
- Tape
- Smoke Bomb

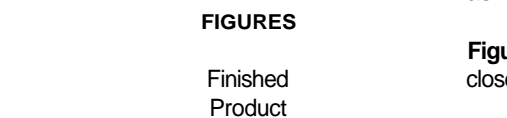
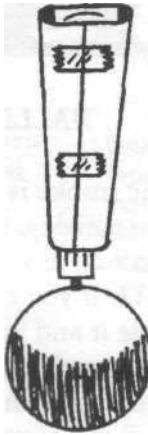
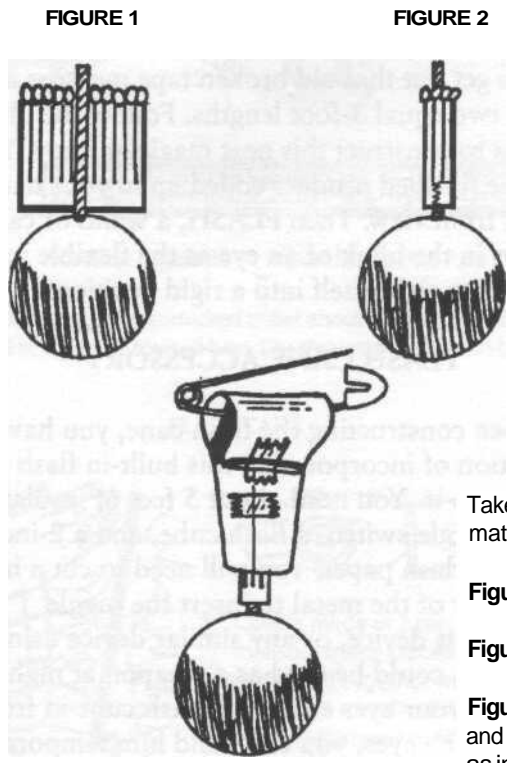

FIGURE 1

FIGURE 2

FIGURE 3

FIGURE 4

FIGURES

Finished Product

Take a book of paper matches and remove the staple that holds the two rows of matches to the cover.

Figure 1 — Place one of the rows of matches against the fuze of a smoke bomb.

Figure 2—Wrap the row of matches around the fuze and tape it closed.

Figure 3—Now take the empty matchbook cover and place it against the matches and fuze. The striker on the matchbook must be below the match heads, exactly as in the illustration.

Figure 4—Wrap the match cover around the matches fairly tightly and tape it closed.

Figure 5—Bend the top of this assembly over and tape it. Make sure the matches are not bent or crimped. They must remain perfectly straight inside the wrapped over. Pin this device under your coat. Pull the smoke bomb free from cover (hold base of matches when pulling), and it comes out lit.

MISCELLANEOUS WEAPONS AND EFFECTS

BALLISTIC SMOKES

Ballistic smoke is dangerous but could save your hide someday. It's basically a cigarette that fires a small-caliber bullet. You could either use a .22 or a .32. If you choose a .22, you will need to disassemble it and follow the instructions shown. Use a vice, goggles, and gloves. If you use a .32, you will need to remove the primer with an ice pick or nail. Thus you have an instant hole to insert the fuze and no drilling is required. Remember which way the bullet is pointing in the cigarette by marking one end with a pencil. Be careful.

ATOMIC SQUIRT GUN

This is easily constructed. Tape a butane lighter to the bottom of a squirt gun's barrel. Fill the squirt gun with lighter fluid or other highly flammable chemical. Use a rubber band to depress the butane button and keep it in place. I have shot flames up to 20 feet with a small squirt gun.

Anything that squirts water can be turned into a flamethrower using this method. Toy stores now have these megasquirt guns that fire a burst of water so hard you can put out someone's eye, and although I haven't tried, I'm sure one of these would make one hell of a flamethrower. Be the first guy on the block to turn these items into flame weapons and toys.

FLASH CANE

I have seen these on the market selling for well over twenty dollars in magic shops. They are

simple to make and cost only a few cents. You need to get out that old broken tape measure and cut off two equal 3-foot lengths. Follow the illustrations to construct this neat magician's toy. You hold the finished product coiled up in your hand, hidden from view. Then FLASH, a wand or cane appears in the blink of an eye as the flexible metal attempts to right itself into a rigid position.

FLASH CANE ACCESSORY

When constructing the flash cane, you have the option of incorporating this built-in flash device into it. You need about 5 feet of insulated wire, a toggle switch, a flash cube, and a 2-inch square of flash paper. You will need to cut a hole in one side of the metal to insert the toggle switch. This device, or any similar device using a flash cube, could be used as a weapon at night. If you close your eyes and fire a flash cube in front of someone's eyes, you can blind him temporarily while you make your escape.

INDUSTRIAL SQUIRT FLOWER

This is a heavy-duty squirt flower that I recommend you construct if you do the fire flower trick described on page 1. It is easily made from common materials.

CAUTION: Always wear goggles to protect your eyes and a heavy rubber glove on the firing hand. As with all fire tricks, keep no less than two fully charged fire extinguishers close by, and a swimming pool is even better.

BALLISTIC SMOKES

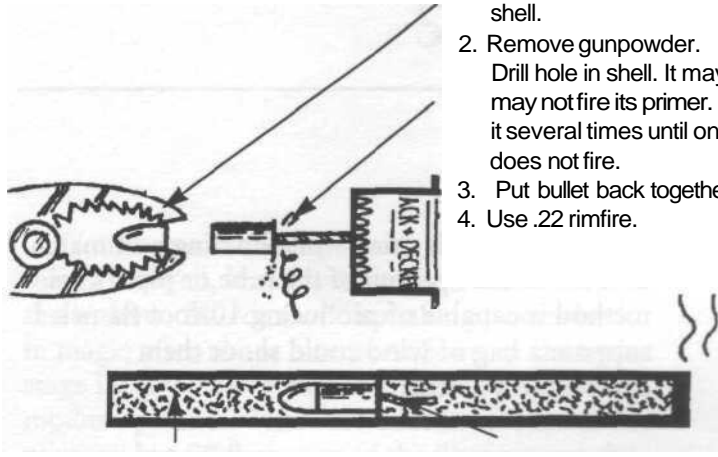

1. Pull lead slug out of a .22 shell.
2. Remove gunpowder. Drill hole in shell. It may or may not fire its primer. Do it several times until one does not fire.
3. Put bullet back together.
4. Use .22 rimfire.

Nonfilter Cigarette Insert firecracker fuze in hole in bullet.

Take tobacco out. Put gimmicked bullet about halfway. Put tobacco back in. Light end of cigarette toward fuze. Lay cigarette down with bullet pointing at target.

Squirt Gun Filled with Lighter Fluid

ATOMIC SQUIRT GUN
Mini Flamethrower

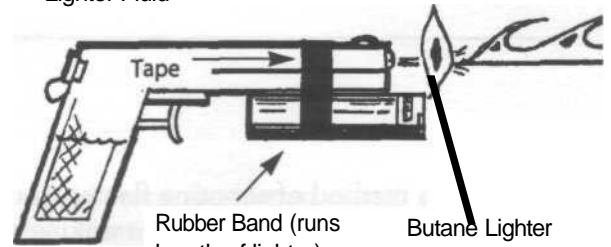

Rubber Band (runs length of lighter)

Butane Lighter Taped to Gun (butane release button held down with rubber band)

1. Snap rubber band lengthwise onto lighter so it holds down gas release.
2. Hold lighter so it points upward and light.

FLASH CANE

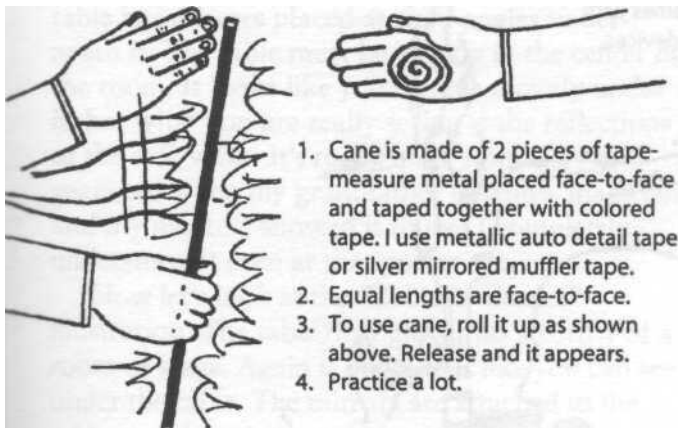

1. Cane is made of 2 pieces of tape-measure metal placed face-to-face and taped together with colored tape. I use metallic auto detail tape or silver mirrored muffler tape.
2. Equal lengths are face-to-face.
3. To use cane, roll it up as shown above. Release and it appears.
4. Practice a lot.

FLASH CANE ACCESSORY
Built-in Flash for Use with Above Cane

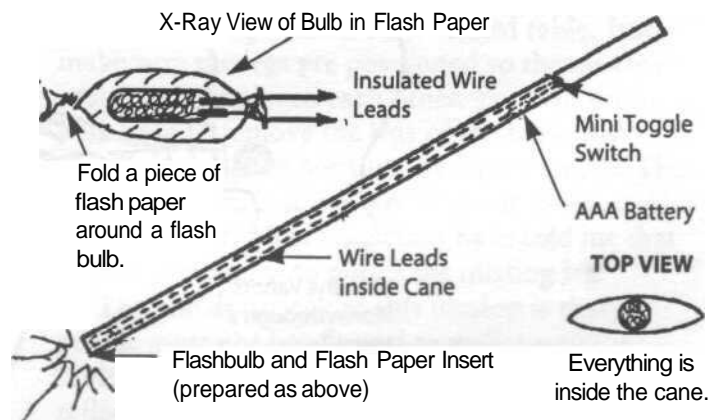

X-Ray View of Bulb in Flash Paper

Insulated Wire Leads

Fold a piece of flash paper around a flash bulb.

Mini Toggle Switch

AAA Battery

TOP VIEW

Everything is inside the cane.

INDUSTRIAL SQUIRT FLOWER

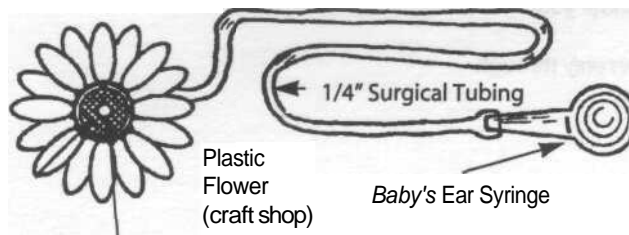

1. Attach safety pin behind flower. 2. Pin to lapel. 3. Secure 1/4" copper tubing, 1/2" in length to syringe with glue. 4. Punch hole in center of flower and insert copper tube. 5. Attach other end of surgical tube to this. 6. Can apply a reducer coupling to the end of flower, reducing it from 1/4 to 1/8". 7. To fire, see fire flower on page 1.

PSEUDOACID FLOWER—squirt oil onto hot surface or water into bucket of dry ice for an instant acid effect.

WARNING: THE EFFECTS AND DEVICES IN THIS BOOK ARE EXTREMELY DANGEROUS AND SHOULD BE UNDERTAKEN BY TRAINED PROFESSIONALS ONLY. THIS MATERIAL IS PRESENTED FOR INFORMATION PURPOSES ONLY.

GAS JET

This is a method of shooting flames from your mouth through a metal tube or a smoking pipe. You saturate a cotton ball with unleaded gasoline or kerosene and place it inside your mouth so it rests on the bottom of your mouth. You then insert the metal tube or pipe and blow vapors

through it. This is done while holding a lit match in front of the opening of the tube or pipe. This method is capable of producing 10-foot flames. I suppose a bag of wind could shoot them considerably farther.

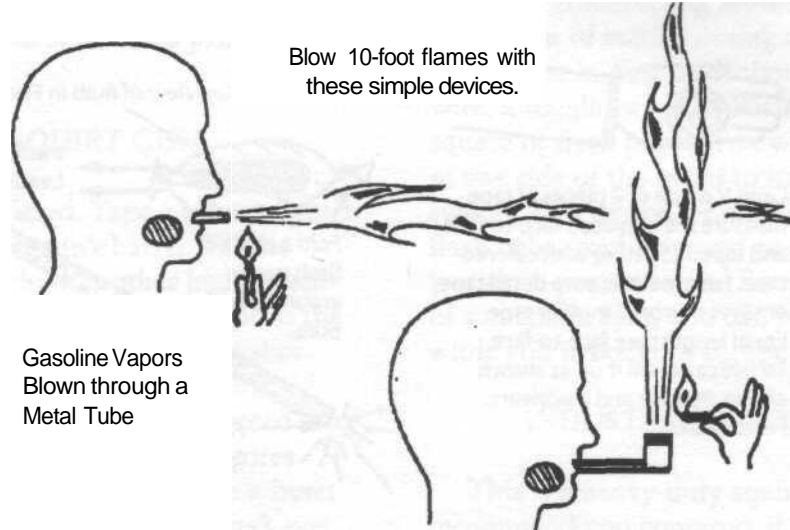

1. Hold a ball of cotton saturated with unleaded gasoline under your tongue.
2. Blow *vapors only* through tube or pipe.

SECRET HIDING PLACES

You've heard the expression "it's all done with mirrors." Well, here I will show you how it's really done. Mirror work is making a comeback in magic after about a century. Some of the major stage illusions use a mirror or mirrors as their modus operandi. There are dozens of ways to use mirrors, but 99.9 percent of the illusions use the basic principle I am about to demonstrate here.

I hope you understand what's happening in the illustration showing the tables. It's hard to explain how mirrors work when applied to the art of magic and stage illusions.

Look at the "Table in Room" illustration. The table has mirrors placed at right angles underneath it. The table must be exactly in the center of the room. It looks like you can see directly under it, but what you are really seeing is the reflections of the side walls. It's really quite simple. I was 5 years old when my grandfather (a fellow magician and my mentor) showed it to me. I completely understood it even at that young age.

Now let's look at the "Table in Corner" illustration. The table fits tightly into a corner of a room or stage. Again it only looks like you can see under the table. The mirrors are attached to the table exactly as in the previous illustration, but they reflect the walls differently. Each of the

mirrors is reflecting the section of wall directly in front of it. The table must be observed from this angle or close to this angle for the illusion to work.

Both of the above types of mirror work have been used in circus sideshows for centuries. Sometimes you will see a living human head resting on a plate on the table. In reality, there's a hole in the table and plate, and a guy is simply poking his head up through the table. The effect is quite uncanny.

Astute observers have no doubt observed that the back leg of the table is not there and wondered what to do about this. If you wish, you can place a leg in the proper position to be reflected, or you can simply use a three-legged table. Just make sure the legs are positioned so the mirrors are at right angles to each other. You will probably have to remove the legs of the table and redrill the holes to position the legs correctly. The last option—to just not worry about it—is probably best. Most magicians have told me that no one ever seems to notice the missing leg.

The one drawback to this illusion is that people must not be allowed to walk up to the table or they will see their own legs in the reflection. Obstacles are the answer.

IT'S ALL DONE WITH MIRRORS

Table in Room,
Audience View

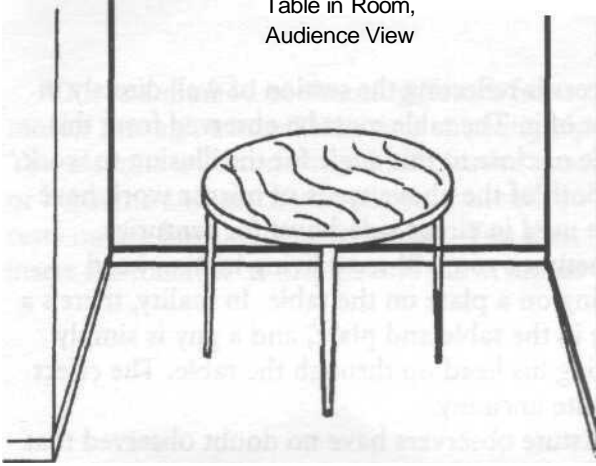
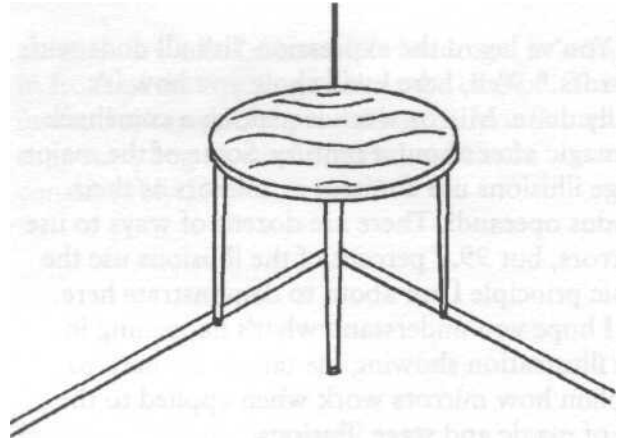
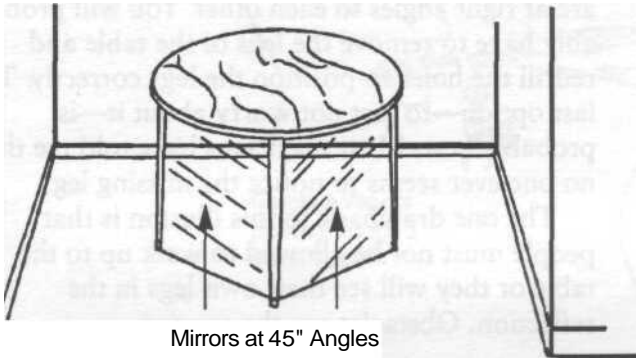

Table in Corner,
Audience View



It looks like you can see directly under these two tables. Actually, someone could be sitting under either table and be completely invisible. Both of these illusions use clever mirror principles.

HOW IT WORKS



Mirrors at 45° Angles

HOW IT WORKS

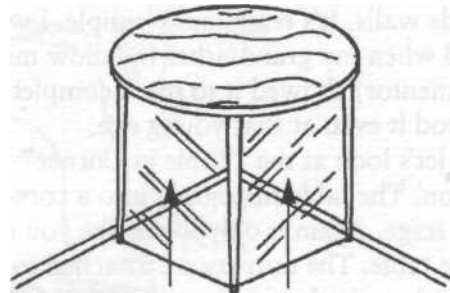

Mirrors at 45° Angles

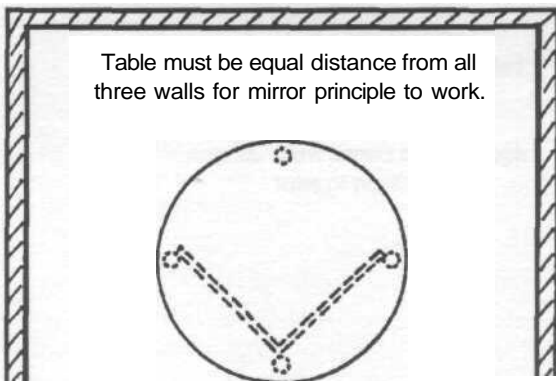
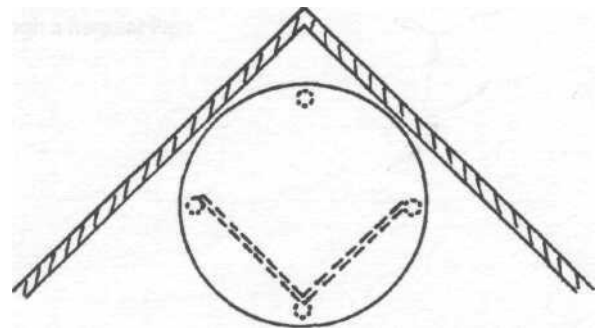

Table must be equal distance from all three walls for mirror principle to work.



BURGLAR DETERRENT I

I had to include these next two items just because they're so cool. That, and the fact that no one had ever bothered to document their use in the special effects field. OK, OK, so I saw this on "Wild Wild West." Good old Arty Gordon was always cooking up something for James West and his battle against evil midgets and such.

The illustration shows how this method works. I have just updated it to act as a burglar deterrent. A small electric train is set on a table

directly in front of a window in your house. A cardboard cutout of your upper body is attached to the far side of the toy train. A bright light is set up to cast the silhouette of the cutout onto the closed curtain. The train and the light are set up on a standard light timer found in any hardware store. The train is set on its slowest speed to avoid the absurd illusion of you running around the room.

The silhouette of a man is seen moving behind a closed curtain at night.

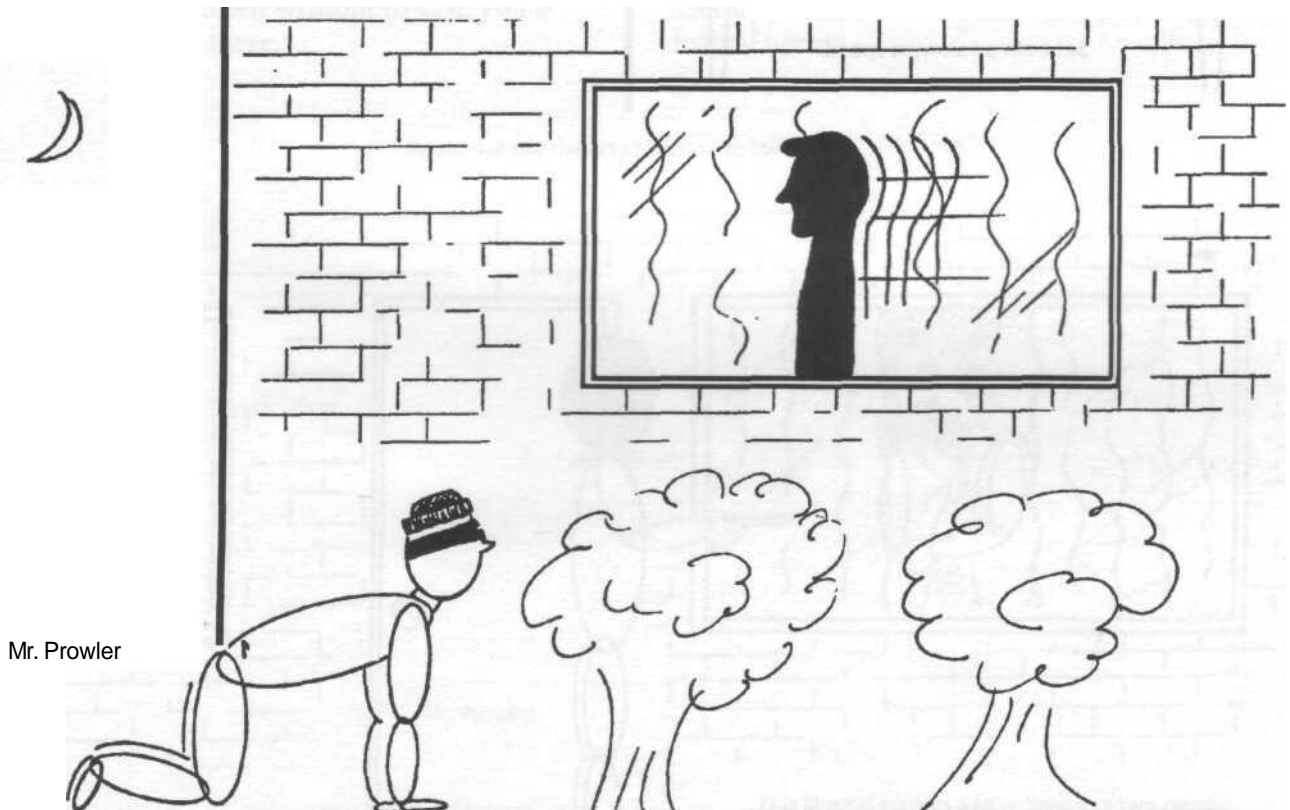

SETTING UP THE ILLUSION

Attach a cardboard cutout of a man on the side of an electric toy train.

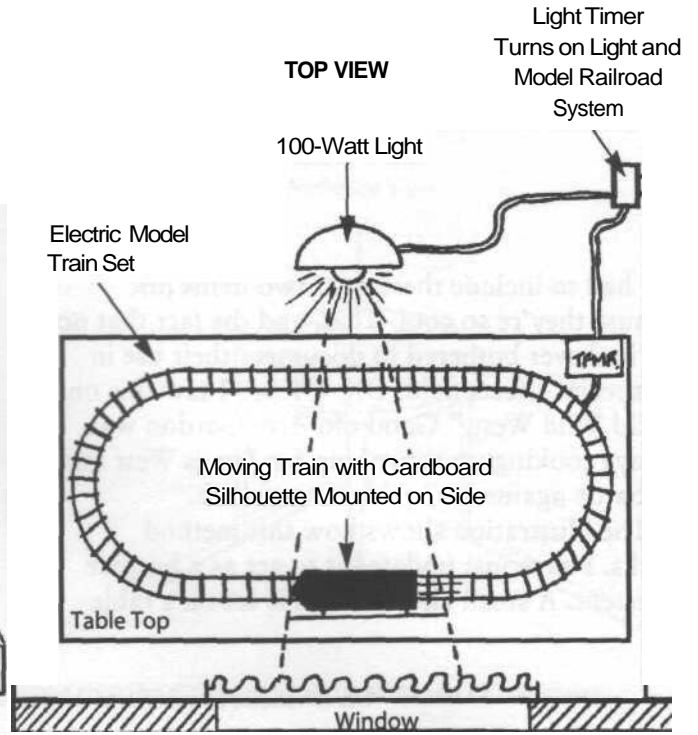
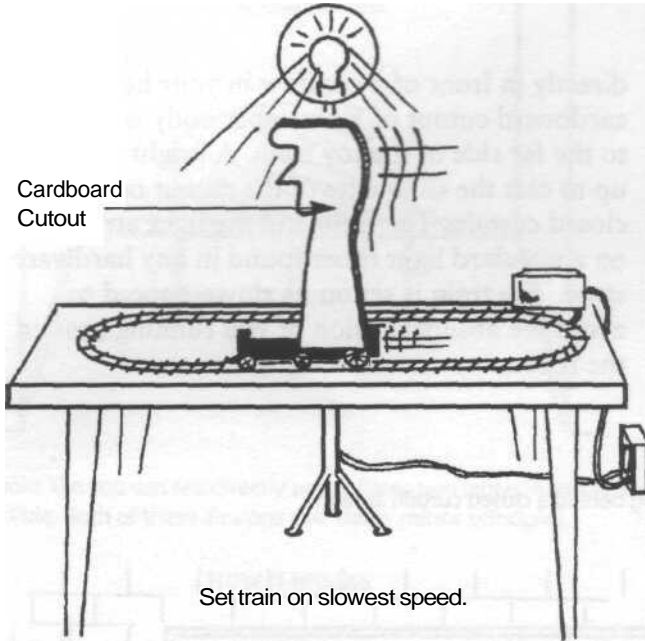

BURGLAR DETERRENT II

If you want to see this next method in use, rent the movie *F/X 2*. I know it looks silly as hell on paper, but it really works. Because of that movie, I know of two special effects technicians who have been contacted by an unnamed federal agency to help it fake murders. It's amazing how closely the art of deception in espionage parallels that of magic. Being a student of both arts, I can't overstate the fact that anyone who wants to get into the spying business should become at least an amateur magician. Study professional magic.

I know I get off on a tangent sometimes, but I really wish the book you are reading had been available 30 years ago. I'm just trying to impart some of my well-earned wisdom to save you a few years here and there.

Anyway, back on track. The illusion created here is that of a man and woman embracing in front of a window. Natural enough so far. As you can see our cartoon assassin is getting ready to interrupt this union with his trusty .45, but our couple has taken precautions to thwart this evildoer.

Method A uses film. Study the illustration and you'll see how it works. The assassin/prowler is really seeing only a film of the couple.

Method B uses the magician's friend, the mirror—in this case, a huge mirror. The assassin sees the reflection of the couple in the mirror and shoots at it. Having committed the crime, the "set-up" assassin is now rushed by a bevy of federal agents.

Again, we use the art of illusion to foil a crime.

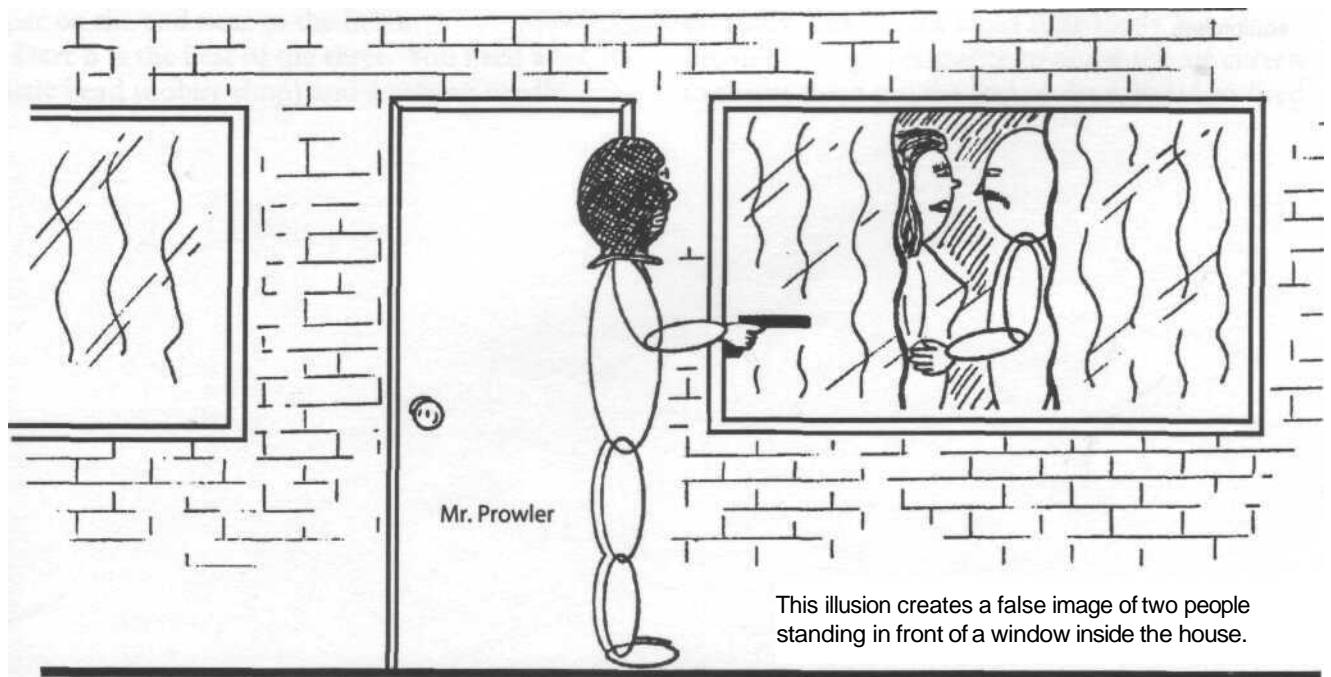

This illusion creates a false image of two people standing in front of a window inside the house.

METHOD A—FILM METHOD

1. Entire film was made in a room with lights off. Small lights illuminated people on film.
2. Room is dark. Curtains are only opened a little.
3. Film could be reel-to-reel, single loop, or more elaborate projection method.

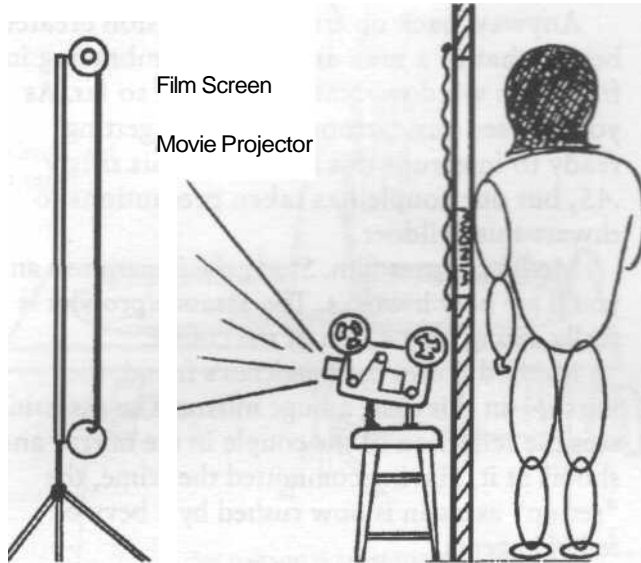

4. This method will work as shown above, but it works best if the viewer is at least 8 feet away.
5. You can use rear screen projection if you have access to the equipment.

METHOD B—MIRROR METHOD

1. Actual people must be present for this illusion to work.
2. The mirror is at a 45° angle to the line of sight. You could use regular glass or mylar, which has a reflective surface like a mirror but can be rolled up.

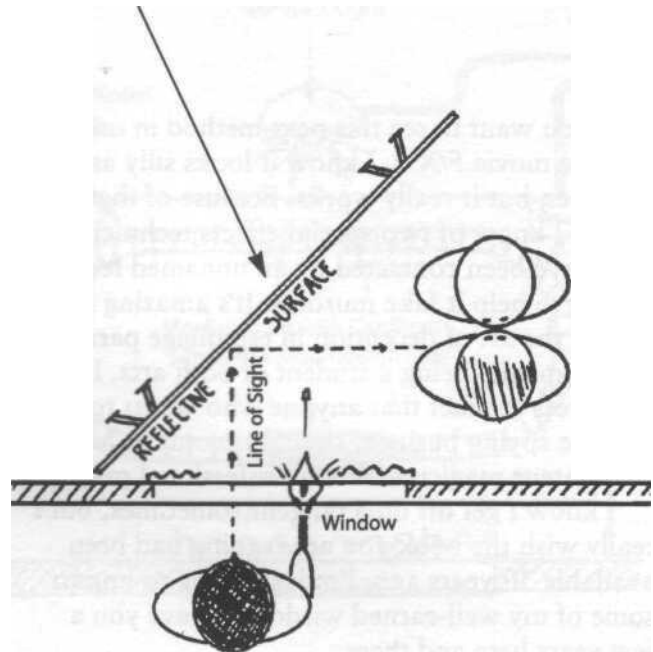

3. Sandbags can be set up behind mirror to stop bullet.
4. Prowler/assassin shoots reflection.

SLEEVE DARTS

Sleeve darts have no real use in magic, but this book is more or less a twisted treatise of the magician's art anyway.

To make this device you will need a 5-foot length of 1/4-inch surgical tubing (available at hardware stores, aquarium suppliers, or medical supply outlets), a 1-foot piece of copper or aluminum tubing with a 1/4-inch diameter, and a baby's ear syringe (any drugstore).

Attach the pieces together as shown. Place the rigid copper tube under your watchband or tape it to your inner forearm. Run the surgical tubing up your sleeve, across your back, and down the other sleeve into your palm. When you squeeze the bulb with one hand, the dart flies out the opposite sleeve.

There are various improvised darts you can make at home for this device. Three different types are illustrated.

Dart A is simply a push pin with a wad of paper on the end next to the head.

Dart B is the best of the three. You need a plastic bead (hobby shop) and a sewing needle.

Hold the needle with a pair of pliers and heat the blunt end until it's red hot. Then push this hot end into the plastic bead. Hold it in place until it cools, usually only a few seconds. That's it.

Dart C is made from a wooden match. Cut the head off the match with a razor blade. Then take a sewing needle (or cut the head off a push pin) and, using a pair of pliers, push it into one end of the wooden match. To attach the fin, slice the opposite end of the match about 1/2 inch from the top. Pry this slit apart with your fingers and insert the fin (which, by the way, is a single piece of paper folded as shown).

I have had great success with all the above darts. To fire a dart, you insert any one of the above into the mouth of the rigid copper tube and push it all the way back to where the surgical tubing and the rigid tube connect. The dart with the bead works best because it falls right into place. Both of the other darts have to be inserted carefully. The darts should slide freely but yet provide enough resistance to allow the air current to thrust them out the end of the tube when fired.

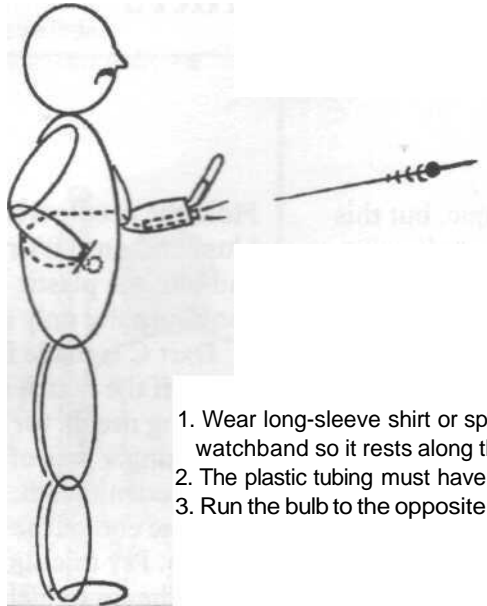

1. Wear long-sleeve shirt or sport coat and insert copper tube under watchband so it rests along the forearm.
2. The plastic tubing must have no kinks.
3. Run the bulb to the opposite pocket.

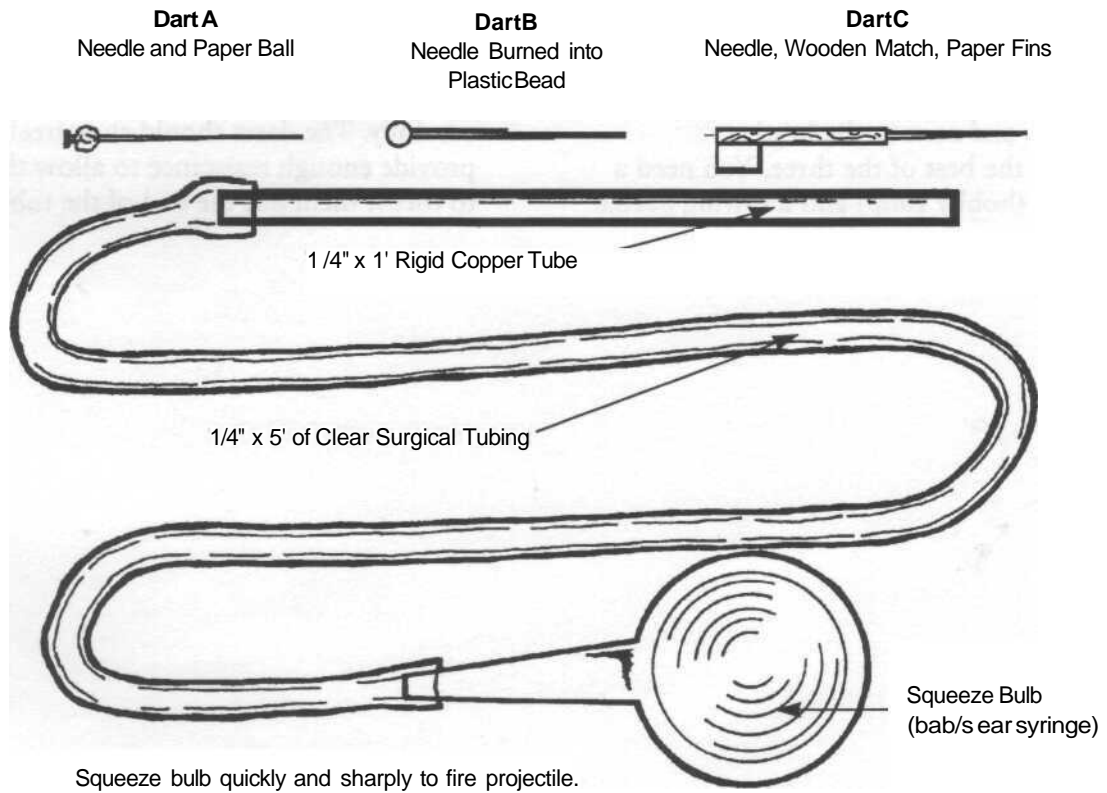

UNBELIEVABLE

So you want some of the really good stuff, do you? Well, friend, you've got it. This is hard-core magic. You usually have to be in magic for years before you run across these extremely closely guarded secrets.

SMOKE FROM THE MOUTH

I don't know if you have ever seen this effect performed or not. I first saw Stan Laurel perform this in an old Laurel and Hardy movie, the title of which slips my mind. Anyway, the magician pretends to smoke his thumb. You see him taking drags off his thumb and blowing out smoke. It's the strangest thing you've ever seen.

The illustration shows how to construct the device that makes the trick work. It's a 1-inch wooden dowel (wooden because metal heats up too quickly and burns your mouth), drilled as shown. You can actually do the trick without using the device if you're good. You simply hold the cigarette reversed in your mouth as with the device, except without it. This is for guys who really want to do the trick for a living. I

recommend using the device, since it's much safer.

Many pros use this same device or one similar. The other type of gimmick used for this trick uses a smaller dowel, about 1/2-inch. With it, you simply bore a 1/4-inch hole through it, and that's it. The cigarette is stuffed in the hole and lit. Some of my fellow professionals prefer this gimmick over others. I'm always worried about the cigarette going out at the wrong time, but it's up to you. Build them both and see which you prefer.

There are also hand-held models of this trick. The best is a wooden egg-shaped shell with the front end open. On the other end is a small hole with a small tube glued over it on the outside. The cigarette is inserted in the shell and on into the little hole and tube. You stick the little tube end into your mouth and light the cigarette in the shell. Take long heavy drags to suck the flame into the shell and light the cigarette. In performance, you pretend to smoke your thumb while actually taking puffs of the gimmick. I much prefer the "in the mouth" gimmick. These devices are for sale in magic catalogs.

SMOKE FROM MOUTH

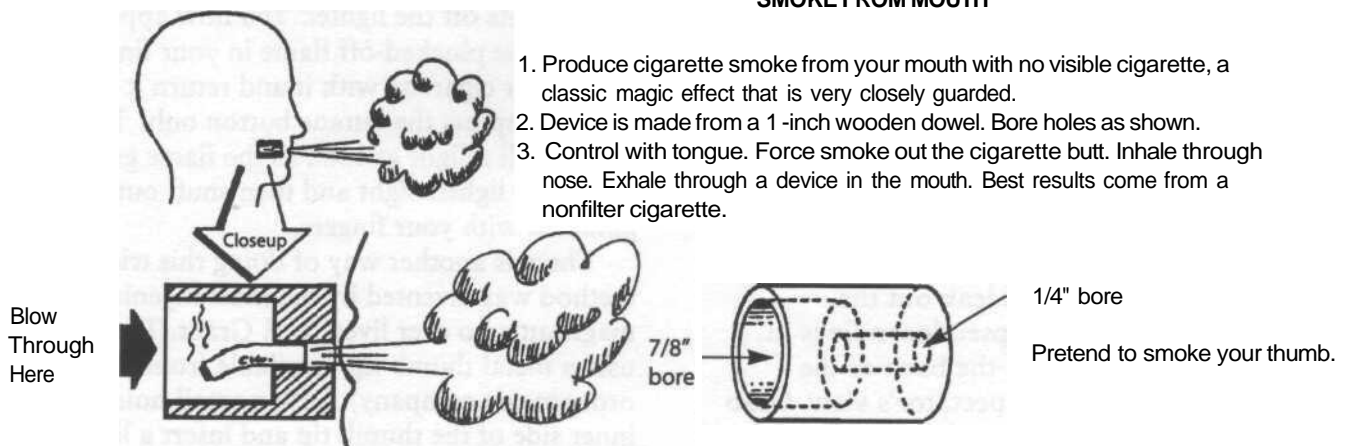

FLAME-LIFTING METHODS

Imagine, if you will, going into a restaurant or your favorite hangout, putting a cigarette in your mouth, reaching over to a candle and pulling off the flame, and then lighting your cigarette with it. That's just one of the things you can do with this trick/effect.

Method A uses an easily constructed device that can be carried around with you or used with the candle as shown in the illustration. It is simply a 1/2-inch piece of copper or metal tubing that has been crimped in one end and has a small piece of a birthday candle inserted in its open end. When used with the large candle, this apparatus is attached to the candle as shown. The illustration shows a side view of the candle. The audience will see the candle from the front, and no trace of the gimmick will be visible.

If you want to use the gimmick by itself, simply hold it as shown between two fingers, hidden from the spectators. Reach over to an open flame, such as a candle on the table, and let the candle light the gimmick. Then light your cigarette. While it will not appear as if you pulled "the flame" off the candle, it will look as if you pulled "a flame" off it. And a miracle will have still been performed.

Method B is more mechanical. Paint a 1-inch wooden dowel white to resemble a candle and drill a hole about 1-inch deep in the top of the candle. Stuff a piece of copper tubing, which is also painted white and has a piece of wire soldered to one side of it, with cotton and insert a lighter wick in the top of it. Saturate the cotton and wick with a little lighter fluid (not a lot or the fluid will leak out the bottom—not good). The pseudocandle is lit. The wire is, of course, on the back of the candle, hidden from the spectator's view. Grab the wire between the first and second fingers (same grip as in the previous method) and

swivel the hand around so the audience can't see as you lift the tube out of its holder. The audience should be seeing the back of your fingers and hand and a flame floating above your first finger. Light your cigarette, replace the flame into the candle, and take a bow.

Method C basically uses a special set of tweezers made out of fine (thin) music wire. This device is held in the fork between your thumb and first finger. In magic we call this the "downs palm." A coin held in this position is invisible when viewed from the front or back, as is the gimmick used in this trick (see illustration of audience view). You are simply holding a birthday candle stub or lighter wick between the prongs. This candle stub can rest on top of a larger candle, or you can have a lighter wick, saturated with lighter fluid, tied to the two prongs and pretend to pluck a flame off a candle or lighter. Pulling a flame off a butane lighter looks very impressive. You light the lighter and hold it with one hand, while in the other hand you secretly hold the gimmick. With the lighter lit and held in front of you, reach up with the gimmick hand and light the wick on the prongs. When it's lit, you release the butane button, which shuts off the lighter. You now appear to be holding the plucked-off flame in your fingers. Light your cigarette with it and return it to the lighter. Depress the butane button only. The lighter will relight as soon as the flame gets near it. Let the lighter light and then snuff out the gimmick with your fingers.

There is another way of doing this trick. This method was invented by the most ingenious magician who ever lived, U.F. Grant. The trick uses a metal thumb tip (available from any mail order magic company). Drill a small hole in the inner side of the thumb tip and insert a lighter wick. A couple of balls of cotton are shoved in

the thumb tip and saturated with a little lighter fluid. To use, slip the thumb tip over either thumb. Then reach over to any open flame and

light the wick. This trick can be bought, ready to use with instructions, for an absurdly low price. The effect, however, is priceless.

FLAME LIFTING

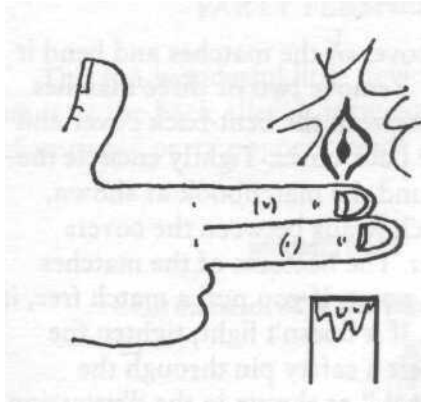

METHOD B

1. Performer lifts the flame off a candle with his bare fingers!
2. He then lights his cigarette or another candle.

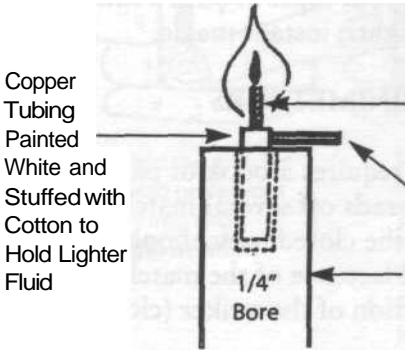

Copper Tubing Painted White and Stuffed with Cotton to Hold Lighter Fluid

Lighter Wick Presoaked with Lighter Fluid
 Handle Soldered On (lift with fingers as above)
 Fake Candle (wooden dowel painted white)

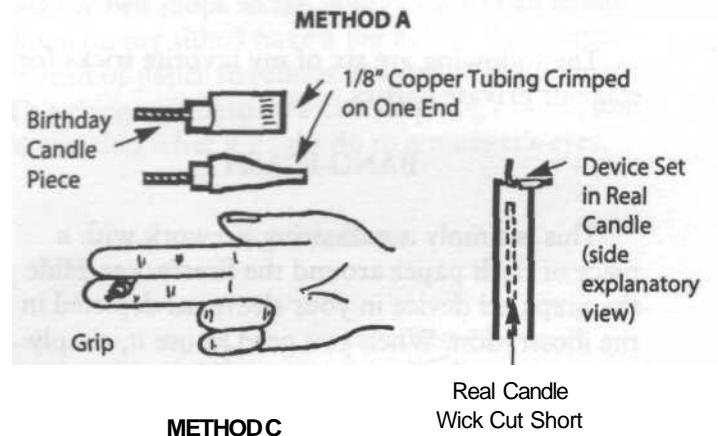

METHOD C

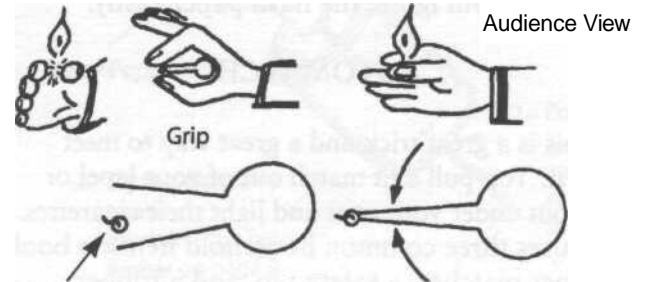

Real Candle Wick Cut Short
 Grip
 Audience View
 Birthday Candle Stub Set On Top of Big Candle

Gimmick (made of thin music wire)

SELECTED FLAMES AND FIRES

The following are six of my favorite tricks for stage or private parties.

BANG-FLASH

This is simply a pull-string firework with a piece of flash paper around the firecracker. Hide the prepared device in your sleeve, as depicted in the illustration. When you need to use it, simply insert your right thumb into the free loop and pull. A bright flash will appear in front of your chest, along with the firecracker bang. The firecracker will ignite the flash paper easily.

AUTOMATCH

This is a great trick and a great way to meet women. You pull a lit match out of your lapel or out from under your coat and light their cigarettes.

It uses three common household items: a book of paper matches, a safety pin, and a rubber

band. Open the cover of the matches and bend it all the way back. Remove two or three matches and place them between the bent-back cover and the striker on the back cover. Tightly encircle the rubber band around the matchbook as shown, trapping the match heads between the covers against the striker. The bottoms of the matches protrude. At this point, if you pull a match free, it will come out lit. If it doesn't light, tighten the rubber band. Insert a safety pin through the matchbook "tunnel," as shown in the illustration, and pin this under your lapel or your coat. Pull a match free and it lights: instant magic.

MINIMETEORS

This trick only requires a book of paper matches. Cut the heads off several matches with a razor blade. Hold the closed matchbook in your fingers as shown. Place one of the match heads on the bottom portion of the striker (closest to

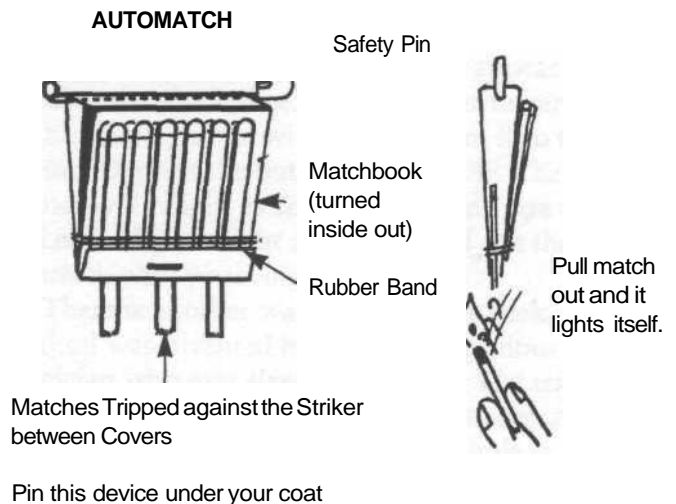
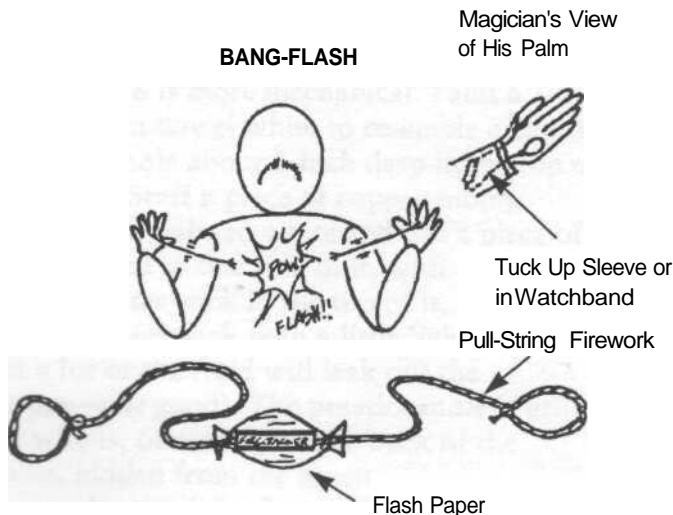

your body) and place the thumb of that same hand on the match head to pinch it between the striker and thumb. Thrust that thumb forward quickly and release the match head. It will light and shoot forward (or any direction you wish).

PARTY FLASHER

This is a wonderful little device for either the stage or the back alley. It is one of those little champagne party poppers inside a metal 35mm

film can. If you don't want to buy a roll of film, the grocery store has many products in metal cans (spices, etc.) Poke a hole in the bottom of the can and insert the string from the party popper through it. That's it; you're ready to perform. I keep one of these, ready to use, tied to one my belt loops so the popper in the can hangs down on my side. I have a big ball of flash paper instead of paper streamers inserted in the popper. This thing will destroy a charging dog's mind, not to mention what it might do to a mugger's eyes.

MINIMETEORS

1. Cut the heads off several paper matches.

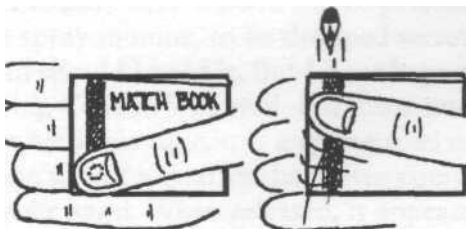

2. Hold the match head under your thumb and against striker.
3. Scrape the match head across the striker as your thumb throws it forward quickly.
4. Flip the lit match several feet

PARTY FLASHER

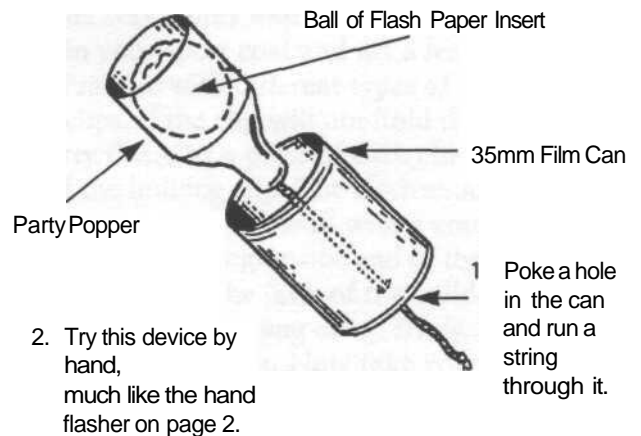

2. Try this device by hand, much like the hand flasher on page 2.

FLAMING FINGER

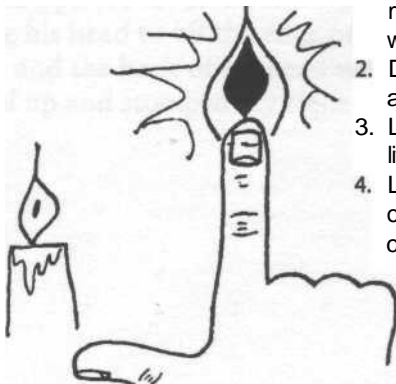

1. Stick your finger in your mouth and wet it heavily with saliva.
2. Dip finger in rubbing alcohol.
3. Light finger with match or lit candle.
4. Light cigarette with finger or transfer flame from candle to candle.

FLAMING FINGER II

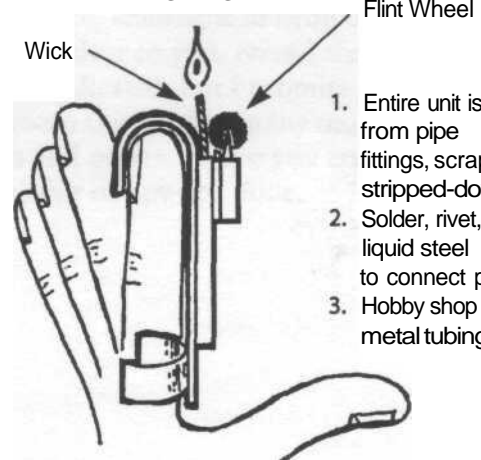

1. Entire unit is made from pipe fittings, scrap metal, and a stripped-down lighter.
2. Solder, rivet, or use liquid steel to connect parts.
3. Hobby shop has small metal tubing and fittings.

FLAMING FINGER I

This is great for lighting someone's cigarette or transferring a flame from one candle to another. Stick your finger in your mouth to wet it. Then dip the finger in rubbing alcohol (or, if in a bar, use 151 rum). Light your finger immediately with a lighter or any open flame. Blowout when done. Don't let it burn for more than 3 or 4 seconds, or the fire will extinguish on its own.

FLAMING FINGER II

This mechanical device does the same thing as in the previous example except that you can let your finger burn for as long as you want. This device is painted flesh tone and is invisible from a few feet. It is made entirely from small metal pipe fittings. This device was on the market years ago, and I still see one now and then. It's much easier just to build your own. Enjoy.

UTILITY DEVICE

Of all the magician's utility devices I've ever bought (and I have bought hundreds through the years), this one is absolutely the best. Take my word as a professional inventor of magicians' illusions and devices, this is the best utility device in the world, with uses on and off the stage.

I keep one pinned to the side of the waistband of my pants. You can keep whatever you want inside. I usually keep a small can of personal defense spray in mine, to be dropped secretly into my hand should I need it. But I have kept a Walsh Appearing Cane in it as well. For those unfamiliar with this cane, it is a spring steel cane about the size of a quarter that when compressed fits in your hand. When released, it appears so fast the eye cannot follow where it comes from. Anyway, I had one of these in this utility clip we are now discussing when this huge bouncer in a bar was giving me a rash of crap. He knew my hands were empty (all bouncers and cops watch hands very closely). I pressed the clip and silently dropped the closed cane into my hand. I raised my hand slightly and released the catch on the cane. The cane sprung open so fast even I didn't see it. I popped that son-of-a-bitch right in the left eye. He screamed bloody murder and cupped his eye. I reached down, grabbed hold of his pant cuffs, and pulled his feet out from under him, causing his head to hit the edge of the bar. Now his eye and the back of his head were bleeding. I jumped up and stomped my right heel into his

gonads on the way down and promptly did my disappearing act. That's only one instance of this utility device saving my hide.

This utility device is easy to construct. Simply solder or tape a safety pin to the top of an office type bulldog clip. Attach this to the side of your belt or the waistband of your pants, as in the illustration. Or you can rivet a bulldog clip to your belt; either way works well.

Put on your sport coat and get a feel for the device. Practice with different types of loads and sizes of clips. If the clip will not hold the load of choice, try this. Get a piece of dark cloth the width of the bulldog clip. The cloth should be able to wrap around the load with a couple of inches to spare. Now glue one end of the cloth to the inside of one of the jaws of the bulldog clip. The other end should hang down freely. When the glue dries, you're set. Now take your load and set it in the center of the cloth. Take the free end of the cloth and loop it around the load and clip the free end in the jaws of the clip. Hold the bulldog clip up by the safety pin. The load should be hanging in the cloth under the clip. Now when you squeeze the clip as usual, the cloth should release the load, causing it to drop out freely. If this seems unclear to you, reread the description. It's a bit complicated, but I promise it's worth it.

I have seen this used in many movies with magicians and others. I hope you enjoy having the knowledge of how it's done.



Bulldog Clip (with a safety pin soldered on)

(Magician is shown without coat for clarity)

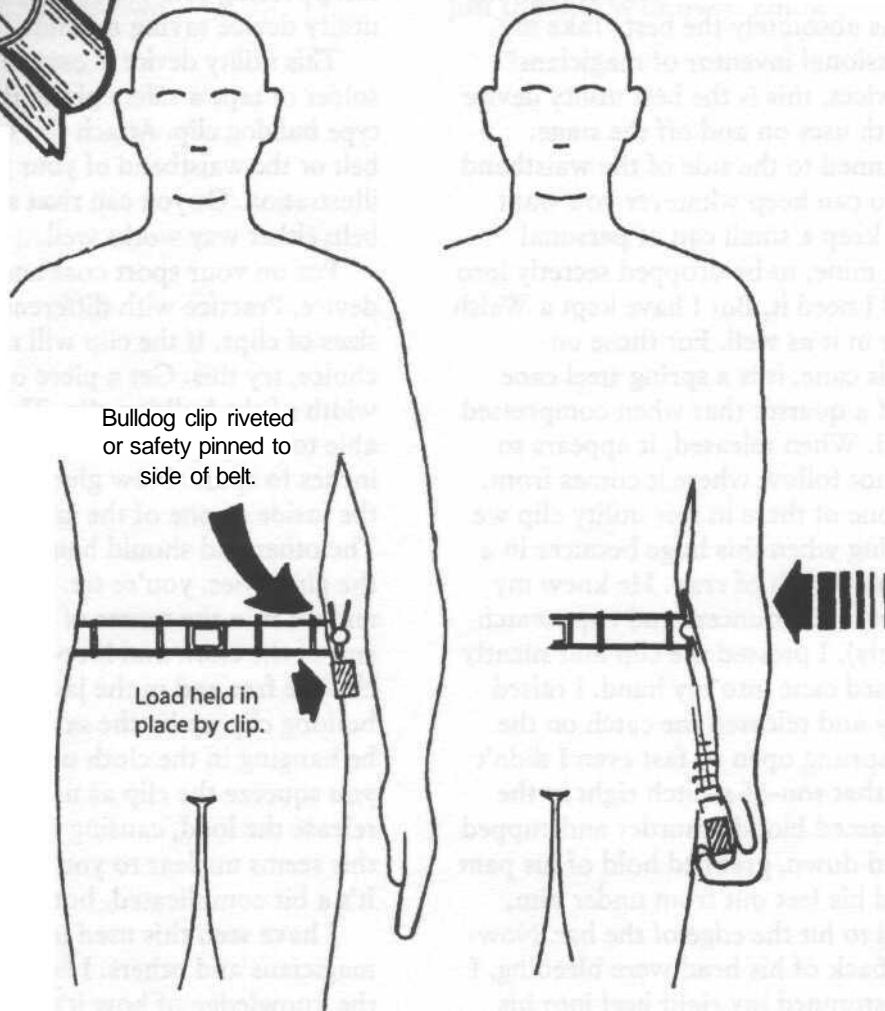

1. Push inner forearm against bulldog clip.
2. Clip opens and load is released.
3. Clip fingers and catch load as it falls from beneath your coat.

4. Your local office supply store can provide you with a multitude of different kinds of bulldog clips.
5. You might attach several of these clips to your belt, thus creating a magician's utility belt.
6. This device can deliver a wide range of objects secretly and silently to your hand.

FIRECRACKER DEVICES

CAUTION: The following are extremely dangerous devices and are not toys. These are minibombs *for professional use only*. Do not show children how they are made or allow them to view any portion of this.

EXPLODING DARTS

This is a large firecracker with a sewing needle shoved in one end. On the other end is a wooden match with its head cut off. The match is split about 1/2 inch from one end and a piece of paper inserted. This paper is fashioned into a guiding fin. Light the device and throw it at the bad guy.

EXPLODING EVASION DEVICES

You're probably wondering what kind of twisted person came up with this. I did. I can't help the fact that I'm a creative person. Designing

infernal machines and devices is a hobby of mine, in case you haven't noticed. This device is nothing more than a firecracker with fishhooks attached to it with tape or glue. The device is lit and thrown onto the evildoer's clothes. Think about that for a second. It's raw terror. The device sticks to him, and he can't get it off. When it blows, the fishhook shrapnel embeds in his skin. Use only in a life-or-death situation for obvious reasons.

EXPLODING CIGARETTES

This is a firecracker that has been inserted into a cigarette. I thought of inserting a nonelectric blasting cap, but even I thought that was a little too far. Cut the fuze on the firecracker short. The tobacco provides a delay, but make several and experiment so you can find out exactly how long a delay. These are great for diversion. Enjoy.

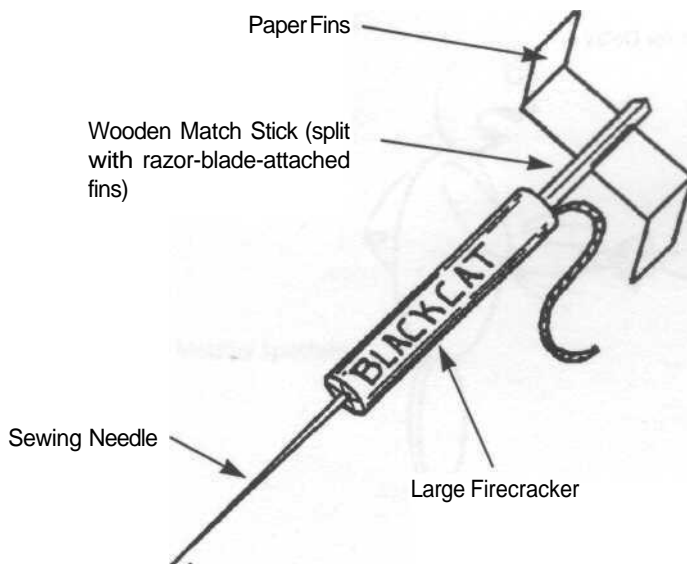

EXPLODING DARTS

1. To be thrown outright or blown through a blowgun.
2. You could glue or tape "strike anywhere" match heads to the end of the fuze.
3. Light on the wall or sidewalk or throw to ignite.
4. Needle becomes shrapnel when firecracker explodes.

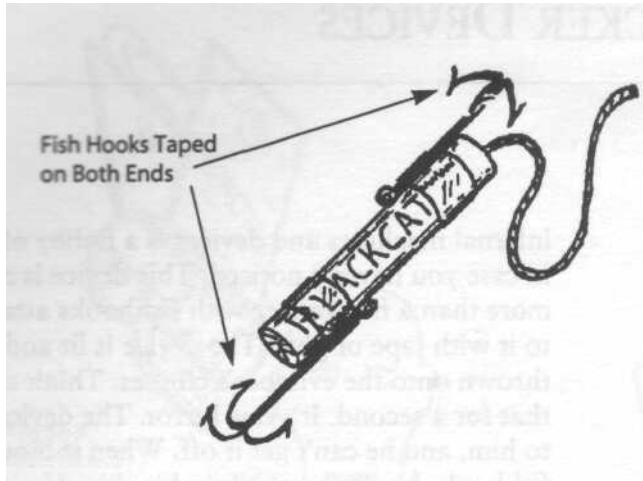

EXPLODING EVASION DEVICES

1. Light and throw. Run like hell!
2. This extremely dangerous device will stick to clothing of attacker when thrown and won't come off until it explodes.
3. Glue or tape on BBs for added shrapnel.

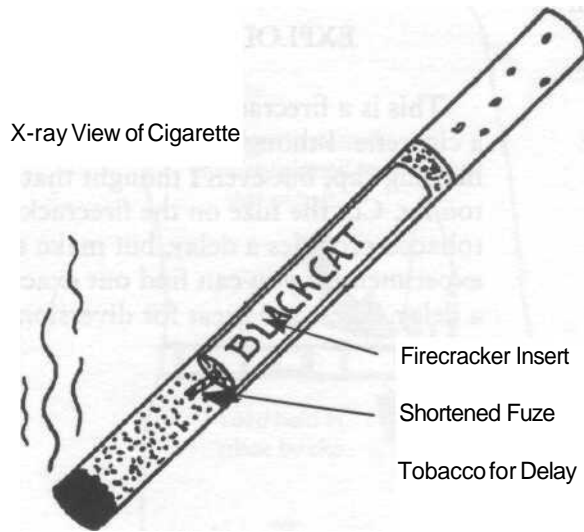

EXPLODING CIGARETTES

1. This method could also be used for industrial-strength exploding cigars.
2. These cigarettes are not to be smoked!
3. Drop several of these around a room via a magician's cigarette dropper, which holds about 10 lit cigarettes. (See magic dealers in Appendix E to mail order a dropper.)

PICK-A-CARD

This is a nasty little joke that might get your butt kicked if you pull it on the wrong person. Be prepared with a backup if it goes awry. I use it on loud-mouthed drunks. Of course, I weigh 255 and am built like a football player. This is not something for the pencil-necked geek-type magician. If you look anything like our beloved ex-president, George Bush, with a shirt collar size of 12, pass on this one. You'll just get stomped. Don't get mad at me. I absolutely love to jump into a fight where some little guy is getting his butt kicked and rescue him. Let's stay friends.

You need to start by removing everything from a mousetrap except the fly bar (the part that flies over and snuffs the mouse). Do this with a pair of needle-nose pliers. That's all there is to it.

Bend the fly bar back on the mousetrap and

hold it down, under tension, and invert it. Pinch the bar against the wooden base with your first finger and thumb and hold it like that. Now put a deck of cards on top of the bottom part of the mousetrap (bottom is facing up) and fan the deck. Pinch the rest of the mousetrap closest to your body (there will only be about 1/8 inch) with the rest of your fingers. Also pinch in this grip from above with the thumb.

Ask some idiot from the audience to pick a card. Justify your actions by picking a heckler, never a woman or child! The sucker reaches over to pick a card, and his fingers go beneath the deck. At that instant, release the fly bar. Tell him that's a souvenir he can take home to cherish this magical moment for eternity. Laugh your fool head off as you say this.

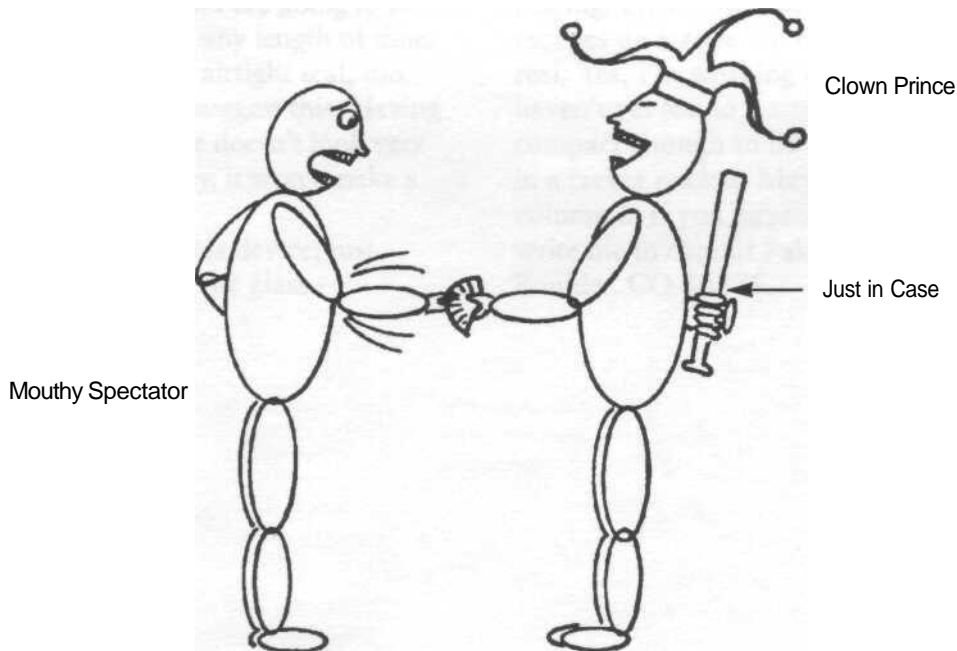

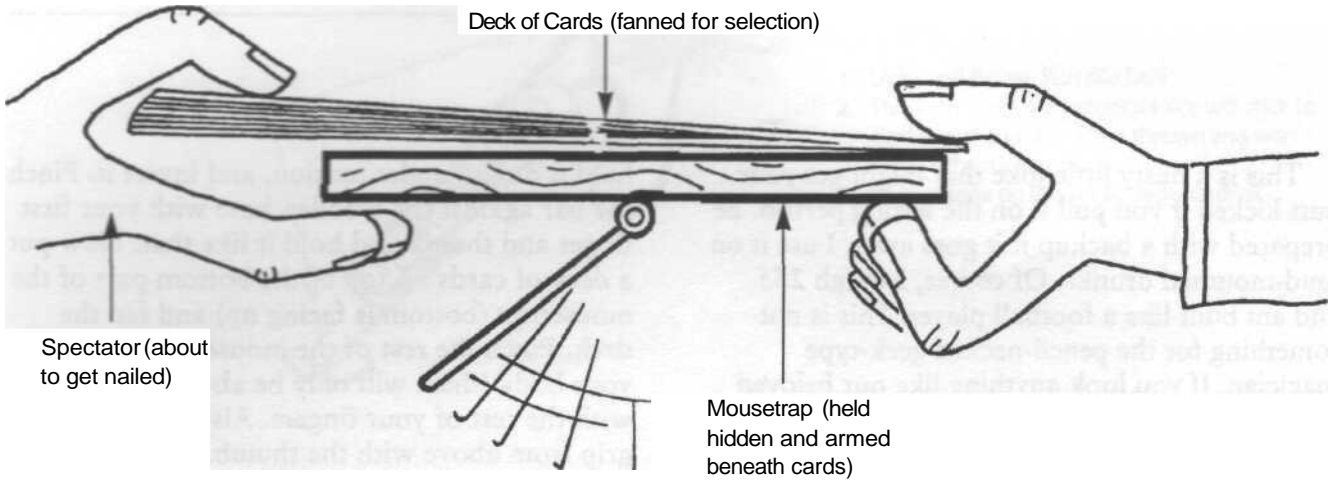

Pinch the fly bar and hold under tension with one finger while your other fingers hold the rest of mousetrap and fanned deck.

IMPACT SMOKE BOMB II

This next type of impact smoke device is chemically initiated. It uses two commonly available chemicals, so you shouldn't have too much trouble building it. These chemicals are ammonia and hydrochloric acid. Ammonia is available from the grocery store, and hydrochloric acid can be purchased at a swimming pool supply outlet. Check the yellow pages.

The containers used for this device are a glass Christmas tree ornament and a test tube. The illustration shows how these two containers fit together and house the chemicals separately. It is very important that the chemicals do not mix. A drop of each is all it takes to produce smoke. I suggest you glue the cork to the test tube and in turn glue the rim of the test tube to the rim of the Christmas ornament. There must be an absolutely airtight seal.

You could add gelatin to the ammonia to stabilize it in the bulb and keep it from sloshing around. This is a good idea if you are going to be carrying it around with you for any length of time. You have less worry about that airtight seal, too. However, for stage use, I don't suggest this. Having gelatin splatter all over the stage doesn't look very professional. But for a dark alley, it won't make a hell of a lot of difference.

It's very simple to operate this device; just throw it down hard so both of the glass

containers break and the chemicals mix. When doing this on stage, I suggest you throw the device onto a large, flat oil pan so you don't leave permanent marks on the stage and end up owing them money.

If you intend to carry this device around with you, try to suspend it from your belt with a string or paper clip. Don't put it in your pocket; there is too great a chance it will break. I deliberately designed this device with the ammonia in the outer container. If hydrochloric acid were in the outer container and the device accidentally broke, you would have serious trouble if it splashed on your skin. Hydrochloric acid in its concentrated form is very caustic and will cause burns.

That's about it for this device. A reliable source in the entertainment industry told me this was the method used in the first *Batman* movie in 1989. Batman uses it during the fight scene in the chemical plant when he is up on the scaffolding. He throws the smoke bomb down and escapes up a rope via some sort of motorized reel. Yes, I'm working on a device like that too. I haven't yet found a strong enough motor that is compact enough to be worn on a belt or carried in a jacket pocket. Maybe I'll have it ready for volume 2. If you have any ideas for it, please write me in care of Paladin Press, P.O. Box 1307, Boulder, CO 80306.

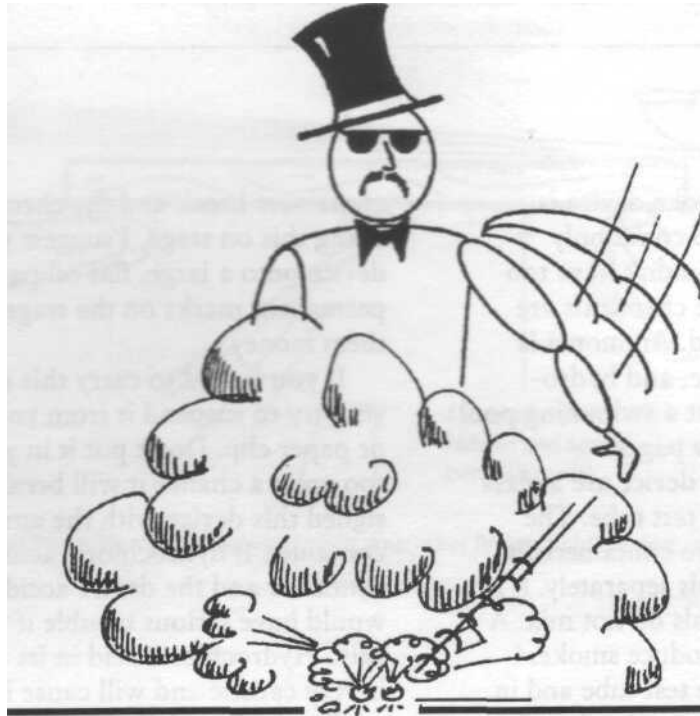

This device will produce heavy white smoke.

IMPACT SMOKE BOMB II

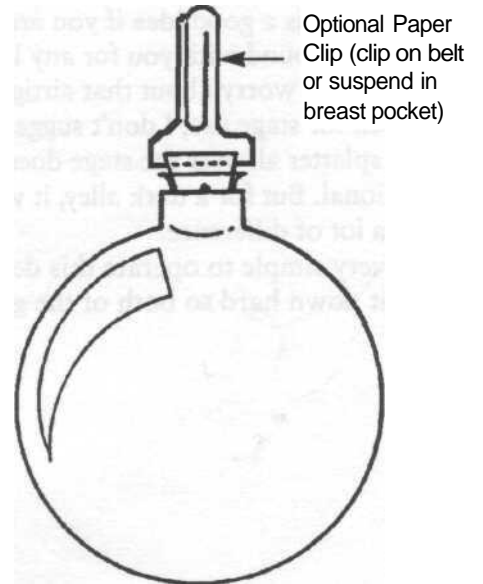
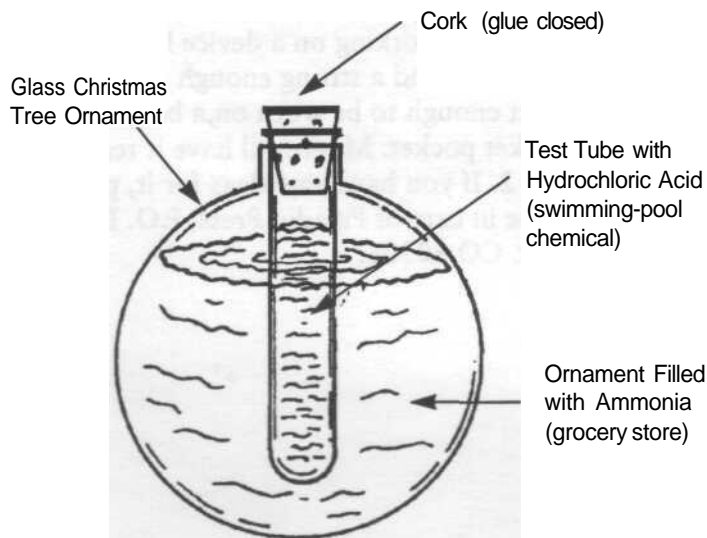

1. The test tube is nested in ornament's mouth.
2. Glue ornament and tube mouths for an air-tight seal. It must have no leaks!

3. Throw the bulb on the ground to break. It produces instant smoke when the chemicals mix.
4. Make several of these and store in an empty egg carton.

APPENDIX A

HOW TO MAKE FLASH PAPER AND FLASH POWDER

FLASH POWDER

Potassium nitrate 2 parts by weight
Powdered magnesium 2 parts by weight

FLASH POWDER (Brilliant Flash)*

Aluminum powder 2 parts by weight
Potassium dichromate 2 parts by weight

RED FLASH POWDER

Powdered magnesium 2 parts by weight
Strontium nitrate 2 parts by weight

GREEN FLASH POWDER

Potassium nitrate 2 parts by weight
Powdered boric acid 2 parts by weight
Powdered magnesium 2 parts by weight
Powdered sulfur 2 parts by weight

*WARNING: You have just made nitrocellulose. Do *not* store large amounts of it.

FLASHPAPER

Prepare a solution of 4 parts sulfuric acid and 5 parts nitric acid in a glass dish. Soak cigarette rolling papers in this mixture for 10 minutes. Remove the papers with a glass rod and wash the acid off. Let them dry. Keep them in a metal box and away from any heat.

COLORED FLASH PAPER

(Prepare as separate solutions.)

Red flash paper	Strontium nitrate
Violet flash paper	Potassium nitrate
Yellow flash paper	Sodium nitrate
Deep green flash paper	Copper chloride
Pale green flash paper	Barium nitrate
Crimson flash paper	Strontium chloride

APPENDIX B

IMPROVISED RADIO DETONATION DEVICES

The following commercially available devices can be modified to remotely detonate an improvised explosive device:

Cellular mobile telephone
Radio paging system (beeper)
Wireless intercom
Toy walkie-talkie
Touch-Tone encoding and decoding system
Cordless telephone
Citizens band radio
FM wireless microphone and portable receiver
Autoalarm paging system
VHF scanner as a receiver

- Audio modulated relay
- Toy remote-controlled car, boat, etc.
- Garage door opener
- Television remote-controlled channel changer

IMPROVISED EXPLOSIVE DEVICES FROM COMMERCIAL BURGLAR ALARMS

Any burglar alarm can be modified into an improvised explosive device triggering system by simply substituting and replacing the existing alarm (audible or silent) bell with the leads of a blasting cap (improvised or commercial). Then put the cap into the explosive, as illustrated.

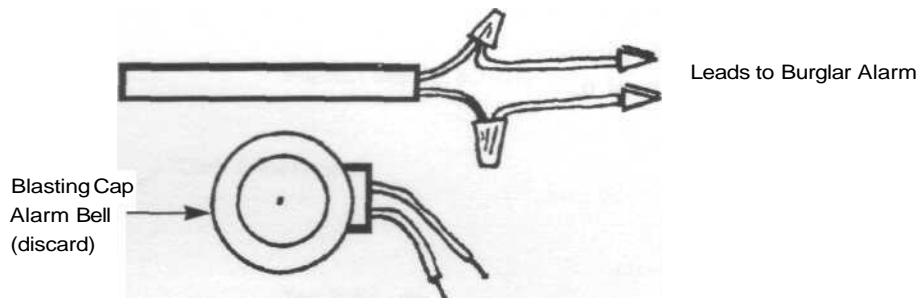

APPENDIX C

INITIATING ACTIONS

Four Main Systems

- Mechanical actions
- Chemical actions
- Friction
- Electrical current

Initiating Actions

Pull—Barometric
Pressure—Delay
Release of pressure—Proximity
Combinations—Controlled
Thermal—Antiwithdrawal
Tilt—Booby-trapped
Antiphoto—Collapsing circuit

Triggering Methods, Fuzing Systems, and Firing Devices

Pressure
Pull
Release of pressure
Combination devices
Tilt
Thermal
Antiphoto

- Barometric
- Delay
 - Clock work
 - Chemical
 - Water drip
 - Expanding seed
 - Material fatigue
 - Electric
 - Electronic
 - Time-fuze
 - Cigarette/matchbook
 - Magnifying glass
- Proximity initiators
 - Vibratory switches
 - Magnetic induction or magnetic movement
 - Photoelectric
- Acoustic
 - Frequency induction
 - Controlled actions
 - Antiwithdrawal and booby-trapped actions
 - Hydrostatic
 - Collapsed circuit
 - Antiprobe circuit
 - Antisubmerge circuit

APPENDIX D

SUPPLY SOURCES

Drugstores and warehouses
Hardware stores
Construction sites
Military magazine areas
Machine shops
Battery shops
Chemistry laboratories
Paint stores
Plumbing and heating suppliers
Hospitals and hospital suppliers
Match manufacturers and factories
Novelty stores
Fireworks stands and sources
Photography suppliers and distributors
Soap and candle makers
Electronic suppliers and distributors
Acetylene and liquid oxygen dealers

- Medical suppliers
- Fertilizer (oxidizer) dealers
- Gunshops
- Magazines (*Popular Science*, classifieds, etc.)
- Hobby shops—The modern hobby shop provides a multitude of supplies and should be checked closely for such supplies as:
 - Fuzing systems (electronic)
 - Incendiaries
 - Chemicals
 - Containers
 - Mechanical timing devices
 - Burning time fuze (hobby fuze)
 - Carbide devices
 - Transmitters and receiving devices (remote-controlled devices)
 - Nichrome wire and glo-plugs

APPENDIX E MAGIC DEALERS

The following magic dealers carry flash paper and other tools of the trade that are used in the devices in this manual. Write to them for copies of their current catalogs.

Hank Lee's Magic Factory
Mail Order Division
P.O. Box 789
Medford, MA 02155

Magic Inc.
5082 N. Lincoln Ave.
Chicago, IL 60625

Tannen's Magic
6 West 32nd St.
New York, NY 10001

Wheeler-Tanner Escapes
3024 E. 35th
Spokane, WA 99223

BIBLIOGRAPHY

Andrews, Val. *Explosive Comedy*. Supreme Magic Publications.

Flashes, Bangs, and Puffs of Smoke: How to Make. Calgary, Alb.: Hades Publications, 1979.

Frankford Arsenal. Improvised Munitions Black Books, Vol. 1, 2, and 3. El Dorado, Ark.: Desert Publications, 1977.

Hampton, Steven. *Advanced Lockpicking Secrets*. by Steven Hampton. Boulder, Colo.: Paladin Press, 1989.

Herbert, Lt. Col. Anthony (Ret.). *Soldier's Handbook*. Cloverleaf Books, 1979.

Lecker, Seymour. *Deadly Brew: Advanced Improvised Explosives*. Boulder, Colo.: Paladin Press, 1987.

_____. *Improvised Explosives: How to Make Your Own*. Boulder, Colo.: Paladin Press, 1985.

_____. *Shock Sensitive Industrial Materials: Advanced Improvised Explosives—Vol. 2*. Boulder, Colo.: Paladin Press, 1988.

Lenz, Charles. *Explosives and Bomb Disposal Guide*. Gettysburg, Penn.: Thomas Publications, 1970.

Lippy, John. *Chemical Magic*.

Long, Hei Master. *21 Techniques of Silent Killing*. Boulder, Colo.: Paladin Press, 1989.

Minnery, John. *How to Kill*, Vol. VI. Boulder, Colo.: Paladin Press, 1984.

_____. *Pick Guns: Lock Picking for Spies, Cops, and Locksmiths*. Boulder, Colo.: Paladin Press, 1989.

_____. *Trapping and Destruction of Executive Armored Cars*. El Dorado, Ark.: Desert Publications, 1980.

Musson, Clettis V. *Fire Magic*. Magic Inc., 1952.

Myers, Lawrence W. *Improvised Radio Detonation Techniques*. Boulder, Colo.: Paladin Press, 1988.

_____. *Smart Bombs: Improvised Sensory Detonation Techniques and Advanced Weapons Systems*. Boulder, Colo.: Paladin Press, 1990.

Principles of Improvised Explosives. Boulder, Colo.: Paladin Press, 1985.

Sharpe, Sam. *Conjuror's Optical Secrets*. Calgary, Alb.: Hades Publications, 1985.

Special Effects with Fire and Smoke: A Technical Manual. Theater Effects, 1985.

Stoffel, Joseph. *Explosives and Homemade Bombs*. Gettysburg, Penn.: Thomas Publications, 1962.

Wilke, Bernard. *Technique of Special Effects in Television*. Stoneham, Mass.: Focal Press, 1989.

Wizard, William. *Pyrotechnics and Visual Effects*. Self-published by author, 1983.